



GOVERNMENT OF PUERTO RICO
DEPARTMENT OF HOUSING

**COMMUNITY DEVELOPMENT BLOCK GRANT – DISASTER RECOVERY (CDBG-DR) /
MITIGATION (CDBG-MIT)**

**AGREEMENT FOR
INCREASE CAPACITY PV SYSTEM, WATER STORAGE SYSTEM
ACQUISITION, AND INSTALLATION SERVICES
FOR COMMUNITY ENERGY AND WATER RESILIENCE INSTALLATION
PROGRAM (CEWRI)
BETWEEN THE
PUERTO RICO DEPARTMENT OF HOUSING
AND
CARIBE TECNO, CRL**



JDPF
JDPF

WORB
WORB

THIS AGREEMENT FOR INCREASE CAPACITY PV SYSTEM, WATER STORAGE SYSTEM ACQUISITION, AND INSTALLATION SERVICES (hereinafter referred to as "**Agreement**") is entered into in San Juan, Puerto Rico, this 19 of December, 2022, by and between the **PUERTO RICO DEPARTMENT OF HOUSING** (hereinafter, "**PRDOH**"), a public agency created under Law No. 97 of June 10, 1972, as amended, 3 L.P.R.A. § 441 *et seq.*, known as the "Department of Housing Governing Act" ("Organic Act") with principal offices at 606 Barbosa Avenue, San Juan, Puerto Rico, herein represented by William O. Rodríguez Rodríguez, attorney, of legal age, single, and resident of San Juan, Puerto Rico, in his capacity as Secretary; and **CARIBE TECNO, CRL** (hereinafter, "**CONTRACTOR**"), with principal offices in 1254 Ave. F. D. Roosevelt, Suite 201, San Juan, Puerto Rico, 00920, herein represented by José D. Pérez Fernández, in his capacity as Authorized Representative, of legal age, married, and resident of Guaynabo, Puerto Rico, duly authorized by Resolution by the CONTRACTOR.

WHEREAS, on September 2017, Hurricanes Irma and María made landfall in Puerto Rico causing catastrophic island wide damage, knocking out power, water, and telecommunications for the entire island and its island municipalities. Hurricane María caused major structure and infrastructure damage to family homes, businesses and government facilities triggering the displacement of thousands of residents of the Island from their homes and jobs.

WHEREAS, under the Continuing Appropriations Act, 2018 and Supplemental Appropriations for Disaster Relief Requirements Act, 2017, signed into law September 8, 2017 (Pub. L. 115-56), \$1.5 billion were allocated by the U.S. Department of Housing and Urban Development (HUD) for disaster recovery assistance to the Government of Puerto Rico under the CDBG-DR. These funds are intended to provide financial assistance to address unmet needs that arise and that are not covered by other sources of financial aid.

WHEREAS, on February 9, 2018, a Notice was published in the Federal Register, Vol. 83, No. 28 (83 FR 5844), that allocated \$1.5 billion for disaster recovery assistance to the Government of Puerto Rico.

WHEREAS, under the Bipartisan Budget Act of 2018, signed into law February 9, 2018 (Pub. L. 115-123), an additional \$8.22 billion were allocated by HUD for disaster recovery assistance to the Government of Puerto Rico under CDBG-DR.

WHEREAS, pursuant to a letter dated February 23, 2018 sent by the former Governor of Puerto Rico to the Secretary of HUD, the PRDOH is the governmental agency designated as grantee of the CDBG-DR funds allocated to the Government of Puerto Rico.

WHEREAS, on August 14, 2018, a Notice was published in the Federal Register Vol. 83, No. 157, (83 FR 40314) that made an additional allocation to Puerto Rico of \$8.22 billion for recovery. With these allocations of funding, the PRDOH aims to lead a transparent, comprehensive recovery to benefit the residents of Puerto Rico. PRDOH holds accountability and is committed to the responsible, efficient, and transparent administration of CDBG-DR grant funding.

WHEREAS, On September 20, 2018, the Governor of Puerto Rico and the Secretary of HUD signed the Grant Agreement.

WHEREAS, under the Further Additional Supplemental Appropriations Act for Disaster Relief Requirements Act, 2018, (Division B, Subdivision 1 of the Bipartisan Budget Act of 2018, Pub. L. 115-123, approved February 9, 2018), \$8.285 billion were allocated by the U.S. Department of Housing and Urban Development (HUD) for mitigation activities and assistance to the Government of Puerto Rico under the Community Development Block Grant – Mitigation (CDBG-MIT) Program. These funds are intended to provide financial assistance in areas impacted by recent disasters. Moreover, CDBG-MIT funds represent a unique and significant opportunity for Puerto Rico to carry out strategic and high-impact activities to mitigate disaster risks and reduce future losses.

WHEREAS, on August 30, 2019, a Notice was published in the Federal Register, Vol. 84, No. 169, (84 Fed. Reg. 45838), which described the grant requirements and procedures applicable to future allocations of CDBG-MIT funds to the Government of Puerto Rico.

WHEREAS, on May 12, 2021, the PRDOH Secretary and the Secretary of HUD signed Grant Agreement Number B-18-DP-72-0002; allowing PRDOH access to \$8,285,284,000 in CDBG-MIT funding, obligated under Pub. L. 115-123, as amended.

WHEREAS, the PRDOH is the government agency designated as grantee of the CDBG-MIT funds allocated to the Government of Puerto Rico.

WHEREAS, the PRDOH is interested in contracting a qualified vendor to assist PRDOH with Photovoltaic Systems (**PV Systems**) and Water Storage system acquisition and installation Services for the Community Energy and Water Resilience Installation (**CEWRI**) Program under the CDBG-DR Program. These activities are specifically intended for the equipment and installation of PV Systems and Water Storage systems or homes that have been repaired or reconstructed under the Home Repair, Reconstruction, or Relocation Program (**R3**) and Social Interest Housing Program (**SHI**). This firm will support PRDOH's objectives of ensuring compliance with all CDBG-DR/MIT, HUD and applicable federal and local requirements, rules and regulations, as well as in PRDOH's objectives of the Action Plan, as amended, and adequately coordinating and monitoring all CDBG-DR related activities.

WHEREAS, on January 21, 2022 the PRDOH issued an Invitation for Bid (**IFB**) No. CDBG-DR-IFB-2022-03 for "**Increase Capacity PV System, Water Storage System Acquisition, And Installation Services**" with CDBG-DR and CDBG-MIT funds. This request was placed through the CDBG-DR website and the "Registro Único de Subastas" ("**RUS**", by its Spanish acronym). Afterwards, PRDOH requested Quotations or Proposals from qualified Proposers therein registered. Through this procurement process, PRDOH was able to reach **twelve (12)** qualified firms listed for their capacity and experience with federal grants to deliver qualified services.

JDPF
JDPF

WORR
WORR

WHEREAS, on March 18, 2022, the CONTRACTOR submitted a proposal (hereinafter referred to as the "**Proposal**"), which fully complied with the requirements set forth by the PRDOH.

WHEREAS, on August 23, 2022, **CARIBE TECNO, CRL** was chosen to perform the required services at a reasonable proposed cost to assist PRDOH in the Puerto Rico's recovery efforts according to the award criteria established in the IFB.

WHEREAS, the PRDOH desires to enter into an agreement with **CARIBE TECNO, CRL** to secure its services and accepts the CONTRACTOR's Proposal and costs, and the CONTRACTOR by its acceptance of the terms and conditions of this Agreement is ready, willing and able to provide the requested services contemplated under this Agreement.

NOW THEREFORE, in consideration of the mutual promises and the terms and conditions set forth herein, the PRDOH and the CONTRACTOR agree as follows:

I. TYPE OF CONTRACT

Contract Type: This is a unit and system price contract. Under this Agreement, CONTRACTOR shall submit monthly invoices to the PRDOH based on the Cost Form (**Attachment C**) and as the services are rendered. Any and all changes and/or modifications to this Agreement shall be in writing and must be signed by both parties.

Attachments Incorporated: The following attachments are incorporated into this Agreement by reference and are hereby made part of this Agreement:

Attachment A	Proposal
Attachment B	Scope of Work
Attachment C	Cost Form
Attachment D	Performance Requirements
Attachment E	Insurance Requirements
Attachment F	HUD General Provisions
Attachment G	Contractor Certification Requirement
Attachment H	Labor Agreement
Attachment I	HUD Form 4010 (English and Spanish version)
Attachment J	SAM Wage Determination
Attachment K	Non-Conflict of Interest Certification

All Attachments hereto are fully incorporated herewith such that the terms and conditions of the Attachments shall be as binding as any terms and conditions of this executed written Agreement. Should any inconsistency appear between the Attachments and this Agreement, the Agreement shall prevail.

II. TERM OF AGREEMENT

- A.** This Agreement shall be in effect and enforceable between the parties from the date of its execution. The Term of this Agreement will be for a performance period of **twenty-four (24) months**, ending on December, 19, 20²⁴.
- B. Contract Extensions:** PRDOH may, at its sole discretion, extend the Agreement's term for **one (1)** additional term of **twelve (12) months**, or expressed in days, **three hundred sixty-five (365) days** upon mutual written agreement of the parties.

JDPF
JDPF

WORR
WORR

- C. The term of this Agreement shall not exceed the lifetime of the initial Grant Agreement between PRDOH and HUD, unless the term of the initial Grant Agreement is extended by HUD, in which case the Agreement shall not exceed said extended period.

III. SCOPE OF WORK

The CONTRACTOR will provide the services described in **Attachment B** of the Agreement. The parties agree that the CONTRACTOR shall furnish all permits, consents, licenses, equipment, software and supplies necessary to perform the Services, at CONTRACTOR's sole cost.

IV. COMPENSATION AND PAYMENT

- A. The PRDOH agrees to pay the CONTRACTOR for allowable Services rendered under this Agreement in accordance with the rates and amounts described in **Attachment C** of this Agreement.
- B. The PRDOH will pay the CONTRACTOR, for allowable services performed during the term of this Agreement, a maximum amount not to exceed **TWENTY-NINE MILLION SIX HUNDRED SEVENTY-THREE THOUSAND DOLLARS (\$29,673,000.00)**; **Account Number: R02H14HER-DOH-LM 6090-01-000.**
- C. Such payment shall be compensation for all allowable services required, performed and accepted under this Agreement included in **Attachment C** and **Attachment D**.
- D. Any additional funds to complete the services requested by the PRDOH to the CONTRACTOR will be subject to evaluation before acceptance as well as funds availability and will require an amendment to this Agreement.
- E. The CONTRACTOR shall submit an invoice to PRDOH on a monthly basis. Said invoice must be submitted including all required invoice supporting documents, including but not limited to monthly reports, timesheets, invoice and photos evidence, expense plan and/or work projections. If PRDOH determines that the submitted invoice and supporting documents are acceptable, then the invoice will be approved for payment.
- F. The services rendered under the Agreement, shall be payable within forty-five (45) business days from the date the invoice is received and approved by a PRDOH representative for payment. If PRDOH raises any objections, PRDOH will return the invoice for corrections and the CONTRACTOR shall modify the invoice and return it within five (5) business days. Once the CONTRACTOR returns the modified invoice, the PRDOH shall resume and conclude the payment process within the next forty-five (45) business days.
- G. An authorized representative of the PRDOH will review each invoice and, if adequate, will approve and process its payment. Payments to the CONTRACTOR shall be made by electronic funds transfer (EFT). PRDOH reserves the right to conduct any audits it deems necessary. The CONTRACTOR agrees to cooperate fully with any such audit or audits.

JDPF
JDPF

WORR
WORR

- H. While providing the services under this Agreement, the CONTRACTOR must adhere to applicable requirements of the CDBG-DR grant. If the CONTRACTOR performs ineligible activities under the CDBG-DR grant or program, the CONTRACTOR cannot include them in the invoice for payment to the CONTRACTOR.
- I. CONTRACTOR shall be liable to the PRDOH for any costs disallowed pursuant to financial and/or compliance audit(s) of funds received under this Agreement. CONTRACTOR shall reimburse such disallowed costs from funds other than those CONTRACTOR received under this Agreement.
- J. The CONTRACTOR acknowledges and agrees to repay any CDBG-DR funds used for ineligible costs.
- K. Extended overhead costs is an Ineligible cost under this Agreement and shall not be reimbursable.
- L. In order for the CONTRACTOR to receive payment for any work performed hereunder, the following certification must be included in each application for payment or invoice submitted to the PRDOH for payment:

“Under penalty of absolute nullity, I hereby certify that no public servant of the government entity is a party to or has an interest of any kind in the profits or benefits to be obtained under the contract which is the basis of this invoice, and should he be a party to, or have an interest in, the profits or benefits to be obtained under the contract, a waiver has been previously issued. The only consideration to provide the contracted goods or services under the contract is the payment agreed upon with the authorized representative of the government entity. The amount that appears in the invoice is fair and correct. The work has been performed, the goods have been delivered, and the services have been rendered, and no payment has been received therefor.”

V. REIMBURSABLE EXPENSES

The PRDOH will not reimburse any costs incurred by the CONTRACTOR not included in the approved Proposal or in an executed written amendment.

VI. ADDITIONAL SERVICES

Should additional services be needed by the PRDOH, such additional services shall be agreed upon by the parties in a written document signed by both parties, prior to the issuance of a notice to proceed with the performance of such additional services.

VII. OWNERSHIP AND USE OF DOCUMENTS

- A. With the exception of the CONTRACTOR's working papers, the CONTRACTOR acknowledges the PRDOH's ownership of all information, drafts, documents, reports, papers, and other materials developed and prepared by the CONTRACTOR, its agents or representatives, for purposes of performing key obligations hereunder. In the event of any termination, the CONTRACTOR shall deliver such information, drafts, reports, papers and other materials to the PRDOH, in document form or as computer program data, and the CONTRACTOR recognizes the PRDOH's right to request such

JDPF
JDPF

WRR
WRR

documentation or computer program data. If the CONTRACTOR fails to deliver said information, the PRDOH may seek a judicial order to enforce its rights.

- B. Proof of expenditures incurred by the CONTRACTOR on behalf of PRDOH shall be made available to PRDOH. The CONTRACTOR agrees to maintain accurate records and files of all contract documents, correspondence, book estimates, bills, and other information related to the CONTRACTOR account. These documents shall be open for the PRDOH examination at all reasonable times during the term of this Agreement, and up to **five (5) years** from closeout of the grant to the state, or the period required by other local applicable laws and regulations.

VIII. DOCUMENTATION AND RECORKEEPING

- A. **Records to be Maintained:** The CONTRACTOR shall maintain records of the state and units of general local government, including supporting documentation, which shall be retained for the greater of **five (5) years** from closeout of the grant to the state, or the period required by other local applicable laws and regulations. Such records include but are not limited to: Records providing a full description of each activity undertaken; Records demonstrating that each activity undertaken meets one of the National Objectives of the CDBG-DR ad CDBG-MIT program; Records required to determine the eligibility of activities; Records required to document the acquisition, improvement, use or disposition of real property acquired or improved with CDBG-DR assistance; Records documenting compliance with the fair housing and equal opportunity requirements of the CDBG-DR program regulations; Financial records as required by 24 C.F.R. § 570.506, and 2 C.F.R. part 200, including records necessary to demonstrate compliance with all applicable procurement requirements; and other records necessary to document compliance with this agreement, any other applicable Federal statutes and regulations, and the terms and conditions of PRDOH's Federal award.
- B. **Access to Records:** The CONTRACTOR shall permit the PRDOH and auditors to have access to the CONTRACTOR's records and financial statements as necessary for the PRDOH to meet its audit requirements under the Federal award.
- C. **Record Retention and Transmission of Records to the PRDOH:** Prior to close out of this Agreement, the CONTRACTOR must transmit to the PRDOH records sufficient for the PRDOH to demonstrate that all costs under this Agreement met the requirements of the Federal award.
- D. **CONTRACTOR's Data and Privileged Information:** The CONTRACTOR is required to maintain confidential data demonstrating client eligibility for activities provided under this Agreement. Such data may include, but not be limited to, client name, address, income level or other basis for determining eligibility, and description of activities provided.
- E. **PII Policy:** The CONTRACTOR must comply with the PRDOH CDBG-DR Personal Identifiable Information Policy, as found in the CDBG-DR Website (www.cdbg-dr.pr.gov), which is herein included and made integral part of this Agreement, as it may be updated from time to time.

JDPF
JDPF

WARR
WARR

IX. ACCESS TO RECORDS

- A. The CONTRACTOR agrees to provide the Government of Puerto Rico, PRDOH, HUD's Secretary, the Comptroller General of the United States, or any of their authorized representative's access to any books, documents, papers, and records of the CONTRACTOR which are directly pertinent to this Agreement for the purposes of making audits, examinations, excerpts, and transcriptions.
- B. The CONTRACTOR agrees to permit any of the foregoing parties to reproduce by any means whatsoever or to copy excerpts and transcriptions as reasonably needed.

X. NON-DISCLOSURE AND CONFIDENTIALITY

- A. **Confidential Information; Definition:** The term Confidential Information as used throughout this Section, means any information concerning PRDOH operations and that of its CONTRACTOR (e.g., the projects, computer processing systems, object and source codes and other PRDOH business and financial affairs). The term Confidential Information shall also deem to include all notes, analysis, compilation, studies and interpretation or other documents prepared by CONTRACTOR, its agents or representatives, in connection with PRDOH operations.
- B. **Non-Disclosure:** CONTRACTOR agrees to take all reasonable steps or measures to keep confidential all Confidential Information and will not, at any time, present or future, without PRDOH express written authorization, signed by the Secretary of the PRDOH, use or sell, market or disclose any Confidential Information to any third party, contractor, corporation, or association for any purpose whatsoever. CONTRACTOR further agrees that, except as they relate to the normal course of the service, the CONTRACTOR will not make copies of the Confidential Information except upon PRDOH express written authorization, signed by an authorized representative of PRDOH, and will not remove any copy or sample of Confidential Information without prior written authorization from PRDOH. CONTRACTOR retains the right to control its work papers subject to these confidentiality provisions.
- C. **Return Documents:** Upon receipt of written request from the PRDOH, CONTRACTOR will return to PRDOH all copies or samples of Confidential Information which, at the time of the notice are in CONTRACTOR's or its agent's possession. CONTRACTOR reserves the right to retain a set of its work papers.
- D. **Equitable Relief:** The CONTRACTOR acknowledges and agrees that a breach of the provision of subparagraph B and C of this Section will cause PRDOH to suffer irreparable damage that could not be remedied or compensated adequately only by mere monetary retribution. The CONTRACTOR further agrees that money damages may not be a sufficient remedy for any breach of this Section. Accordingly, the CONTRACTOR agrees that PRDOH shall have the right to seek injunctive relief and the specific performance of the provisions of this Section to enjoin a breach or attempted breach of the provision hereof, such right being in addition to any and all other rights and remedies that are available to PRDOH by law, equity, or otherwise.

XI. PERFORMANCE WARRANTY

- (a) CONTRACTOR warrants that it will perform all work and provide all Deliverables under this Contract in a manner consistent with the degree of care and skill

JDPF
JDPF

WORR
WORR

ordinarily exercised by members of the same profession currently practicing under similar circumstances.

- (b) CONTRACTOR warrants that all Deliverables it completes under this Contract shall: meet or exceed the standards of CONTRACTOR's trade, profession, or industry; meet or exceed the specifications set forth in the Attachments to this Agreement; and be fit for ordinary use, of good quality, and with no material defects.
- (c) If CONTRACTOR submits Deliverables that do not meet specifications, fails to complete Deliverables timely, or fails to perform its obligation under this Contract, PRDOH may require CONTRACTOR, at its sole expense, to:
1. repair or replace Deliverables that do not meet specifications;
 2. refund payment for Deliverables that do not meet specifications and accept the return of such Deliverables;
 3. pay liquidated damages for any past due Deliverable; and
 4. take necessary action to ensure that future performance and Deliverables meet specifications and conform to the Contract.



JDPF
JDPF

WORR
WORR

XII. TERMINATION

- A. Termination for Cause or Default:** The PRDOH may terminate this Agreement, in whole or in part, because of CONTRACTOR's failure to fulfill any of its obligations. The PRDOH shall terminate this Agreement by delivering to the CONTRACTOR a **thirty (30) calendar day** notice of termination specifying the extent to which the performance of the service under this Agreement is terminated, the reason therefor and the effective date of termination. CONTRACTOR shall, upon written notice, be provided a **ten (10) calendar day** opportunity to cure the alleged defect that resulted in the perceived default. If the defect is not cured within that period of time, CONTRACTOR shall immediately discontinue all such services being terminated and deliver to the PRDOH all information, notes, drafts, documents, analysis, reports, compilations, studies and other materials accumulated or generated in performing the services contemplated in this Agreement, whether completed or in process. Notwithstanding the above, the CONTRACTOR shall not be relieved of liability to the PRDOH for damage sustained to PRDOH CDBG-DR Program by virtue of any breach of the Agreement by the CONTRACTOR. The PRDOH may withhold any payments to the CONTRACTOR, for the purpose of off-set or partial payment, as the case may be, of amounts owed to the PRDOH by the CONTRACTOR. PRDOH shall make payment, in accordance with the terms of this Agreement, of any amounts due to CONTRACTOR for allowable services rendered prior to the termination notice.
- B. Termination for Convenience:** The PRDOH may terminate this Agreement, in whole or in part, whenever the PRDOH determines that such termination is necessary or convenient to the Agency. The PRDOH will terminate this Agreement by delivering to the CONTRACTOR a **thirty (30) calendar day** notice of termination specifying the extent to which the performance of the work under this Agreement is terminated, and the effective date of termination. Upon receipt of such notice, the CONTRACTOR shall immediately discontinue all services affected and deliver to the PRDOH all information, studies and other materials property of the PRDOH. In the event of a termination by Notice, the PRDOH shall be liable only for payment of services rendered up to and including the effective date of termination. PRDOH shall make payment, in accordance with the terms of this Agreement, of any amounts due to CONTRACTOR for allowable services rendered prior to the termination notice.
- C. Termination by Unilateral Abandonment:** The PRDOH will consider this Agreement immediately terminated, in the event that the CONTRACTOR unilaterally and without

prior notice, chooses to abandon (in any shape, form or fashion) cease and desist in the specific performance of its general and particular duties and responsibilities as agreed in this Agreement. Upon the knowledge of such event, the PRDOH will not be held liable and will immediately, automatically and retroactively deduct from any future reimbursement, all funds from the day such unilateral abandonment took place. The PRDOH will not be compelled to continue the performance of the Agreement, should the CONTRACTOR breach the Agreement by unilateral abandonment. For the purposes of this Section, Abandonment shall mean that CONTRACTOR voluntarily and intentionally disavows its contractual duties in a manner that is overt and without question a relinquishment of said contractual duties.

- 
JDPF
- 
WORR
- D. Unilateral Termination:** The PRDOH may terminate this Agreement, in whole or in part, at PRDOH's sole discretion, with or without cause, at any time. The PRDOH will terminate this Agreement by delivering to the CONTRACTOR a **thirty (30) calendar day** notice of termination specifying the extent to which the performance of the work under this Agreement is terminated, and the effective date of termination. Upon receipt of such notice, the CONTRACTOR shall immediately discontinue all services affected and deliver to the PRDOH all information, studies and other materials property of the PRDOH. In the event of a termination by Notice, the PRDOH shall be liable only for payment of services rendered up to and including the effective date of termination.
- E. Suspension:** The PRDOH may suspend this Agreement in whole or in part at any time for the PRDOH's convenience. The PRDOH shall give the CONTRACTOR **five (5) business days'** written notice of such suspension. Upon receipt of said notice the CONTRACTOR shall immediately discontinue all Services affected.
- F. Immediate Termination:** In the event the CONTRACTOR is subjected to a criminal or civil action, suit, proceeding, inquiry or court of applicable jurisdiction, or any governmental agency, or the CONTRACTOR shall be subject to an order, judgment, or opinion, issued by any federal or local authority, a court of applicable jurisdiction, or any governmental agency, in connection with the execution, delivery, and performance by the CONTRACTOR of this Agreement or the CONTRACTOR of this Agreement has been noncompliant, breach, inaccuracy of any representation, warranties, covenants, or the certifications provided herein, whether the noncompliance, breach or inaccuracy takes place before or after the execution of this Agreement, the PRDOH shall have the right to the immediate termination of this Agreement notwithstanding, any provisions to the contrary herein. This Section will apply in the event of any judgment that may obligate the PRDOH to terminate the Agreement pursuant to Act Number 2 of January 2, 2018, as amended, known as the Anti-Corruption Code for the New Puerto Rico.
- G. Period of Transition:** Upon termination of this Agreement, and for **ninety (90) consecutive calendar days** thereafter (the Transition Period), CONTRACTOR agrees to make himself available to assist the PRDOH with the transition of services assigned to CONTRACTOR by the PRDOH. CONTRACTOR shall provide to the PRDOH the assistance reasonably requested to facilitate the orderly transfer of responsibility for performance of the Services to the PRDOH or a third party designated by the PRDOH. PRDOH reserves the right to provide for the execution of a Transition Services Agreement for the Transition Period. In such instance, the CONTRACTOR will be paid at a reasonable, agreed upon, hourly rate for any work performed for the PRDOH during the Transition Period. Moreover, during that Transition Period, all finished or

unfinished records (files, data, work product) connected with this Agreement will be turned over to PRDOH.

XIII. PENALTIES AND LIQUIDATED DAMAGES

A. Penalties

1. In the event the CONTRACTOR is determined to have engaged in any proscribed conduct or otherwise is in default as to any applicable term, condition, or requirement of this Agreement, at any time following the Effective Date of the Agreement, the CONTRACTOR agrees that, PRDOH may impose sanctions against the CONTRACTOR for any default in accordance with **Attachment B** and **Attachment D** and this Section. Refer to all required provisions set forth at 2 C.F.R. § 200.326 and 24 C.F.R. § 570.489(g), if applicable, and the Contract and Subrecipient Agreement Manual , Section 2, Subsection 2.4.1(a), as found in the CDBG-DR Website (www.cdbg-dr.pr.gov) which is herein included and made integral part of this Agreement, as it may be updated from time to time.

2. If the CONTRACTOR fails to comply with federal statutes, regulations or the terms and conditions of the Agreement, PRDOH may take one or more of the following actions:
 - i. Temporarily withhold cash payments pending correction of the deficiency by the CONTRACTOR.
 - ii. Disallow all or part of the cost of the activity or action not in compliance.
 - iii. Initiate suspension or debarment proceedings as authorized under 2 C.F.R. part 180.
 - iv. Withhold further Federal awards for the project or program.
 - v. Take other remedies that may be legally available.

B. Liquidated damages

The CONTRACTOR shall pay to PRDOH, as liquidated damages, as related to their timeframes of performance. The PRDOH and the CONTRACTOR will agree on the timetable for the deliverable of each task. The CONTRACTOR shall pay to PRDOH, as liquidated damages, the amount established below for each calendar day that a deliverable required is late until deemed in compliance subject to a maximum of amount as established below.

Type of Work	Liquidated Damages for each calendar day	Maximum Amount of Liquidated Damages per occurrence, deliverable and task.
PV System Equipment, Installation, and related services	\$500.00	\$5,000.00
WSS Equipment, Installation, and related services	\$100.00	\$1,000.00

JDPF
JDPF

WORR
WORR

Said sum, in view of the difficulty of accurately ascertaining the loss which PRDOH will suffer by reason of delay in the completion of the Work hereunder, is hereby fixed and agreed as the liquidated damages that PRDOH will suffer by reason of such delay. Liquidated damages received hereunder are not intended to be nor shall they be treated as either a partial or full waiver or discharge of the PRDOH's right to indemnification, or the CONTRACTOR's obligation to indemnify the PRDOH pursuant to this Contract, or to any other remedy provided for in this Contract or by Law. Liquidated damages may be assessed at the sole discretion of PRDOH. For the purpose of applying and calculating such liquidated damages, a grace period of **ten (10) business days** shall be observed. The PRDOH may deduct and retain out of the monies which may become due hereunder, the amount of any such liquidated damages; and in case the amount which may become due hereunder shall be less than the amount of liquidated damages due to the PRDOH per the formula above, the CONTRACTOR shall be liable to pay the difference.

JDPF
JDPF

WORR
WORR

XIV. LIABILITY

In no event, the PRDOH shall be liable for any indirect, incidental, special or consequential damages, or damages for loss of profits, revenue, data or use, incurred by either party or any third party, whether in an action in contract or tort, even if the other party or any person has been advised of the possibility of such damages. Third parties operating under this program, with their agency, will have their own general civil and criminal liability imposed by law towards the PRDOH, the CONTRACTOR and any citizen.

The CONTRACTOR shall carry the insurances as are required by law (if applicable), as set forth below. The CONTRACTOR shall furnish PRDOH certificates of insurance.

XV. INSURANCE

A. Required Coverage

The CONTRACTOR shall keep in force and effect for the period beginning from the execution of the Agreement and ending at the completion of all services to be provided hereunder, insurance policies in compliance with the Insurance Requirements, attached hereto and made an integral part hereof as **Attachment E**. The CONTRACTOR shall meet all other insurance requirements as may be imposed by PRDOH from time to time.

PRDOH will execute this Agreement conditioned to the submission, within thirty **(30)** days of the signing of this Agreement, of the following insurance policies:

- State Insurance Fund
- Commercial General Liability
- Auto Liability
- Professional Liability
- Umbrella
- Employment Practices Liability
- Pollution
- Builder's Risk
- Payment & Performance Bond

Failure to comply with the submission of the aforementioned insurance may result in the termination of the Agreement.

Upon the execution of this Agreement, the CONTRACTOR shall furnish PRDOH with original and two (2) certified copies of the insurance policies described in **Attachment E** and any other evidence PRDOH may request as to the policies' full force and effect.

Any deductible amount, under any of the policies, will be assumed in whole by the CONTRACTOR for any and all losses, claims, expenses, suits, damages, costs, demands or liabilities, joint and several of whatever kind and nature arising from the Agreement resulting from this solicitation by and between the CONTRACTOR and PRDOH.

The PRDOH shall not be held responsible under any circumstances for payments of any nature regarding deductibles of any Commercial Liability Policies for the aforementioned Agreement.

JDPF
JDPF

B. Endorsements

Each insurance policy maintained by the CONTRACTOR must be endorsed as follows:

1. PRDOH, Government of Puerto Rico, HUD and its officers, agents and employees are named as additional insured (except Worker's Compensation) but only with respect to liability arising out of tasks performed for such insured by or on behalf of the named insured.
2. To provide waiver of subrogation coverage for all insurance policies provided or herein in favor of PRDOH and its respective officers, agents and employees.
3. The insurer shall be required to give PRDOH written notice at least **thirty (30) days** in advance of any cancellation in any such policies.

The CONTRACTOR shall furnish to PRDOH, prior to commencement of the work, certificates of insurance from insurers with a rating by the A.M. Best Co. of B+ and five (5) or over on all policies, reflecting policies in force, and shall also provide certificates evidencing all renewals of such policies. Insurers shall retain an A.M. Best Co. rating of B+ and five (5) or over on all policies throughout the term of this Agreement and all policy periods required herein. The insurance company must be authorized to do business in Puerto Rico and be in good standing.

C. Related Requirements

The CONTRACTOR shall furnish original Certificates of Insurance evidencing the required coverage to be in force on the Effective Date of Agreement. In the case of Payment and Performance Bond, Certificate of Authority, Power of Attorney and Power of Attorney License issued by the Commissioner of Insurance shall be furnished. THE REQUIRED DOCUMENTATION MUST BE RECEIVED PRIOR TO THE CONTRACTOR COMMENCING WORK. NO CONTRACTOR OR ITS AUTHORIZED REPRESENTATIVES ARE TO BEGIN THEIR RESPONSIBILITIES UNDER THE AGREEMENT PRIOR TO FULL COMPLIANCE WITH THIS REQUIREMENT AND NOTIFICATION FROM PRDOH TO PROCEED.

Renewal Certificates of Insurance or such similar evidence is to be received by the Contract Administration of the Legal Division and/or the Finance area of the CDBG-DR and CDBG-MIT program prior to expiration of insurance coverage. At PRDOH's option, non-compliance will result in one or more of the following actions: (1) The PRDOH will purchase insurance on behalf of the CONTRACTOR and will charge back all cost to the

WDRR
WDRR

CONTRACTOR; (2) all payments due the CONTRACTOR will be held until the CONTRACTOR has complied with the Agreement; and/or (3) The CONTRACTOR will be assessed **Five Thousand Dollars (\$5,000.00) for every day of non-compliance.**

The receipt of any certificate does not constitute agreement by PRDOH that the insurance requirements in the Agreement have been fully met or that the insurance policies indicated on the certificate are in compliance with the requirements of the Agreement. The insurance policies shall provide for **thirty (30) days** written notice to be given to PRDOH in the event coverage is substantially changed, cancelled or non-renewed.

The CONTRACTOR shall require all subcontractors or consultants to carry the insurance required herein or the CONTRACTOR, may provide the coverage for any or all of its subcontractors and if so, the evidence of insurance submitted shall so stipulate and adhere to the same requirements and conditions as outlined above.

The CONTRACTOR expressly understands and agrees that whenever the CONTRACTOR is covered by other primary, excess, or excess contingent insurance that, any insurance or self-insurance program maintained by PRDOH shall apply in excess of and will not contribute with insurance provided by the CONTRACTOR under this Agreement.

XVI. HOLD HARMLESS

The CONTRACTOR and its affiliates, its successors and assignees will indemnify the PRDOH from any damages and/or losses arising out of any breach of this Agreement by the CONTRACTOR or against personal injuries or property damage resulting from any act of negligence or omission by the CONTRACTOR and its affiliates in connection with this Agreement.

XVII. FORCE MAJEURE

In the event of a fire, flood, earthquake, natural disaster, hurricane, riot, act of governmental authority in its sovereign capacity, pandemic officially declared by the Government of Puerto Rico, strike, labor dispute or unrest, embargo, war, insurrection or civil unrest, any *Force Majeure* including inclement weather, herein collectively referred to as *Force Majeure* during the term of this Agreement, neither the PRDOH nor the CONTRACTOR shall be liable to the other party for nonperformance during the conditions created by such event.

The CONTRACTOR shall notify, as soon as possible, the PRDOH of the occurrence of the *Force Majeure* event and describe in reasonable detail, the nature of the *Force Majeure* event.

XVIII. CONFLICTS OF INTEREST

The CONTRACTOR shall comply with the ethics requirements set forth herein and warrant that to the best of its knowledge and belief and except as otherwise disclosed, it does not have any organizational conflict of interest which is defined as a situation in which the nature of the work under a PRDOH contract and CONTRACTOR'S organizational, financial, contractual or other interest are such that:

- a) Award of the Agreement may result in an unfair competitive advantage; or
- b) The CONTRACTOR's objectivity in performing the contract work may be

JDPF
JDPF

WORR
WORR

impaired.

The CONTRACTOR agrees that if after award he or she discovers an organizational conflict of interest with respect to this Agreement, it shall make an immediate (within the next **seventy-two (72) hours**) and full disclosure in writing to the Contracting Officer, which shall include a description of the action, which the CONTRACTOR has taken or intends to take to eliminate or neutralize the conflict. The CONTRACTOR will disclose the details of any existing or future contract to provide services to third parties participating or for the purpose to participate in disaster recovery programs or projects in Puerto Rico. The PRDOH may, however, terminate the Agreement for the convenience of PRDOH if it would be in its best interest.

JDPF
JDPF

In the event the CONTRACTOR was aware of an organizational conflict of interest before the award of this Agreement and did not disclose the conflict to the Contracting Officer, the PRDOH may terminate the Agreement for default.

WORR
WORR

The provisions of this clause shall be included in all subcontracts and/or consulting agreements wherein the work to be performed is similar to the services provided by the CONTRACTOR. The CONTRACTOR shall include in such subcontracts and consulting agreements any necessary provision to eliminate or neutralize conflicts of interest.

XIX. INDEPENDENT CONTRACTOR

The relationship of the CONTRACTOR to PRDOH shall be that of an independent CONTRACTOR rendering professional services. Neither the CONTRACTOR nor any personnel of the CONTRACTOR shall have any authority to execute contracts or make commitments on behalf of PRDOH. Nothing contained herein shall be deemed to create the relationship of employer/employee, principal/agent, joint venture or partner between the CONTRACTOR and PRDOH. Further, the CONTRACTOR recognizes that in view of its status as an independent CONTRACTOR, neither it nor its employees or subcontractors will be entitled to participate in or receive any fringe benefits normally granted to PRDOH employees under such programs, including, but not limited to, worker's compensation, voluntary disability, travel accident insurance, medical/dental insurance, life insurance, long-term disability, holiday pay, sick pay, salary continuation pay, leaves of absence (paid or unpaid), pension plan and savings plan.

The CONTRACTOR shall have exclusive control over its employees and subcontractors (and the CONTRACTOR's employees and subcontractors are herein, collectively, referred to as the "CONTRACTOR Personnel"), its labor and employee relations and its policies relating to wages, hours, working conditions and other employment conditions. The CONTRACTOR has the exclusive right to hire, transfer, suspend, lay off, recall, promote, discipline, discharge and adjust grievances with its CONTRACTOR Personnel. The CONTRACTOR is solely responsible for all salaries and other compensation of its CONTRACTOR Personnel who provide Services.

The CONTRACTOR is solely responsible for making all deductions and withholdings from its employees' salaries and other compensation and paying all contributions, taxes and assessments, including union payments. The CONTRACTOR shall be responsible for and shall defend, indemnify and hold harmless PRDOH, and its agents, officers, directors, employees, representatives, CONTRACTOR's, successors and assigns against all costs, expenses and liabilities, including without limitation reasonably prudent attorneys' fees relative to the situation, in connection with the CONTRACTOR's employment and/or hiring of any CONTRACTOR Personnel providing any of the Services, including without

limitation: (i) payment when due of wages and benefits, (ii) withholding of all payroll taxes, including but not limited to, unemployment insurance, workers' compensation, FICA and FUTA, (iii) compliance with the Immigration Reform Control Act, and (iv) compliance with any other applicable laws relating to employment of any CONTRACTOR Personnel of, and/or hiring by, CONTRACTOR in connection with the Services.

XX. NOTICES

All notices required or permitted to be given under the Agreement shall be in writing, and shall be deemed given when delivered by hand or sent by registered or certified mail, return receipt requested, to the address as follows:

JDPF
JDPF

To: PRDOH

William O. Rodríguez Rodríguez, Esq.
Secretary
Puerto Rico Department of Housing
606 Barbosa Ave.
Juan C. Cordero Dávila Bldg.
San Juan, PR 00918

WORR
WORR

To: CONTRACTOR

José D. Pérez Fernández
Authorized Representative
Caribe Tecno, CRL
P.O. Box 360099
San Juan, PR 00936

XXI. THIRD PARTIES

Nothing contained in this Agreement shall create a contractual relationship with, or a cause of action of a third party against either the PRDOH or the CONTRACTOR.

XXII. SUBCONTRACTS

A. General: All subcontracts shall contain the applicable provisions described in **Attachment F** (HUD General Provisions), as well as applicable provisions set forth in 2 C.F.R. § 200.101. The PRDOH shall review subcontracts as part of the compliance, monitoring, and oversight process performed by PRDOH or upon request.

B. Specific Requirements: All subcontracts shall contain provisions specifying:

- i. That the work performed by the subcontractor be in accordance with the applicable terms of this Agreement between the PRDOH and CONTRACTOR;
- ii. That nothing contained in such subcontract agreement shall impair the rights of the PRDOH;
- iii. That nothing contained herein, or under this Agreement will create any contractual relation between the subcontractor and the PRDOH;
- iv. That the subcontractor specifically agrees to be bound by the confidentiality provision regarding Personal Identifiable Information set forth in this Agreement;
- v. That CONTRACTOR will be responsible for ensuring all subcontract work is performed consistent with federal and state regulations and/or policies to be eligible for reimbursement of the approved work; and

vi. All Federal flow down provisions are included in the subcontract agreement per Federal guidelines.

- C. Monitoring:** CONTRACTOR shall diligently monitor all subcontracted services. If CONTRACTOR discovers any areas of noncompliance, CONTRACTOR shall provide the PRDOH summarized written reports supported with documented evidence of corrective action.
- D. Content:** CONTRACTOR shall cause all the applicable provisions of this Agreement to be included in, and made a part of, any subcontract executed in the performance of this Agreement.
- E. Notification:** CONTRACTOR shall notify and provide a copy of any and all subcontracts related to this Agreement and CDBG-DR and CDBG-MIT funds to the Contract Administration Area of the PRDOH CDBG-DR Legal Division within **three (3) business days** of its execution.

XXIII. CERTIFICATION OF COMPLIANCE WITH LEGAL REQUIREMENTS

Given that the Agreement involves funds for which HUD is the oversight agency, the CONTRACTOR agrees to carry out its obligations under this Agreement in compliance with all the requirements described in **Attachment F** (HUD General Provisions), **Attachment G** (Contractor Certification Requirement) and the following provisions:

- A. Compliance with Executive Order No. OE-2022-014:** The CONTRACTOR agrees to faithfully comply with the provisions of the Executive Order No. OE-2022-014 of February 20, 2022 (OE-2022-014), the Labor Project Agreement¹ signed by the PRDOH and the Contractor (**Attachment H**).

The CONTRACTOR will provide a minimum salary of fifteen dollars (\$15.00) per hour to skilled construction workers and eleven dollars (\$11.00) to un-skilled construction workers, for the work performed within the "Construction Project", as defined in the OE-2022-014.

The CONTRACTOR commits to acquire and use cement produced in Puerto Rico in compliance with Act No. 109 of July 12, 1985 for the completion of the "Construction Project". The CONTRACTOR acknowledges that this is an essential condition of this Agreement whose breach by itself, or by any subcontractor, will release PRDOH from disburse funds for any part or section of the "Construction Project" completed in non-compliance with OE-2022-014. In addition, the CONTRACTOR recognizes that non-compliance with this clause could lead to cancellation, without more, of this Agreement.

The CONTRACTOR shall include in any awarded contract to perform the work on behalf of the PRDOH, a clause in which obligate the subcontractor to comply with all provisions of OE-2022-014 (including the provisions concerning the acquisition of cement produced in Puerto Rico and the minimum compensation for workers who work within the "Construction Project"), the Labor Project Agreement signed between the PRDOH and the Contractor, as well as any other document issued pursuant to OE-2022-014.

¹ The OE 2022-014 implements a pilot program for the incorporation of the Labor Agreements. The Secretary of Labor has to issue a new Labor Agreement in compliance with OE-2022-014. Until such agreement has been issued, the Labor Agreement under Executive Order No. OE-2018-033 remains in effect.

JDPF
JDPF

WORR
WORR

Similarly, the clause to be included by the CONTRACTOR must provide for any subcontractor to include a similar compliance clause in any subcontract that provides for the release of its obligation before the CONTRACTOR.

B. Compliance with Act No. 173. The CONTRACTOR hereby certifies that in signing this Agreement it is in compliance with Act No. 173 of August 12, 1988, as amended, known as the "Board of Examiners of Engineers, Architects, Surveyors, and Landscape Architects of Puerto Rico Act", 20 L.P.R.A. §§ 711-711z to exercise the profession of engineering, architecture, surveying or landscaping architecture in Puerto Rico, is registered in the official Register of the Board, and is an active member of the College of Engineers and Surveyors of Puerto Rico or the College of Architects and Landscape Architects of Puerto Rico, as applicable.

C. Compliance with Executive Order 24: Pursuant to Executive Order 24 of June 18, 1991, the CONTRACTOR certifies and guarantees that at the signing of this Agreement it has filed all the necessary and required income tax returns to the Government of Puerto Rico for the last **five (5) years**. The CONTRACTOR further certifies that it has complied and is current with the payment of any and all income taxes that are, or were due, to the Government of Puerto Rico. The CONTRACTOR shall hand out, to the satisfaction of the PRDOH and whenever requested by the PRDOH during the term of this Agreement, the necessary documentation to support its compliance of this clause. The CONTRACTOR will be given a specific amount of time by the PRDOH to produce said documents. During the term of this Agreement, the CONTRACTOR agrees to pay and/or to remain current with any repayment plan agreed to by the CONTRACTOR with the Government of Puerto Rico.

D. Compliance with Executive Order 52: Pursuant to Executive Order 52 of August 28, 1992, amending EO-1991-24, the CONTRACTOR certifies and warrants that it has made all payments required for unemployment benefits, workmen's compensation and social security for chauffeurs, whichever is applicable, or that in lieu thereof, has subscribed a payment plan in connection with any such unpaid items and is in full compliance with the terms thereof. The CONTRACTOR accepts and acknowledges its responsibility for requiring and obtaining a similar warranty and certification from each and every CONTRACTOR and subcontractor whose service the CONTRACTOR has secured in connection with the services to be rendered under this Agreement and shall forward evidence to PRDOH as to its compliance with this requirement.

E. Social Security and Income Tax Retentions: The CONTRACTOR will be responsible for rendering and paying the Federal Social Security and Income Tax Contributions for any amount owed as a result of the income from this Agreement.

F. Government of Puerto Rico Municipal Tax Collection Center (CRIM, for its Spanish acronym): The CONTRACTOR certifies and guarantees that at the signing of this Agreement it has no current debt with regards to property taxes that may be registered with the Government of Puerto Rico's Municipal Tax Collection Center. The CONTRACTOR further certifies to be current with the payment of any and all property taxes that are or were due to the Government of Puerto Rico. The CONTRACTOR shall hand out, to the satisfaction of the PRDOH and whenever requested by the PRDOH during the term of this Agreement, the necessary documentation to support its compliance of this clause. The CONTRACTOR will deliver upon request any documentation requested under this clause as per request of PRDOH. During the Term of this Agreement, the CONTRACTOR agrees to pay and/or to remain current with

JDPF
JDPF

WRR
WRR

any repayment plan agreed to by the CONTRACTOR with the Government of Puerto Rico with regards to its property taxes.

- G. Income Tax Withholding:** The PRDOH shall retain the corresponding amount from all payments made to the CONTRACTOR, as required by the Puerto Rico Internal Revenue Code. The PRDOH will advance such withholdings to the Government of Puerto Rico's Treasury Department (known in Spanish as *Departamento de Hacienda del Gobierno de Puerto Rico*). The PRDOH will adjust such withholdings provided the CONTRACTOR produces satisfactory evidence of partial or total exemption from withholding.
- H. Compliance with Act No. 45 of April 18, 1935, as amended, 11 L.P.R.A. § 1, et seq.:** The CONTRACTOR certifies and guarantees that at the signing of this Agreement has valid insurance issued by the State Insurance Fund Corporation (CFSE, for its Spanish Acronym), as established by Act No. 45, *supra*, known as the "Puerto Rico Workers' Accident Compensation Act".
- I. Government of Puerto Rico's Agency for the Collection of Child Support (ASUME, for its Spanish acronym):** The CONTRACTOR certifies and guarantees that at the signing of this Agreement that the CONTRACTOR nor any of its Partners, if applicable, have any debt or outstanding debt collection legal procedures with regards to child support payments that may be registered with the Government of Puerto Rico's Child Support Administration. The CONTRACTOR hereby certifies that it is a limited liability company organized and existing in good standing under the laws of the Government of Puerto Rico. The CONTRACTOR shall present, to the satisfaction of PRDOH, the necessary documentation to substantiate the same. The CONTRACTOR will be given a specific amount of time by PRDOH to deliver said documents.
- J. Compliance with Act No. 168-2000, as amended, 8 L.P.R.A. § 711, et seq.:** The CONTRACTOR is in full compliance with Act No. 168-2000, as amended, known as "Act for the Improvement of Elderly Support of Puerto Rico."
- K. Compliance with Act No. 1-2012, as amended, 3 L.P.R.A. § 1854, et seq.:** The PRDOH and the CONTRACTOR hereby certify that in signing this Agreement they are in compliance with Act No. 1-2012, as amended, known as "Puerto Rico Government Ethics Act of 2011", in connection with the possibility of a conflict of interest.
- L. Clause of Governmental Ethics Certification of Absence of Conflict of Interests -** The CONTRACTOR certifies that: (1) No public servant of this executive agency has a pecuniary interest in this contract, purchase or commercial transaction. (2) No public servant of this executive agency has requested me or accepted from me, directly or indirectly, for him (her), for any member of his family unit or for any person, gifts, bonuses, favors, services, donations, loans or anything else of monetary value. (3) No public servant (s) requested or accepted any good of economic value, linked to this transaction, from any person of my entity as payment for performing the duties and responsibilities of their employment. (4) No public servant has requested from me, directly or indirectly, for him (her), for any member of her family unit, or for any other person, business or entity, some of economic value, including gifts, loans, promises, favors or services in exchange for the performance of said public servant is influenced in my favor or of my entity. (5) I have no kinship relationship, within the fourth degree of consanguinity and second by affinity, with any public servant who has the power to influence and participate in the institutional decisions of this executive agency.

JDPF
JDPF

WRR
WRR

M. Ethics. CONTRACTOR also acknowledges receipt and agrees to obey with the Anticorruption Code for the New Puerto Rico known in Spanish as "Código Anticorrupción para el Nuevo Puerto Rico".

N. Non-Conviction. The CONTRACTOR certifies that it has not been convicted nor accused of a felony or misdemeanor against the government, public faith and function, or that involves public property or funds, either federal or local in origin. Furthermore, CONTRACTOR also certifies that:

1. It has not been convicted, nor has pleaded guilty at a state or federal bar, in any jurisdiction of the United States of America, of crimes consisting of fraud, embezzlement or misappropriation of public funds, as stated in Act Number 2 of January 2, 2018, as amended, known as the Anti-Corruption Code for the New Puerto Rico, which prohibits the award of Offers or government contracts to those convicted of fraud, misappropriation of public fund.
2. It understands and accepts that any guilty plea or conviction for any of the crimes specified in Article 3 of said Act, will also result in the immediate cancellation of any contracts in force at the time of conviction, between the undersigned and whichever Government Agencies, Instrumentalities, Public Corporations, Municipalities and the Legislative or Judicial Branches.
3. It declares under oath the above mentioned in conformity with what is established as in Act Number 2 of January 2, 2018, as amended, known as the Anti-Corruption Code for the New Puerto Rico, which prohibits awarding Offers for government contracts, to those convicted of fraud, embezzlement or misappropriation of public funds.
4. The CONTRACTOR represents and guarantees that none of its employees, officials or agents have been convicted of a felony or misdemeanor as described in this sub-section. Moreover, the CONTRACTOR agrees to notify PRDOH should any employee, official, or agent is convicted of a felony or misdemeanor as described in this sub-section after the date of this Agreement. Said notice shall be made within **ten (10) business days** from the time of the conviction.

O. Other payments or compensation: The CONTRACTOR certifies that it does not receive payment or compensation for regular services rendered as an official or public employee to another government entity, agency, public corporation or municipality, and knows the ethical standards of his profession and assumes responsibility for his actions.

P. Consequences of Non-Compliance: The CONTRACTOR expressly agrees that the conditions outlined throughout this Section are essential requirements of this Agreement; thus, should any one of these representations, warrants, and certifications be incorrect, inaccurate or misleading, in whole or in part, there shall be sufficient cause for PRDOH to render this Agreement null and void and the CONTRACTOR reimburse to PRDOH all moneys received under this Agreement.

Q. Non-Conflict of Interest Certification: The CONTRACTOR shall comply with **Attachment K** (Non-Conflict of Interest Certification), attached herein and made an integral part of this Agreement, which outlines several situations that may reasonably be considered as conflicts of interest. The aforementioned certification aids PRDOH, in its

JDPF
JDPF

WRR
WRR

role as grantee, to identify, evaluate, disclose and manage apparent potential, or actual conflicts of interest related to CDBG-DR and CDBG-MIT funded projects, activities, and/or operations.

- R. Compliance with the documentation requirements for contracting with professional services with the Government of Puerto Rico (Act No. 237-2004):** The CONTRACTOR shall submit the required documentation applicable for professional services contracts with the Government of Puerto Rico. PRDOH will execute this Agreement conditioned to the submission of the aforementioned documentation within **thirty (30) days** of the signing of this Agreement. Failure to comply with the submission of the documentation may result in the withholding of reimbursements or the termination of the Agreement.

JDPF
JDPF

XXIV. ACT NO. 18 OF OCTOBER 30, 1975, as amended, 2 L.P.R.A. secs. 97-98

WORR
WORR

The parties to this Agreement agree that its effective date will be subject to the due registration and remittance to the Office of the Comptroller of Puerto Rico. No rendering or consideration subject matter of this Agreement will be required before its registration at the Office of the Comptroller of Puerto Rico pursuant to Act No. 18 of October 30, 1975, as amended. The CONTRACTOR will be responsible for ensuring that this Agreement has been registered before the rendering of services by requesting a copy of the registered Agreement with its proper number and date of registry. No services under this Agreement will continue to be delivered after its effective date unless at the expiration date, an amendment signed by both parties and duly registered exists. No services performed in violation of this provision will be paid. The party violating this clause will be doing so without any legal authority, this action will be deemed as *ultra vires*.

XXV. MEMORANDUM NO. 2021-003; CIRCULAR LETTER 001-2021 OF THE OFFICE OF THE CHIEF OF STAFF OF THE GOVERNOR (SECRETARÍA DE LA GOBERNACIÓN) & THE OFFICE OF MANAGEMENT AND BUDGET (OFICINA DE GERENCIA Y PRESUPUESTO)

- A. Interagency Services Clause:** Both contracting parties acknowledge and agree that services retained may be provided to any entity of the Executive Branch with which the contracting entity makes an interagency agreement or by direct provision of the Office of the Chief of Staff of the Governor (*Secretaría de la Gobernación*). These services will be performed under the same terms and conditions in terms of hours of work and compensation set forth in this Agreement. For purposes of this clause, the term "Executive Branch entity" includes all agencies of the Government of Puerto Rico, as well as public instrumentalities and corporations and the Office of the Governor.
- B. Termination Clause:** The Chief of Staff (*Secretario de la Gobernación*) of the Governor shall have the power to terminate this Agreement at any time.
- C. Contract Review Policy of the Financial Supervision and Administration Board for Puerto Rico:** The parties acknowledge that the contractor has submitted the certification entitled "Contractor Certification Requirement" required in accordance with the Contract Review Policy of the Financial Oversight and Management Board (FOMB) for Puerto Rico, effective as of November 6, 2017 as amended on October 30, 2020, signed by the Contractor's Executive Director (or another official with an equivalent position or authority to issue such certifications). A signed copy of the "Contractor's Certification Requirement" is included as **Attachment G** to this contract.

XXVI. MEMORANDUM NO. 2021-029; CIRCULAR LETTER NO. 013-2021 OF THE OFFICE OF THE CHIEF OF STAFF OF THE GOVERNOR (SECRETARÍA DE LA GOBERNACIÓN) & THE OFFICE OF MANAGEMENT AND BUDGET (OFICINA DE GERENCIA Y PRESUPUESTO):

- A.** The PRDOH certifies that the CONTRACTOR was selected as the provider of the services described in this agreement, pursuant to OE 2021-029.
- B.** The Parties certify that they acknowledge the provisions stated in OE 2021-029 and CC 013-2021. Any failure to comply with the requirements set forth in OE 2021-029 and CC 013-2021 will result in the termination of this agreement.
- C.** The CONTRACTOR certifies that it has informed PRDOH of any current contractual relationship with any government entities of the Government of Puerto Rico. The CONTRACTOR certifies that said entities are all the entities of the Government of Puerto Rico with which they maintain a contractual relationship. In addition, the CONTRACTOR recognizes and accepts that omitting any information regarding any current contractual relationship with any governmental entity could result in the termination of this agreement if so required by PRDOH.
- D.** The CONTRACTOR certifies that it has informed the PRDOH whether or not the entity is a public corporation whose shares are exchanged in a stock exchange properly regulated. In the event that the CONTRACTOR certifies that it is not a public corporation that exchanges shares in a stock change, the CONTRACTOR certifies it has completed the applicable certification as stated in CC-013-2021.

XXVII. FINANCIAL OVERSIGHT AND MANAGEMENT BOARD FOR PUERTO RICO (FOMB) POLICY: REVIEW OF CONTRACTS, AS MODIFIED ON APRIL 30, 2021, REGARDING PROFESSIONAL SERVICES

The FOMB Policy requires that all agreements that contemplate recurring professional services that may be performed by appropriately trained government staff include a provision of compliance with the adequate transfer of skills and technical knowledge to the pertinent public sector personnel. This requirement shall not apply to contracts which contemplate non-recurring professional services or specialized professional services that may not be performed by existing staff at the applicable governmental entity, including as a result of independence requirements.

Accordingly, given that the agreements under CDBG-DR are non-recurring professional services or specialized professional services, the PRDOH certifies that the transfer of skills and technical knowledge required by the Certified Fiscal Plan is inapplicable given the non-recurring or specialized nature of the contracted services.

As mentioned before, HUD allocated funds for disaster recovery assistance to the Government of Puerto Rico under the CDBG-DR Program. These funds are intended to provide financial assistance to address unmet needs that arise and that are not covered by other sources of financial aid. In addition, with these allocations of funding under the Grant Agreement, the PRDOH will conduct a comprehensive recovery to benefit the residents of Puerto Rico.

XXVIII. COMPLIANCE WITH THE FINANCIAL OVERSIGHT AND MANAGEMENT BOARD FOR PUERTO RICO (FOMB) POLICY, REVIEW OF CONTRACTS

As part of the PRDOH contract process, and pursuant to Section 204(b)(2) of the "Puerto Rico Oversight, Management, and Economic Stability Act," 48 U.S.C. §2101, et seq., also

JDPF
JDPF

WORR
WORR

known as "PROMESA", the Financial Oversight and Management Board for Puerto Rico (FOMB) require approval of certain contracts and amendments to assure that they "promote market competition" and "are not inconsistent with the approved fiscal plan." For the approval process, the FOMB requests, among other information, the Contractor Certification Requirement for its evaluation.

In compliance with the above, the CONTRACTOR represents and warrants that the information included in the Contractor Certification Requirement is complete, accurate and correct, and that any misrepresentation, inaccuracy or falseness in such Certification will render the contract null and void and CONTRACTOR will have the obligation to reimburse immediately to the Commonwealth any amounts, payments or benefits received from the Commonwealth under the proposed Amendment and original Agreement.

JDPF
JDPF

WORR
WORR

XXIX. COMPLIANCE WITH FEDERAL LAW, REGULATIONS, & EXECUTIVE ORDERS

The CONTRACTOR acknowledges that HUD financial assistance will be used to fund the Agreement only. Also, the CONTRACTOR shall comply with all applicable Federal, state and local laws, rules, regulations, and policies relating to CDBG-DR and CDBG Program services. This includes without limitation, applicable Federal Registers; 2 C.F.R. part 200 Uniform Administrative Requirements, Cost Principles, and Audit Requirements for Federal Awards; Housing and Community Development Act of 1974; 24 C.F.R. part 570 Community Development Block Grant; applicable waivers; Fair Housing Act, 24 C.F.R. Part 35, 24 C.F.R. Part 58, 24 C.F.R. Part 135; National Historic Preservation Act, and any other applicable state laws or regulations, including the requirements related to nondiscrimination, labor standards, and the environment; and Action Plan amendments and HUD's guidance on the funds. Also, CONTRACTOR shall comply, without limitation, those set forth in **Attachment F** and in compliance with all the requirements described in **Attachment G**.

XXX. FEDERAL LAWS AND REGULATIONS APPLICABLE TO CONSTRUCTION CONTRACTS

A. COPELAND "ANTI-KICKBACK" ACT

Salaries of personnel performing work under this Agreement shall be paid unconditionally and not less often than once a month without payroll deduction or rebate on any account except only such payroll deductions as are mandatory by law or permitted by the applicable regulations issued by the Secretary of Labor pursuant to the Copeland "Anti-Kickback Act" of June 13, 1934 (48 Stat. 948; 62 Stat. 740; 63 Stat. 108; Title 18 U.S.C. § 874; and Title 40 U.S.C. § 276c).

The CONTRACTOR, as well as any subcontractors, shall provide a weekly statement with respect to the wages paid to each of its employees engaged on work covered by the Copeland "Anti-Kickback Act" during the preceding weekly payroll period.² The CONTRACTOR, as well as any subcontractors, shall deliver each weekly statement within seven days after the regular payment date of the payroll period, to the PRDOH. After such examination and check as may be made, such statement, or a copy thereof, shall be kept available, or shall be transmitted together with a report of any violation, in accordance with applicable procedures prescribed by the U.S. Department of Labor. The CONTRACTOR shall preserve his weekly payroll records for a period of 6 years from date of completion of this Agreement and also the Subrecipients must comply with the

² This statement shall be executed by the contractor or by an authorized officer or employee of the contractor who supervises the payment of wages, and shall be on the back of Form WH 347, "Payroll (For Contractors Optional Use)" or on any form with identical wording. Copies of WH 347 may be obtained from the Government contracting or sponsoring agency or from the Wage and Hour Division Web site at <http://www.dol.gov/whd/forms/index.htm> or its successor site.

record retention requirements, as established in the policy on document handling, administration and accessibility, in accordance with the RKMA policy, and ensure that all documentations is always available for any internal or external tracing visit. Such payroll records shall be made available at all times for inspection by the contracting officer or his authorized representative, and by authorized representatives of the Department of Labor.

The CONTRACTOR, as well as any subcontractors, shall comply with all applicable "Anti-Kickback" regulations and shall insert HUD form 4010 and any additional provisions in all subcontracts covering work under this Agreement to ensure compliance by subcontractors with such regulations as applicable, and shall be responsible for the submission of affidavits and Statements of Compliance required of subcontractors thereunder except as the Secretary of Labor may specifically provide for variations of or exemptions from the requirements thereof.³

JDPF
JDPF

WDRR
WDRR

B. CONTRACT WORK HOURS AND SAFETY STANDARDS ACT

The CONTRACTOR, as well as any subcontractors, shall comply with Sections 103 and 107 of the Contract Work Hours and Safety Standards Act (CWHSSA) (40 U.S.C. §§ 33701-3708) as supplemented by Department of Labor regulations (29 C.F.R. Part 5). Where applicable, all contracts awarded by the non-Federal entity in excess of \$100,000 that involve the employment of mechanics or labors. The provisions of CWHSSA apply to all labors and mechanic, including watchmen and guards. 40 U.S.C. Section 3701(b)(2).

The CONTRACTOR, as well as any subcontractors, agrees to compute the wages of every mechanic and laborer on the basis of a standard work week of forty (40) hours in accordance with and subject to the provisions of the CWHSSA. Any work in excess of the standard work week is permissible provided that the worker is compensated at a rate of no less that on and a half times the basic rate of pay for all hours worked in excess of forty (40) hours in the work week. The CONTRACTOR will not require any laborer or mechanic employed in the performance of this Agreement to work in surroundings or under working conditions that are unsanitary, hazardous, or dangerous to health or safety, as established under construction safety and health standards.

The CONTRACTOR, as well as any subcontractors, shall insert appropriate provisions of the CWHSSA in all subcontracts covering work under this Agreement to ensure compliance by subcontractors with such regulations, and shall be responsible for the submission of affidavits required of subcontractors thereunder except as the Secretary of Labor may specifically provide for variations of or exemptions from the requirements thereof.

The CONTRACTOR, as well as any subcontractors, shall comply with all regulations issued pursuant to that act and with other applicable Federal laws and regulations pertaining to labor standards.⁴

C. DAVIS-BACON ACT

The CONTRACTOR, as well as any subcontractors, shall comply with the Davis Bacon Act (40 U.S.C. §§ 3141-3148) as supplemented by the Department of Labor regulations (29 C.F.R. Part 5).

All laborers and mechanics employed by the CONTRACTOR, as well as any subcontractors, including employees of other governments, on construction, work assisted under this Agreement, and subject to the provisions of the federal acts and regulations listed in this paragraph, shall be paid wages at rates not less than those

³ <https://www.dol.gov/agencies/whd/government-contracts/copeland-anti-kickback>

⁴ <https://www.dol.gov/agencies/whd/government-contracts/cwhssa>

prevailing on similar construction in the locality as determined by the Secretary of Labor in accordance with the Davis-Bacon Act. The advertised specifications for every contract in excess of \$2,000, for construction, alteration, or repair, including painting and decorating, of public buildings and public works. 40 U.S.C. Sec. 3142.⁵

The CONTRACTOR, as well as any subcontractors, shall pay all mechanics and laborers employed directly on the site of the work, unconditionally and at least once a week, and without subsequent deduction or rebate on any account, the full amounts accrued at time of payment, computed at wage rates not less than those stated in the advertised specifications, regardless of any contractual relationship which may be alleged to exist between the contractor or subcontractor and the laborers and mechanics. The CONTRACTOR will post the scale of wages to be paid in a prominent and easily accessible place at the site of the work.

There may be withheld from the CONTRACTOR so much of accrued payments as the contracting officer considers necessary to pay to laborers and mechanics employed by the contractor or any subcontractor on the work the difference between the rates of wages required by the contract to be paid laborers and mechanics on the work and the rates of wages received by the laborers and mechanics and not refunded to the contractor or subcontractors or their agents.

On a semi-annual basis, the CONTRACTOR shall submit Form HUD 4710 (Semi-Annual labor Standards Enforcement Report) to PRDOH. All covered subcontracts must include Davis-Bacon and other labor standards clauses and the applicable federal wage determinations as well as the local prevailing wage established in this contract. The Federal Labor Standards Provisions on Form HUD 4010 covers the Davis-Bacon and related acts expected in all subcontracts covering work under this Agreement to ensure compliance by subcontractors with such regulations, and shall be responsible for the submission of affidavits required of subcontractors thereunder except as the Secretary of Labor may specifically provide for variations of or exemptions from the requirements thereof.

The HUD Form 4010 and a Spanish translation of the original form is included as **Attachment I** to this contract. The attachment ensures contractors, with a predominant fluency in Spanish, are able to immediately reference labor requirements to ensure full compliance for Davis-Bacon and related Acts.

In addition, the applicable wage determination is included as **Attachment J** to this contract. The attachment guarantees that the contractors are informed of the prevailing wages to ensure compliance with federal and state regulations.

D. FAIR LABOR STANDARDS ACT OF 1938, AS AMENDED

The CONTRACTOR, as well as any subcontractors, shall comply with the provisions of the Fair Labor Standards Act (29 U.S.C. §§ 201-219), which governs such matters as Federal minimum wage rates and overtime, as supplemented by the Department of Labor regulations (29 C.F.R. Parts 500-899).

The CONTRACTOR agrees to comply and implement the applicable regulations of the U.S. Department of Labor at 29 C.F.R. Parts 500-899.⁶

XXXI. CDBG-DR POLICIES AND PROCEDURES

In addition to what is established in this Agreement, the CONTRACTOR shall comply with all CDBG-DR and CDBG-MIT program specific and general policies and procedures,

⁵ Section 110 of the Act, determines the DBRA applicability to CDBG-DR. The Act further provides that Section 5310 (Section 110 of the Act) apply to the rehabilitation of residential property only if such property contains not less than eight (8) units. (8 units or more)

⁶ <https://www.dol.gov/agencies/whd/flsa>

JDPF
JDPF

WORR
WORR

including, but not limited to, the Contract and Subrecipient Agreement Manual, OS&H Guideline, MWBE Policy, Procurement Manual for the CDBG-DR Program , URA & ADP Guidelines, Cross Cutting Guidelines, AFWAM Policy, Section 3 Policy, Personally Identifiable Information, Confidentiality, and Nondisclosure Policy and Conflict of Interest and Standards of Conduct Policy, as found in the CDBG-DR Website (www.cdbg-dr.pr.gov), which are herein included and made integral part of this Agreement, as they may be updated from time to time, and reporting requirements as established by the PRDOH.

XXXII. SECTION 3 CLAUSE

A. The work to be performed under this contract is subject to the requirements of Section 3 of the Housing and Urban Development Act of 1968, as amended, 12 U.S.C. 1701u (Section 3). The purpose of Section 3 is to ensure that employment and other economic opportunities generated by HUD assistance or HUD-assisted projects covered by Section 3, shall, to the greatest extent feasible, be directed to low- and very low-income persons, particularly persons who are recipients of HUD assistance for housing.

B. The parties to this contract agree to comply with HUD's regulations in 24 C.F.R. part 75, which implement Section 3. As evidenced by their execution of this contract, the parties to this contract certify that they are under no contractual or other impediments that would prevent them from complying with the part 75 regulations.

C. The contractor agrees to send to each labor organization or representative of workers with which the contractor has a collective bargaining agreement or other understanding, if any, a notice advising the labor organization or workers' representative of the contractor's commitments under this Section 3 clause, and will post copies of the notice in conspicuous places at the work site where both employees and applicants for training and employment positions can see the notice. The notice shall describe the Section 3 preference, shall set forth minimum number and job titles subject to hire, availability of apprenticeship and training positions, the qualifications for each; the name and location of the person(s) taking applications for each of the positions; and the anticipated date the work shall begin.

D. The contractor agrees to include this Section 3 clause in every subcontract subject to compliance with regulations in 24 C.F.R. part 75 and agrees to take appropriate action, as provided in an applicable provision of the subcontract or in this Section 3 clause, upon a finding that the subcontractor is in violation of the regulations in 24 C.F.R. part 75. The contractor will not subcontract with any subcontractor where the contractor has notice or knowledge that the subcontractor has been found in violation of the regulations in 24 C.F.R. part 75.

E. The contractor acknowledges that subrecipients, contractors, and subcontractors are required to meet the employment, training, and contraction requirements of 24 CFR 75.19, regardless of whether Section 3 language is included in recipient or subrecipient agreements, program regulatory agreements, or contracts.

F. The contractor will certify that any vacant employment positions, including training positions, that are filled (1) after the contractor is selected but before the contract is executed, and (2) with persons other than those to whom the regulations of 24 C.F.R. part 75 require employment opportunities to be directed, were not filled to circumvent the contractor's obligations under 24 C.F.R. part 75.

JDPF
JDPF

WORR
WORR

G. Noncompliance with HUD's regulations in 24 C.F.R. part 75 may result in sanctions, termination of this contract for default, and debarment or suspension from future HUD-assisted contracts.

H. With respect to work performed in connection with Section 3 covered Indian housing assistance, section 7(b) of the Indian Self-Determination and Education Assistance Act (46 U.S.C. § 5307) also applies to the work to be performed under this contract. Section 7(b) requires that to the greatest extent feasible (i) preference and opportunities for training and employment shall be given to Indians, and (ii) preference in the award of contracts and subcontracts shall be given to Indian organizations and Indian-owned Economic Enterprises. Parties to this contract that are subject to the provisions of Section 3 and section 7(b) agree to comply with Section 3 to the maximum extent feasible, but not in derogation of compliance with section 7(b).

JDPF
JDPF

WRR
WRR

- I.** The Contractor agrees to submit, and shall require its subcontractors to submit to them, quarterly reports to the PRDOH detailing the total number of labor hours worked on the Section 3 Project, the total number of labor hours worked by Section 3 Workers, and the total number of hours worked by Targeted Section 3 Workers, and any affirmative efforts made during the quarter to direct hiring efforts to low- and very low-income persons, particularly persons who are Section 3 Workers and Targeted Section 3 Workers.

XXXIII. BYRD ANTI-LOBBYING AMENDMENT, 31 U.S.C. § 1352

The CONTRACTOR certifies, to the best of his or her knowledge, that:

- A.** -No Federal appropriated funds have been paid or will be paid, by or on behalf of the undersigned, to any person for influencing or attempting to influence an officer or employee of an agency, a Member of Congress, an officer or employee of Congress, or an employee of a Member of Congress in connection with the awarding of any Federal contract, the making of any Federal grant, the making of any Federal loan, the entering into of any cooperative agreement, and the extension, continuation, renewal, amendment, or modification of any Federal contract, grant, loan, or cooperative agreement.
- B.** --If any funds other than Federal appropriated funds have been paid or will be paid to any person for influencing or attempting to influence an officer or employee of any agency, a Member of Congress, an officer or employee of Congress, or an employee of a Member of Congress in connection with this Federal contract, grant, loan, or cooperative agreement, the undersigned shall complete and submit Standard Forms-LLL, "Disclosure Form to Report Lobbying," in accordance with its instructions.
- C.** -The CONTRACTOR shall require that the language of this certification be included in the award documents for all subawards at all tiers (including subcontracts, subgrants, and contracts under grants, loans, and cooperative agreements) and that all sub recipients shall certify and disclose accordingly. This certification is a material representation of fact upon which reliance was placed when this transaction was made or entered into. Submission of this certification is a prerequisite for making or entering into this transaction imposed by 31, U.S.C. § 1352 (as amended by the Lobbying Disclosure Act of 1995). The CONTRACTOR acknowledges that any person who fails to file the required certification shall be

subject to a civil penalty of not less than \$10,000 and not more than \$100,000 for each such failure. The CONTRACTOR certifies or affirms the truthfulness and accuracy of each statement of its certification and disclosure, if any. In addition, the CONTRACTOR understands and agrees that the provisions of 31 U.S.C. §3801 *et seq.*, apply to this certification and disclosure, if any.

XXXIV.EQUAL OPPORTUNITY

- A. -The CONTRACTOR will not discriminate against any employee or applicant for employment because of race, color, religion, sex, sexual orientation, gender identity or national origin. The CONTRACTOR will take affirmative action to ensure that applicants are employed, and that employees are treated during employment without regard to their race, color, religion, sex, or national origin. Such action shall include, but not be limited to the following: Employment, upgrading, demotion, or transfer; recruitment or recruitment advertising; layoff or termination; rates of pay or other forms of compensation; and selection for training, including apprenticeship. The CONTRACTOR agrees to post in conspicuous places, available to employees and applicants for employment, notices to be provided setting forth the provisions of this nondiscrimination clause.
- B. --The CONTRACTOR will, in all solicitations or advertisements for employees placed by or on behalf of the CONTRACTOR, state that all qualified applicants will receive considerations for employment without regard to race, color, religion, sex, or national origin.
- C. -When applicable, the CONTRACTOR will send to each labor union or representative of workers with which he has a collective bargaining agreement or other contract or understanding, a notice to be provided advising the said labor union or workers' representatives of the CONTRACTOR's commitments under this Section and shall post copies of the notice in conspicuous places available to employees and applicants for employment.
- D. -The CONTRACTOR will comply with all provisions of Executive Order 11246 of September 24, 1965, as amended by Executive Order 11375 of October 13, 1967, and as supplemented by the rules, regulations, and relevant orders of the United States Secretary of Labor.
- E. --The CONTRACTOR will furnish all information and reports required by Executive Order 11246 of September 24, 1965, as amended, and by rules, regulations, and orders of the Secretary of Labor, or pursuant thereto, and will permit access to his books, records, and accounts by the administering agency and the Secretary of Labor for purposes of investigation to ascertain compliance with such rules, regulations, and orders.
- F. --In the event of the CONTRACTOR's noncompliance with the nondiscrimination clauses of this Agreement or with any of the said rules, regulations, or orders, this Agreement may be canceled, terminated, or suspended in whole or in part and the CONTRACTOR may be declared ineligible for further Government contracts or federally assisted construction contracts in accordance with procedures authorized in Executive Order 11246 of September 24, 1965, as amended, and such other sanctions as may be imposed and remedies invoked as provided in Executive Order 11246 of September 24, 1965, as amended, or by rule, regulation, or order of the Secretary of Labor, or as otherwise provided by law.

JDPF
JDPF

WORR
WORR

G.-The CONTRACTOR will include the portion of the sentence immediately preceding paragraph (A) and the provisions of paragraphs (A) through (F) in every subcontract or purchase order unless exempted by rules, regulations, or orders of the Secretary of Labor issued pursuant to Section 204 of Executive Order 11246 of September 24, 1965, as amended, so that such provisions will be binding upon each subcontractor or vendor. The CONTRACTOR will take such action with respect to any subcontract or purchase order as the administering agency may direct as a means of enforcing such provisions, including sanctions for noncompliance. Provided, however, that in the event a CONTRACTOR becomes involved in, or is threatened with, litigation with a subcontractor or vendor as a result of such direction by the administering agency, the CONTRACTOR may request the United States to enter into such litigation to protect the interests of the United States.

JDPF
JDPF

WORR
WORR

XXXV. SOLID WASTE DISPOSAL ACT

1) In the performance of this contract, the CONTRACTOR shall make maximum use of products containing recovered materials that are Environmental Protection Agency (EPA)- designated items unless the product cannot be acquired:

- a. Competitively within a timeframe providing for compliance with the contract performance schedule;
- b. Meeting contract performance requirements; or
- c. At a reasonable price.

2) Information about this requirement, along with the list of EPA- designated items, is available at EPA's Comprehensive Procurement Guidelines web site, <https://www.epa.gov/smm/comprehensive-procurement-guideline-cpg-program>.

e

3) Contractor must comply with section 6002 of the Solid Waste Disposal Act, as amended by the Resource Conservation and Recovery Act. The requirements of Section 6002 include:

- a. procuring only items designated in guidelines of the EPA at 40 C.F.R. part 247 that contain the highest percentage of recovered materials practicable, consistent with maintaining a satisfactory level of competition, where the purchase price of the item exceeds ten thousand dollars (\$10,000) or the value of the quantity acquired during the preceding fiscal year exceeded ten thousand dollars (\$10,000);
- b. procuring solid waste management services in a manner that maximizes energy and resource recovery; and
- c. establishing an affirmative procurement program for procurement of recovered materials identified in the EPA guidelines.

XXXVI. DRUG FREE WORKPLACE

The CONTRACTOR should establish procedures and policies to promote a Drug-Free workplace. Further, the CONTRACTOR should notify all employees of its policy for maintaining a Drug-Free workplace, and the penalties that may be imposed for drug abuse violations occurring in the workplace. Further, the CONTRACTOR shall notify the PRDOH if any of its employees is convicted of a criminal drug offense in the workplace no later than **ten (10) days** after such conviction.

XXXVII.SUSPENSION AND DEBARMENT

- A. -This Agreement is a covered transaction for purposes of 2 C.F.R. part 180 and 2 C.F.R. part 2424. As such, the CONTRACTOR is required to verify that none of the CONTRACTOR, its principals (defined at 2 C.F.R. § 180.995), or its affiliates (defined at 2 C.F.R. §180.905) are excluded (defined at 2 C.F.R. §180.940) or disqualified (defined at 2 C.F.R. §180.935).
- B.--The CONTRACTOR must comply with 2 C.F.R. part 180, subpart C and 2 C.F.R. part 2424, and must include a requirement to comply with these regulations in any lower tier covered transaction it enters into.
- C. -This certification is a material representation of fact relied upon by PRDOH. If it is later determined that the CONTRACTOR did not comply with 2 C.F.R. part 180, subpart C and 2 C.F.R. part 2424, in addition to remedies available to PRDOH, the Federal Government may pursue available remedies, including but not limited to suspension and/or debarment.
- D. -The CONTRACTOR agrees to comply with the requirements of 2 C.F.R. part 180, subpart C and 2 C.F.R. part 2424, while this Agreement is valid. The CONTRACTOR further agrees to include a provision requiring such compliance in its lower tier covered transactions.

JDPF
JDPF

WORR
WORR

XXXVIII. SYSTEM FOR AWARD MANAGEMENT (SAM) REGISTRATION

The CONTRACTOR must be registered in the System for Award Management (SAM) and shall maintain its registration active during contract performance and through final payment. The CONTRACTOR is responsible during performance and through final payment for the accuracy and completeness of the data within SAM. Failure to maintain registration in SAM can impact obligations and payments under this Agreement.

XXXIX. NO OBLIGATION BY THE FEDERAL GOVERNMENT

The Federal Government is not a party to this Agreement and is not subject to any obligations or liabilities to the non-Federal entity, CONTRACTOR, or any other party pertaining to any matter resulting from the Agreement.

XLI. PROGRAM FRAUD & FALSE OR FRAUDULENT STATEMENTS OR RELATED ACTS

The CONTRACTOR acknowledges that 31 U.S.C. Chapter 38 (Administrative Remedies for False Claims and Statements) applies to the CONTRACTOR's actions pertaining to this Agreement.

XLI. BANKRUPTCY

In the event that CONTRACTOR files for bankruptcy protection, the Government of Puerto Rico and PRDOH may deem this Agreement null and void, and terminate this Agreement without notice.

XLII. ENTIRE AGREEMENT

This Agreement and all its attachments represent the entire and integrated agreement between PRDOH and the CONTRACTOR and supersede all prior negotiations,

representations, agreements and/or understandings of any kind. This Agreement may be amended only by written document signed by both PRDOH and the CONTRACTOR.

XLIII. MODIFICATION OF AGREEMENT

Any modification of this Agreement or additional obligation assumed by either party in connection with this Agreement shall be binding only if written and signed by both parties, and its authorized representatives. Those amendments shall make specific reference to this Agreement, comply with programmatic policies, procedures, and guidelines. Such amendments shall not invalidate this Agreement, nor relieve or release the Parties from their obligations under this Agreement.

However, PRDOH reserves the right to notify in writing to CONTRACTOR any applicable policies, procedures, regulations, requirements, guidelines, or change in law, whether existing or to be established, as well as changes and/or amendments thereof, and the notified policies, procedures, regulations, requirements, guidelines and laws shall be deemed incorporated by reference to this Agreement without the need of executing a separate written and signed amendment.

XLIV. BINDING EFFECT

This Agreement shall be binding upon and shall inure to the benefit of PRDOH and the CONTRACTOR, their successors and assigns.

The CONTRACTOR shall not assign this Agreement, in whole or in part, without the prior written consent of PRDOH, and any attempted assignment not in accordance herewith shall be null and void and of no force or effect.

XLV. ASSIGNMENT OF RIGHTS

The rights of each party hereunder are personal to that party and may not be assigned or otherwise transferred to any other person, contractor, corporation, or other entity without the prior, express, and written consent of the other party.

XLVI. NON-WAIVER

The failure or delay of either party to insist upon the performance of and/or the compliance with any of the terms and conditions of this Agreement shall not be construed as a waiver of such terms and conditions or the right to enforce compliance with such terms and conditions.

XLVII. ORDER OF PRECEDENCE

In the event of an inconsistency in this Agreement or if a conflict occurs between this Agreement and any Attachment, Appendix, Exhibit, or Schedule, unless otherwise specifically stated in those documents, the order of precedence shall be: Federal laws, regulations, and policies applicable to this Agreement, this Contract and the HUD General Provisions (Attachment F), the Scope of Work (Attachment B), the Cost Form (Attachment C), and lastly, the CONTRACTOR's proposal (Attachment A).

JDPF
JDPF

WRR
WRR

XLVIII. GOVERNING LAW JURISDICTION

This Agreement shall be governed by, interpreted, and enforced in accordance with the laws of the Government of Puerto Rico and any applicable federal laws and regulations. The parties further agree to assert any claims or causes of action that may arise out of this Agreement in the Puerto Rico Court of First Instance, Superior Court of San Juan, Puerto Rico.

XLIX. CONSOLIDATIONS, MERGERS, CHANGE OF NAME, OR DISSOLUTIONS

A. Consolidation or Merger

In the event that the signing party (e.g. Subrecipient, Contractor, or Subcontractor) of the Agreement with the PRDOH moves for a consolidation or merger with another entity (private or public), by its discretion or otherwise, written notice of such decision or event shall be delivered to the PRDOH **at least fifteen (15) business days prior to the effective date** of the consolidation or merger. The notice shall include, but not limited to, a description of: the expected effective date of the consolidation or merger; name of each of the constituent entities moving to consolidate or merge into the single resulting or surviving entity; the proposed name of the resulting entity (in case of a consolidation) or the name of the surviving entity (in case of a merger) if necessary; reference to the projected capacity of the resulting or surviving entity to comply with the terms, conditions, obligations, tasks, services, and performance goals or requirements included in the Agreement as well as its Exhibits or Attachments; and a brief summary of the proposed plan to achieve the transition of duties (Scope of Work), tasks, and performance goals or requirements to the resulting or surviving entity.

Upon the consolidation or the merger becoming effective, and supporting evidence of such event is notified to PRDOH, execution of an Amendment to the Agreement may follow. The Amendment would include, but not limited to, modifications to the clauses that refer to the identity, personal circumstances, address, and any other information related to the signing party deemed relevant by PRDOH for the execution of the Amendment. **No amendment to the Agreement will be necessary if the Subrecipient, Contractor, or Subcontractor becomes the surviving entity following a merger.**

Failure to comply with any of the before mentioned conditions, may result in the activation of the termination clauses provided in the Agreement.

B. Change of Name

In the event that the signing party (e.g. Subrecipient, Contractor, or Subcontractor) of the Agreement with the PRDOH initiates a change of name process, written notice of such decision or event shall be delivered to the PRDOH **at least fifteen (15) business days** prior to the effective date of such event. The notice shall include, but not limited to, a description of: the expected effective date of the change of name; the proposed name; inform of any change of address; and reference of any change in the capacity of the entity to comply with the terms, conditions, obligations, tasks, services, and performance goals or requirements included in the Agreement, as well as its Exhibits or Attachments.

Upon the change of name becoming effective, and supporting evidence of such event is notified to PRDOH, execution of an Amendment to the Agreement may follow. The Amendment would include, but not limited to, modifications to the clauses that refer to the identity, personal circumstances, address, and any other information related to the signing party deemed relevant by PRDOH for the execution of the Amendment.

Failure to comply with any of the before mentioned conditions, may result in the activation of the termination clauses provided in the Agreement.

C. Dissolution

In the event that the signing party (e.g. Subrecipient, Contractor, or Subcontractor) of the Agreement with the PRDOH moves for dissolution of the entity, written notice of such decision or event shall be delivered to the PRDOH **at least fifteen (15) business days** prior to the effective date of such event. The notice shall include, but not limited to, a

JDPF
JDPF

WORR
WORR

description of the expected effective date of the dissolution; and contact information of one or more of its directors, officials or agents. Upon dissolution, becoming effective, and supporting evidence of such event is notified to PRDOH, termination of the Agreement will follow. Consequently, the signing party acknowledges and agrees to provide to the PRDOH, after termination of the Agreement, the assistance reasonably requested to facilitate the orderly transfer of responsibility for performance of the tasks or services to the PRDOH or a third party designated by the PRDOH. Moreover, all finished or unfinished records (files, data, work product) connected with this Agreement will be turned over to PRDOH following the Agreement termination.

L. HEADINGS

The titles to the paragraphs of this Agreement are solely for reference purposes and the convenience of the parties and shall not be used to explain, modify, simplify, or aid in the interpretation of the provisions of this Agreement.

JDPF
JDPF

WORR
WORR

LI. FEDERAL FUNDING

The fulfillment of this Agreement is based on those funds being made available to the PRDOH as the lead administrative agency for Recovery. All expenditures under this Agreement must be made in accordance with this Agreement, the policies and procedures promulgated under the CDBG-DR and CDBG-MIT Program, and any other applicable laws. Further, CONTRACTOR acknowledges that all funds are subject to recapture and repayment for non-compliance.

LII. RECAPTURE OF FUNDS

PRDOH may recapture payments it makes to CONTRACTOR that (i) exceed the maximum allowable rates; (ii) are not allowed under applicable laws, rules, or regulations; or (iii) are otherwise inconsistent with this Agreement, including any unapproved expenditures. CONTRACTOR must refund such recaptured payments within **thirty (30) business days** after the PRDOH issues notice of recapture to CONTRACTOR.

LIII. OVERPAYMENT

CONTRACTOR shall be liable to the PRDOH for any costs disallowed pursuant to financial and/or compliance audit(s) of funds received under this Agreement. CONTRACTOR shall reimburse such disallowed costs from funds other than those CONTRACTOR received under this Agreement.

LIV. SEVERABILITY

If any provision of this Agreement shall operate or would prospectively operate to invalidate the Agreement in whole or in part, then such provision only shall be deemed severed and the remainder of the Agreement shall remain operative and in full effect.

LV. COUNTERPARTS

This Agreement may be executed in any number of counterparts, each of whom shall be deemed to be an original, however, all of which together shall constitute one and the same instrument. If the Agreement is not executed by the PRDOH within **thirty (30) calendar days** of execution by the other party, this Agreement shall be null and void.

LVI.SURVIVAL OF TERMS AND CONDITIONS

The terms and conditions of this Agreement related to the following subjects shall survive the termination or expiration of this Agreement: interpretive provisions; consideration; warranties; general affirmations, federal assurances, federal and state certifications; CDBG-DR, CDBG-MIT and state funding, recapture of CDBG-DR, CDBG-MIT and/or state funds, overpayment of CDBG-DR, CDBG-MIT and/or state funds; ownership and intellectual property, copyright; records retention methods and time requirements; inspection, monitoring and audit; confidentiality; public records; indemnification and liability; infringement of intellectual property rights; independent contractor relationship; compliance with laws; notices; choice of law and venue; severability; dispute resolution; consolidations, merger, change of name, and dissolution. Terms and conditions that, explicitly or by their nature, evidence the Parties' intent that they should survive the termination or expiration of this Agreement shall so survive.

JDPF
JDPF

WORR
WORR

IN WITNESS THEREOF, the parties hereto execute this Agreement in the place and on the date first above written.

PUERTO RICO DEPARTMENT OF HOUSING

CARIBE TECNO, CRL

William O. Rodríguez Rodríguez

William O. Rodríguez Rodríguez (Dec 19, 2022 16:31 AST)

William O. Rodríguez Rodríguez, Esq.
Secretary

José D. Pérez Fernández

José D. Pérez Fernández (Dec 15, 2022 18:32 AST)

José D. Pérez Fernández
Authorized Representative

Attachment A

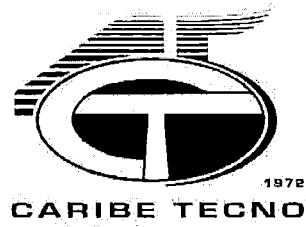

**PV Systems, Water Storage System Acquisition and Installation Services Community Development
Block Grant – Disaster Recovery/Mitigation Puerto Rico Department of Housing**

CDBG-DR-IFB-2022-03

JDPF
JDPF

WORR
WORR

Photovoltaic Panels



Preliminary Technical Information Sheet

CanadianSolar

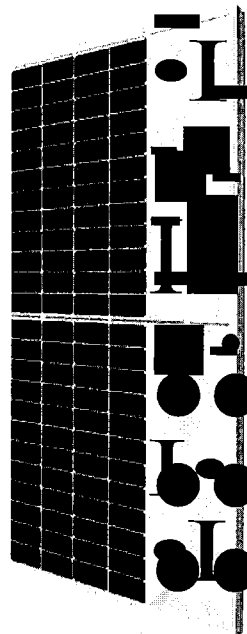

HiKu

SUPER HIGH POWER MONO PERC MODULE

425W~450W

CS3W-425 | 430 | 435 | 440 | 445 | 450MS

JDPF
JDPF

WORR
WORR

MORE POWER



26 % more power than conventional modules



Up to 4.5 % lower LCOE
Up to 2.7 % lower system cost



Low NMOT: 42 ± 3 cc
Low temperature coefficient (Pmax):
-0.36 % / cc



Better shading tolerance

MORE RELIABLE



Lower internal current,
lower hot spot temperature



Cell crack risk limited in small region,
enhance the module reliability



Heavy snow load up to 5400 Pa,
wind load up to 3600 Pa*



linear power output warranty*



enhanced product warranty on materials
and workmanship*

*According to the applicable Canadian Solar Limited Warranty Statement.

MANAGEMENT SYSTEM CERTIFICATES*

ISO 9001 :2015 / Quality management system
ISO 14001 :2015 / Standards for environmental management system
OHSAS 18001 :2007 / International standards for occupational health & safety

PRODUCT CERTIFICATES*

IEC 61215 / IEC 61730: VDE / CE (Expected in December, 2019)

* As there are different certification requirements in different markets, please contact your local Canadian Solar sales representative for the specific certificates applicable to the products in the region in which the products are to be used.

CANADIAN SOLAR INC. is committed to providing high quality solar products, solar system solutions and services to customers around the world. No. 1 module supplier for quality and performance/price ratio in IHS Module Customer Insight Survey. As a leading PV project developer and manufacturer of solar modules with over 36 GW deployed around the world since 2001.

* For detail information, please refer to Installation Manual.

CANADIAN SOLAR INC.

545 Speedvale Avenue West, Guelph, Ontario N1K 1E6, Canada, www.canadiansolar.com, support@canadiansolar.com

ENGINEERING DRAWING (mm)

Rear View

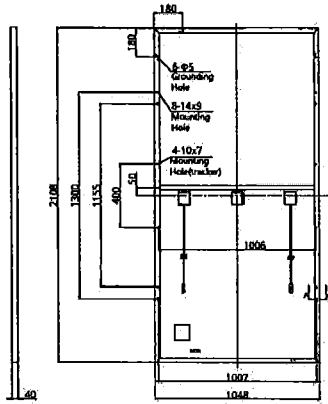

Frame Cross Section A-A

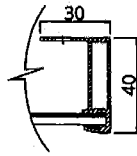

Mounting Hole

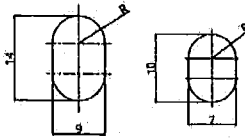

CS3W-435MS / I-V CURVES

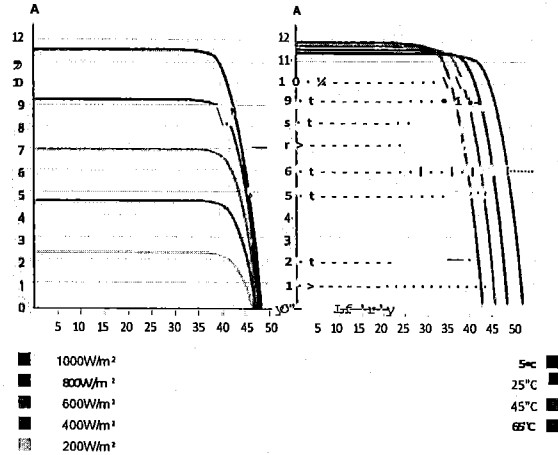

ELECTRICAL DATA I STC*

CS3W	425MS	430MS	435MS	440MS	445MS	450MS
Nominal Max. Power (Pmax)	425 W	430 W	435 W	440 W	445 W	450 W
Opt. Operating Voltage (Vmp)	39.5 V	39.7 V	39.9 V	40.1 V	40.3 V	40.5 V
Opt. Operating Current (Imp)	10.76 A	10.84 A	10.91 A	10.98 A	11.05 A	11.12 A
OpenCircuitVoltage(Voc)	47.7V	47.9V	48.1V	48.3V	48.5V	48.7V
Short Circuit Current (Isc)	11.37 A	11.42 A	11.47 A	11.53 A	11.59 A	11.65 A
Module Efficiency	19.24%	19.46%	19.69%	19.92%	20.14%	20.37%
Operating Temperature	-40° C - +85° C					
Max. System Voltage	1500V (IEC/UL) or 1000V (IEC/UL)					
Module Fire Performance	TYPE 1 (UL 1703) or CLASS C (IEC 61730)					
Max. Series Fuse Rating	20A					
Application Classification	Class A					
Power Tolerance	0 - + 5 W					

* Under Standard Test Conditions (STC) of Irradiance of 1000 W/m², spectrum AM 1.5 and cell temperature of 25°C.

ELECTRICAL DATA I NMOT*

CS3W	425MS	430MS	435MS	440MS	445MS	450MS
Nominal Max. Power (Pmax)	316W	320W	324W	328W	331 W	335W
Opt. Operating Voltage (Vmp)	36.8 V	36.9V	37.1 V	37.3V	37.5V	37.7V
Opt. Operating Current (Imp)	8.60 A	8.67 A	8.73A	8.79A	8.84A	8.89A
Open Circuit Voltage (Voc)	44.7V	44.9V	45.1 V	45.3 V	45.5V	45.6V
Short Circuit Current (Isc)	9.17 A	9.21 A	9.25A	9.30A	9.35A	9.40A

* Under Nominal Module Operating Temperature (NMOT), Irradiance of 800 W/m² spectrum AM 1.5, ambient temperature 20°C, wind speed 1 m/s.

MECHANICAL DATA

Specification	Data
Cell Type	Mono-crystalline
Cell Arrangement	144 [2 X (12 X 6)]
Dimensions	2108 X1048 X40 mm (83.0 X41.3 X1.57 in)
Weight	24.9 kg (54.9 lbs)
Front Cover	3.2 mm tempered glass
Frame	Anodized aluminium alloy, crossbar enhanced
J-Box	IP68, 3 bypass diodes
Cable	4 mm² (IEC), 12 AWG (UL)
Cable Length (Including Connector)	Portrait: 500 mm (19.7 in)(+/-) 350 mm (13.8 in)(-); landscape: 1400 mm (55.1 in); leap-frog connection: 1670 mm (65.7 in)*
Connector	T4 series or H4 UTX or MC4-EVO2
Per Pallet	27 pieces
Per Container (40' HQ)	594 pieces

* For detailed information, please contact your local Canadian Solar sales and technical representatives.

TEMPERATURE CHARACTERISTICS

Specification	Data
Temperature Coefficient (Pmax)	-0.36 % / °C
Temperature Coefficient (Voc)	-0.29 % / °C
Temperature Coefficient (Isc)	0.05 % / °C
Nominal Module Operating Temperature	42 ± 3° C

PARTNER SECTION

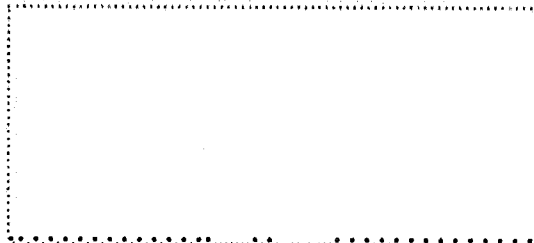

* The specifications and key features contained in this datasheet may deviate slightly from our actual products due to the on-going Innovation and product enhancement. Canadian Solar Inc. reserves the right to make necessary adjustment to the information described herein at any time without further notice.

Please be kindly advised that PV modules should be handled and installed by qualified people who have professional skills and please carefully read the safety and installation instructions before using our PV modules.

CANADIAN SOLAR INC.

545 Speedvale Avenue West, Guelph, Ontario N1 K 1E6, Canada, www.canadiansolar.com, support@canadiansolar.com

JDPF
JDPF

WORR
WORR



Certificación de Equipos de Energía Renovable

Datos de la Solicitud

De acuerdo a la información suministrada se solicita la certificación para equipo(s) de energía renovable Comercial-Privado en territorio del Estado Libre Asociado de Puerto Rico, según indicado(s) a continuación:

Solicitante: RICARDO R ACEVEDO

Correo Electronico: racevedo@glenninternational.com

Compania: Glenn International, Inc.

Datos de Equipo Certificado

Tipo de Equipo(s): Modulo Fotovoltaico

Clasificación: Equipo Existente

MARCA	MODELO	CERTIFICACIONES	ESPECIFICACIONES
CANADIAN SOLAR	CS3W-450MS	Certificación de Potencia: IEC 61215 Num. Certificación: 40045991 Laboratorio: VOE Certificación de Seguridad: UL 1703 Num. Certificación: 2284121 Laboratorio: CSA	Potencia Nominal: 450Watts 10 años (Potencia): 93.05% 20 años (Potencia): 87.55% Dimensiones: 6.92ft x 3.44FT Garantía Manufactura: 12 año(s)
JDPF JDPF CANADIAN SOLAR	CS3W-435MS	Certificación de Potencia: IEC 61215 Num. Certificación: 40045991 Laboratorio: VOE Certificación de Seguridad: UL 1703 Num. Certificación: 2284121 Laboratorio: CSA	Potencia Nominal: 435Watts 10 años (Potencia): 93.05% 20 años (Potencia): 87.55% Dimensiones: 6.92ft x 3.44FT Garantía Manufactura: 12 año(s)
WORR WORR CANADIAN SOLAR	CS3W-430MS	Certificación de Potencia: IEC 61215 Num. Certificación: 40045991 Laboratorio: VOE Certificación de Seguridad: UL 1703 Num. Certificación: 2284121 Laboratorio: CSA	Potencia Nominal: 430Watts 10 años (Potencia): 93.05% 20 años (Potencia): 87.55% Dimensiones: 6.92ft x 3.44FT Garantía Manufactura: 12 año(s)
CANADIAN SOLAR	CS3W-455MS	Certificación de Potencia: IEC 61215 Num. Certificación: 40045991 Laboratorio: VOE Certificación de Seguridad: UL 1703 Num. Certificación: 2284121 Laboratorio: CSA	Potencia Nominal: 455Watts 10 años (Potencia): 93.05% 20 años (Potencia): 87.55% Dimensiones: 6.92ft x 3.44FT Garantía Manufactura: 12 año(s)
CANADIAN SOLAR	CS3W-440MS	Certificación de Potencia: IEC 61215 Num. Certificación: 40045991 Laboratorio: VOE Certificación de Seguridad: UL 1703 Num. Certificación: 2284121 Laboratorio: CSA	Potencia Nominal: 440Watts 10 años (Potencia): 93.05% 20 años (Potencia): 87.55% Dimensiones: 6.92ft x 3.44FT Garantía Manufactura: 12 año(s)
CANADIAN SOLAR	CS3W-445MS	Certificación de Potencia: IEC 61215 Num. Certificación: 40045991 Laboratorio: VOE Certificación de Seguridad: UL 1703 Num. Certificación: 2284121 Laboratorio: CSA	Potencia Nominal: 445Watts 10 años (Potencia): 93.05% 20 años (Potencia): 87.55% Dimensiones: 6.92ft x 3.44FT Garantía Manufactura: 12 año(s)

Division de Edificabilidad

Se recomienda la instalación del equipo de fuente de energía renovable sometido ante la OGPe, a tenor con el Reglamento para la Certificación de Sistemas de Energía Renovable y el Reglamento Conjunto para Obras de Construcción y Usos de Terrenos, vigentes.

Condiciones Especiales

Bajo ninguna circunstancia, deberá interpretar que esta certificación implique la aprobación de instalación de equipos en un proyecto de construcción, ni que se autorice iniciar obras de construcción de clase alguna, sin el tramite del correspondientes permiso de construcción.

Firmas / Sellos

Fecha de Expedición:



SOLAR MODULE
375 W

IREX

Member of SolarBK

72 CELLS-MONOCRYSTALLINE

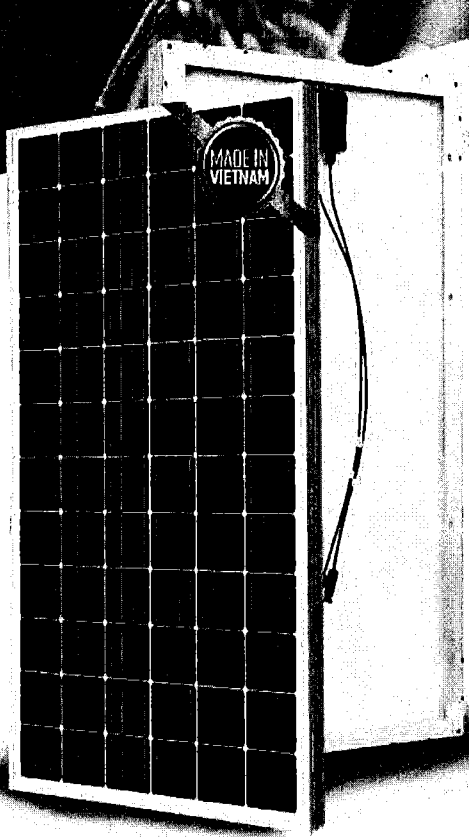

JDPF
JDPF

WORR
WORR



ADVANCED PERC CELL TECHNOLOGY

Absorbing more light, High module efficiency
Low breakage rate, Annual power degradation 0.7%



FAST & SAFE

Easy Installation and handling
Environmentally friendly



MODULE DURABILITY

5400 Pa snow load, 2400 Pa wind load
Ideal for PV rooftops, ground mount, floating



THE #1 DOMESTIC PV MANUFACTURER IN VIETNAM

100% Automatic production line
International quality PV technology

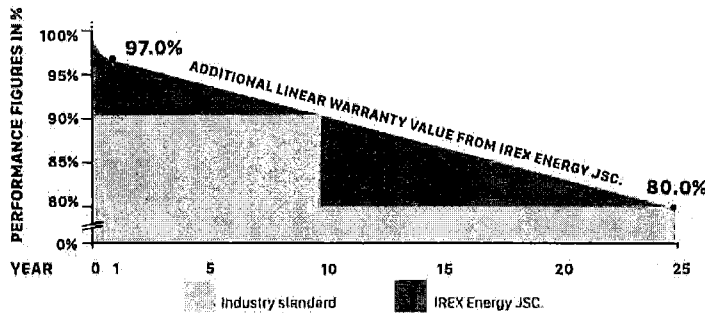

Munich RE

12 - years
Material & workmanship

25 - years
Linear power output

CERTIFICATES



ISO 14001:2015
Environmental Management System

IEC 61216: Terrestrial photovoltaic (PV) modules – Design qualification and type approval
IEC 61730: Photovoltaic (PV) module safety qualification
UL 1703, ULC/ORD-C1703:2018: Standard for Flat-Plate Photovoltaic Modules and Panels
JEG 61701: Salt mist corrosion testing of PV Modules
IEQ 62710: Photovoltaic modules – Ammonia corrosion testing
ISO 9001:2015: Quality Management System
ISO 14001:2015: Environmental Management System

HIGH QUALITY FOR PROSPERITY

IREX Energy Joint Stock Company produces the #1 Vietnamese-Made Photovoltaic (PV) modules, internationally certified with excellent performance and flexible in customization per demand.

Going solar requires a long term commitment. For this, all our solar modules are insured by MunichRE, world's best reinsurance provider. You can sit back, relax and enjoy the sunshining, as our company and warranty partner will always be with you in 25 years!

With the finest price and customer service, you can only be found at IREX Joint Stock Company, we look forward to working with you soon!

IREX ENERGY JOINT STOCK COMPANY

Head Office: No. 47 Le Van Hinh Street, Thanh Xa Ward, Binh Thuan District, Binh Duong, Vietnam
Factory Address: Road No. 1A, Kim My Industrial Zone, Tan Phuoc Ward, Phu My Thuan, Binh Duong - Hung Tay Province, Vietnam
Tel: +84 24 3300 1259 | Email: info@irex.vn | Website: www.irex.vn
Fax HCMC: +84 98 2469 4760 | Fax IREX Factory: +84 291 3923 694



PERFORMANCE

Electrical Performance at 25°C, AM 1.5

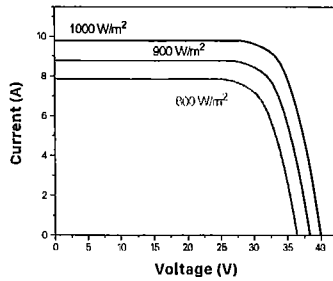

Temperature Dependence of Isc, Voc & Pmax at 1000 W/m², AM 1.5

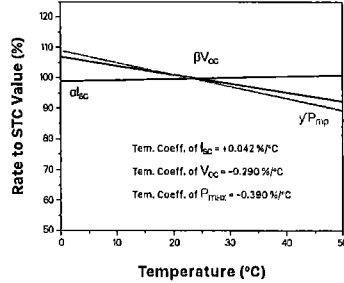

JDPF
JDPF

WORR
WORR

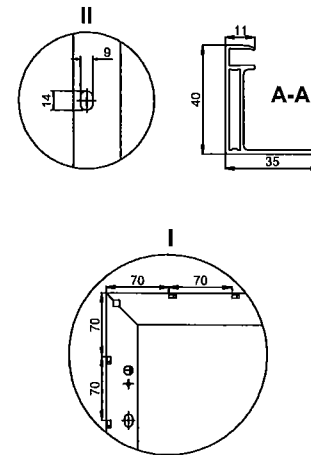
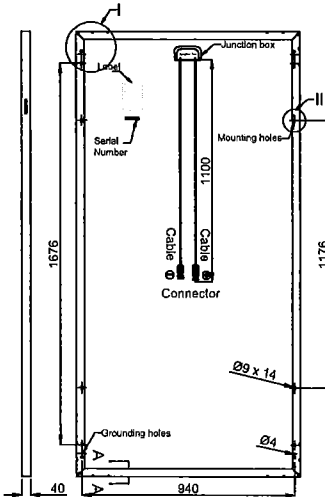
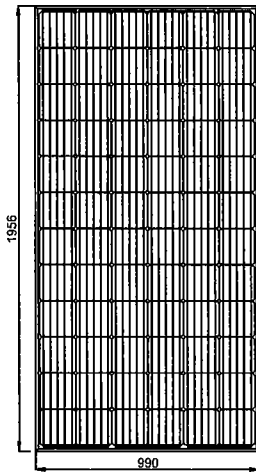

Drawing Only for Reference

ELECTRICAL CHARACTERISTICS STC

IRM72S-375

Maximum Power (Pmax)	375 W
Power Tolerance	0 ~ 3 %
Module Efficiency	19.37 %
Maximum Power Current (Imp)	9.48 A
Maximum Power Voltage (Vmp)	39.56 V
Short Circuit Current (Isc)	10.03 A
Open Circuit Voltage (Voc)	48.68 V
Module Fire Performance	Type 1 (UL 1703) or Class C (IEC 61730)
Values at Standard Test Conditions (STC: AM 1.5 Spectrum, Irradiance of 1000 W/m², Cell Temperature 25 C)	

ELECTRICAL CHARACTERISTICS NMOT

IRM72S-375

Maximum Power (Pmax)	274 W
Maximum Power Current (Imp)	7.50 A
Maximum Power Voltage (Vmp)	36.53 V
Short Circuit Current (Isc)	8.03 A
Open Circuit Voltage (Voc)	45.14 V
Values at Nominal Module Operating Temperature (NMOT: AM 1.5 Spectrum, Irradiance of 800 W/m², Ambient Temperature 20 C, Wind Speed 1 m/s)	

MECHANICAL CHARACTERISTICS

Cell Type	156.75 x 156.75 mm Monocrystalline, 72 (6 x 12) pcs in series
Front Cover	3.2 mm High Transmission, Low Iron, Tempered Glass with Anti-Reflective Coating
Back Cover	Composite film
Frame	Anodized Aluminum Alloy type 6063 - T5 (Silver/ Black)
Junction Box	3 bypass diodes, IP 68 rated in accordance with IEC 62790
Dimension	1956 x 990 x 40 mm
Output Cable	4 mm² (IEC)/ 12 AWG (UL), 1100 mm in accordance with IEC 62852
Weight	22 kg (approx)
Connector	MC4 Compatible

PACKING INFORMATION

Container	20' GP	40' GP	40' HQ
Pallets per Container	10	24	24
Pieces per Container	270	648	696

OPERATING CONDITIONS

Operating Temperature	-40°C ~ +85°C
Maximum System Voltage	1500 VDC (IEC)/ 1500 VDC (UL)
Maximum Series Fuse Rating	20 A (IEC)/ 20 A (UL)
NMOT	45°C ± 2°C
Application Class	Class A

SIII SERIES

Multiple upgrades were forged into one



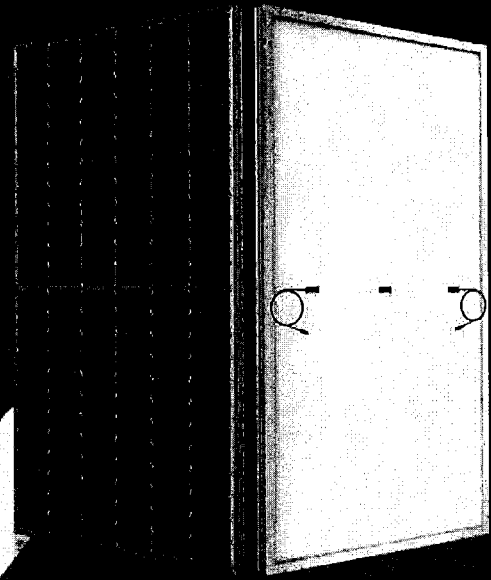



435-450w



• SIII SERIES

Seraphim Energy Group (SEG) redefined the high-efficiency module series by integrating 166mm silicon wafers with multi-busbar and half-cut cell technologies. SEG panel combined creative technology effectively and extremely improved the module efficiency and power output.

• KEY FEATURES

-  Less mismatch to get more power
-  Less power loss by minimizing the shading impact
-  Competitive low light performance
-  3 times EL test to ensure best quality
-  Ideal choice for utility and commercial scale projects by reduced BOS and improve ROI
-  Outstanding reliability proven by PVEL for stringent environment condition :
 - Sand, acid, salt, and hail stones
 - 2400pa wind load and 5400pa snow load
 - Anti-PID

• QUALITY SYSTEM

ISO19001 / ISO14001 / OHSAS18001

• PRODUCT CERTIFICATION



• INSURANCE

PICC

• WARRANTY

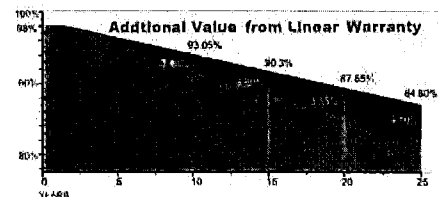

15 YEARS Guarantee on product material and workmanship

25 YEARS linear power output warranty



SERAPHIM ENERGY GROUP (SEG)

Texas office: 873 Isom Road San Antonio, TX 78216
California office: 6200 Stoneridge Mall Rd, Ste 300, Pleasanton, CA 94588
Phone: (925) 468-4108 Web: www.seraphim-energy.us

Electrical Characteristics

Module Type	SEG-435-BMA-HV		SEG-440-BMA-HV		SEG-445-BMA-HV		SEG-450-BMA-HV	
	STC	NOCT	STC	NOCT	STC	NOCT	STC	NOCT
Maximum Power at STC (Pmp)	435	324	440	328	445	332	450	336
Open Circuit Voltage (Voc)	49.6	45.3	49.7	45.4	49.9	45.6	50.1	45.8
Short Circuit Current (Isc)	11.18	9.02	11.27	9.10	11.34	9.17	11.41	9.24
Maximum Power Voltage (Vmp)	41.3	38.2	41.4	38.3	41.6	38.5	41.8	38.7
Maximum Power Current (Imp)	10.54	8.49	10.63	8.57	10.70	8.63	10.77	8.69
Module Efficiency at STC(η_m)	20.01		20.24		20.47		20.70	
Power Tolerance	(0, +3%)							
Maximum System Voltage	1500V DC							
Maximum Series Fuse Rating	20 A							

STC: Irradiance 1000 W/m² module temperature 25°C AM=1.5
Power measurement tolerance: +/-3%

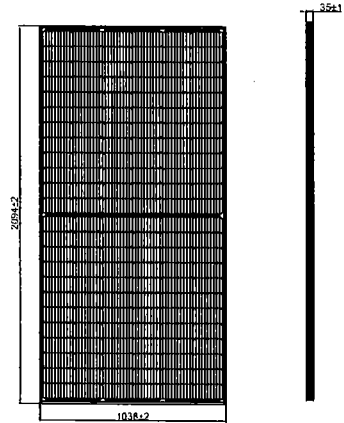

JDPF
JDPF

Temperature Characteristics

Pmax Temperature Coefficient	-0.35 %/°C
Voc Temperature Coefficient	-0.27 %/°C
Isc Temperature Coefficient	+0.05 %/°C
Operating Temperature	-40 ~ +85 °C
Nominal Operating Cell Temperature (NOCT)	45 ± 2 °C

WORR
WORR

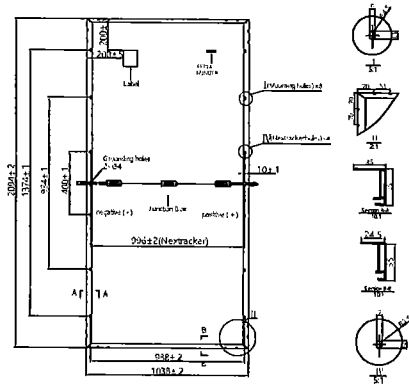

Mechanical Specifications

External Dimensions	2094x 1038 x 35 mm
Weight	23.5 kg
Solar Cells	PERC Mono 166 x 83mm (144 pcs)
Front Glass	3.2 mm AR coating tempered glass, low iron
Frame	Anodized aluminum alloy
Junction Box	IP68, 3 diodes
Output Cables	4.0 mm ² , 250mm(+)/350mm(-) or Customized Length
Mechanical Load	Front side 5400Pa / Rear side 2400Pa

I-V Curve

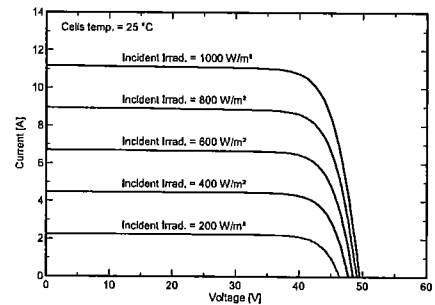

Packing Configuration

	2094 x 1038 x 35 mm	
Container	20'GP	40'HQ
Pieces per Pallet	31	31
Pallets per Container	5	22
Pieces per Container	155	682

For details, please consult SEG.

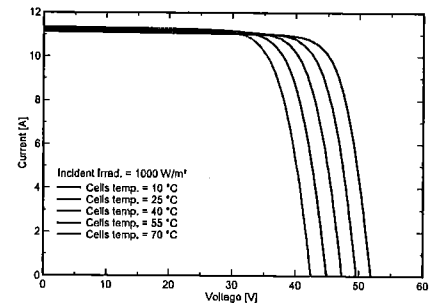

Harvest the Sunshine

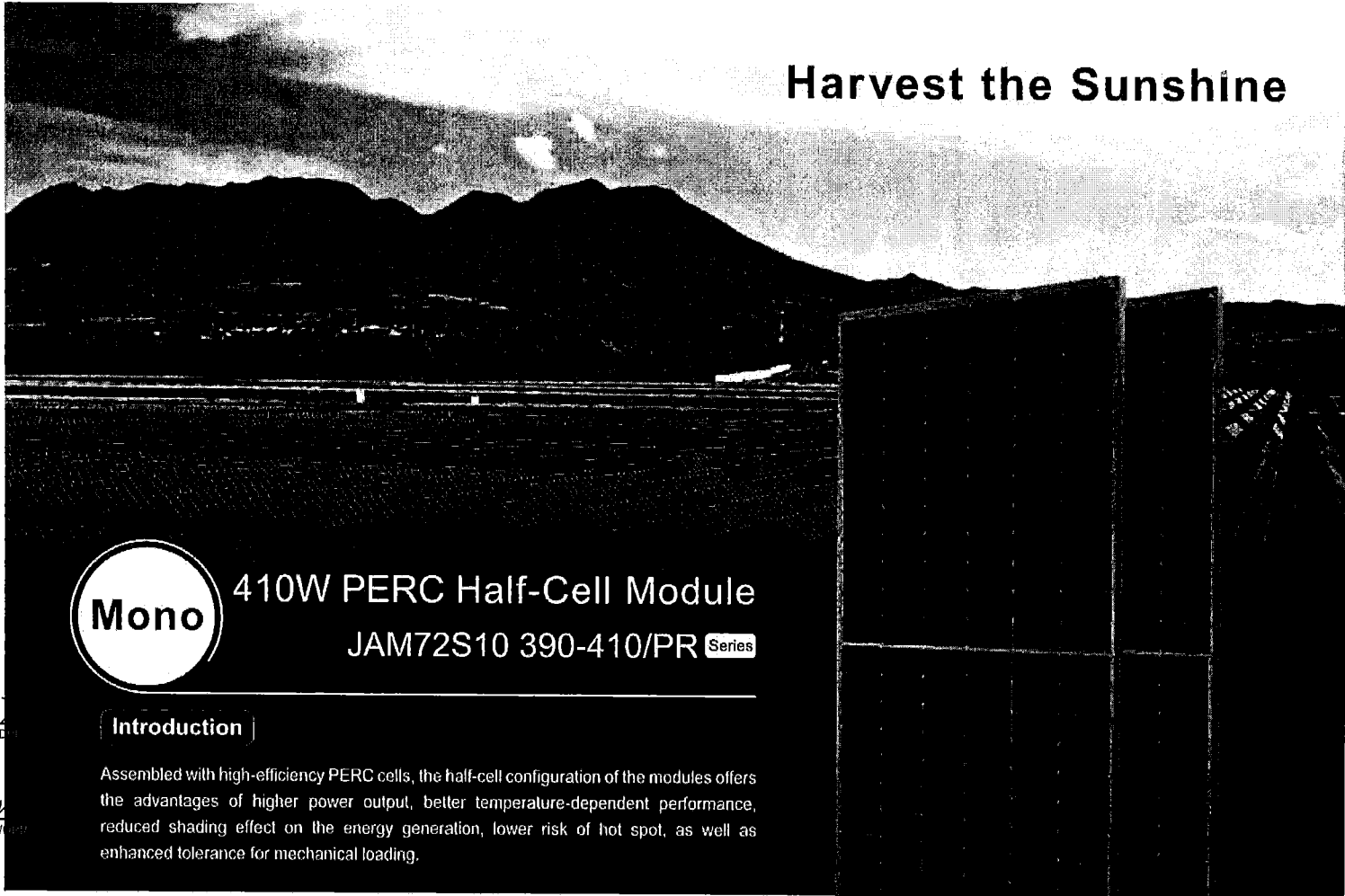

410W PERC Half-Cell Module

JAM72S10 390-410/PR Series

Introduction

Assembled with high-efficiency PERC cells, the half-cell configuration of the modules offers the advantages of higher power output, better temperature-dependent performance, reduced shading effect on the energy generation, lower risk of hot spot, as well as enhanced tolerance for mechanical loading.



Higher output power



Lower temperature coefficient



Less shading effect



Better mechanical loading tolerance

Superior Warranty

- 12-year product warranty
- * 25-year linear power output warranty

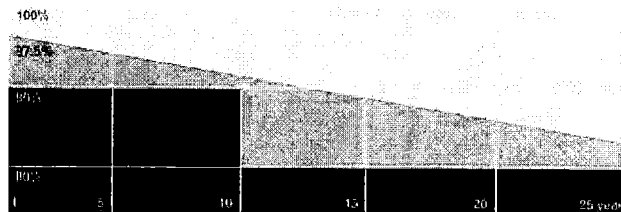

■ JA Linear Power Warranty ■ Industry Warranty

Comprehensive Certificates

- IEC 61215, IEC 61730
- ISO 9001: 2015 Quality management systems
- ISO 14001: 2015 Environmental management systems
- OHSAS 18001: 2007 Occupational health and safety management systems
- IEC TS 62941: 2016 Terrestrial photovoltaic (PV) modules – Guidelines for increased confidence in PV module design qualification and type approval



JASOLAR

www.jasolar.com

Specifications subject to technical changes and tests.
JA Solar reserves the right of final interpretation.



MECHANICAL DIAGRAMS

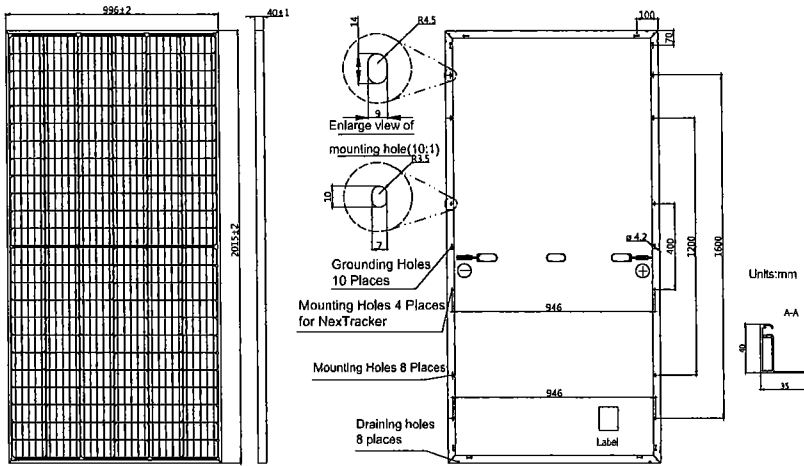

Remark: customized frame color and cable length available upon request

SPECIFICATIONS

Cell	Mono
Weight	22.7kg±3%
Dimensions	2015±2mm×996±2mm×40±1mm
Cable Cross Section Size	4mm ²
No. of cells	144 (6×24)
Junction Box	IP68, 3 diodes
Connector	QC 4, 10-35
Cable Length (Including Connector)	Portrait:300mm(+)/400mm(-); Landscape:1200mm(+)/1200mm(-)
Packaging Configuration	27 Per Pallet

ELECTRICAL PARAMETERS AT STC

JDPF
JDPF

WORR
WORR

TYPE	JAM72S10 -390/PR	JAM72S10 -395/PR	JAM72S10 -400/PR	JAM72S10 -405/PR	JAM72S10 -410/PR
Rated Maximum Power(Pmax) [W]	390	395	400	405	410
Open Circuit Voltage(Voc) [V]	48.91	49.21	49.50	49.81	50.12
Maximum Power Voltage(Vmp) [V]	40.55	40.85	41.17	41.46	41.76
Short Circuit Current(Isc) [A]	10.16	10.21	10.26	10.32	10.37
Maximum Power Current(Imp) [A]	9.62	9.67	9.72	9.77	9.82
Module Efficiency [%]	19.4	19.7	19.9	20.2	20.4
Power Tolerance			0~+5W		
Temperature Coefficient of Isc(α _{Isc})			+0.051%/°C		
Temperature Coefficient of Voc(β _{Voc})			-0.289%/°C		
Temperature Coefficient of Pmax(γ _{Pmp})			-0.350%/°C		

STC

Irradiance 1000W/m², cell temperature 25°C, AM1.5G

Remark: Electrical data in this catalog do not refer to a single module and they are not part of the offer. They only serve for comparison among different module types.
*For NexTracker installations static loading performance: front load measures 2400Pa, while back load measures 2400Pa.

ELECTRICAL PARAMETERS AT NOCT

TYPE	JAM72S10 -390/PR	JAM72S10 -395/PR	JAM72S10 -400/PR	JAM72S10 -405/PR	JAM72S10 -410/PR
Rated Max Power(Pmax) [W]	289	292	296	300	303
Open Circuit Voltage(Voc) [V]	45.04	45.30	45.56	45.81	46.06
Max Power Voltage(Vmp) [V]	37.29	37.52	37.76	38.03	38.28
Short Circuit Current(Isc) [A]	8.18	8.23	8.28	8.33	8.38
Max Power Current(Imp) [A]	7.74	7.79	7.84	7.88	7.93

NOCT

Irradiance 800W/m², ambient temperature 20°C,
wind speed 1m/s, AM1.5G

OPERATING CONDITIONS

Maximum System Voltage	1000V/1500V DC(IEC)
Operating Temperature	-40°C~+85°C
Maximum Series Fuse	20A
Maximum Static Load,Front*	5400Pa
Maximum Static Load,Back*	2400Pa
NOCT	45±2°C
Application Class	Class A

CHARACTERISTICS

Current-Voltage Curve JAM72S10-400/PR

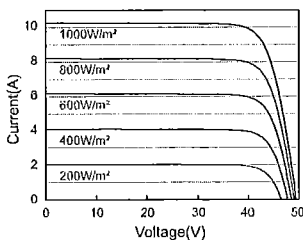

Power-Voltage Curve JAM72S10-400/PR

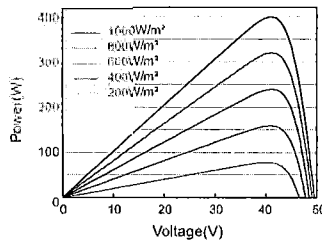

Current-Voltage Curve JAM72S10-400/PR

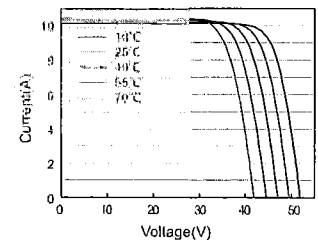

ZXM7-SHLDD120 Series



ZNSHINESOLAR

Znshinesolar 10BB HALF-CELL Bifacial Light-Weight Double Glass Monocrystalline PERC PV Module

435W | 440W | 445W | 450W | 455W | 460W



Excellent cells efficiency

MBB technology decreases the distance between busbar and finger grid line which is benefit to power increase.



Better Weak Illumination Response

More power output in weak light condition, such as haze, cloudy, and early morning.

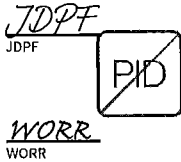

Anti PID

Ensured PID resistance through the quality control of cell manufacturing process and raw materials.



Adapt To Harsh Outdoor Environment

Resistant to harsh environments such as salt, ammonia, sand, high temperature and high humidity environment.



TIER 1

Global, Tier 1 bankable brand, with independently certified state-of-the-art automated manufacturing.



Excellent Quality Management System

Warranted reliability and stringent quality assurances well beyond certified requirements.



Bifacial Technology

Up to 25% additional power gain from back side depending on albedo.

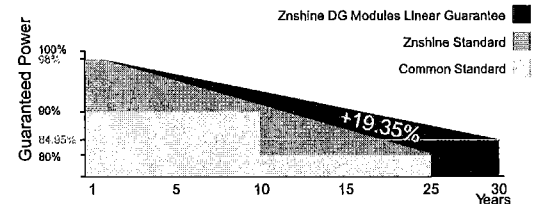
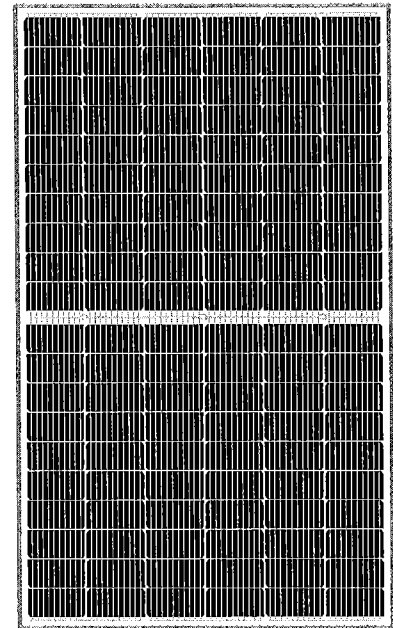

12 years product guarantee
30 years output guarantee



0.45% annual degradation
after the first year



IEC61215/IEC61730/IEC61701/IEC62716/UL61730

ISO 9001: Quality Management System

ISO 14001: Environmental Management System

ISO45001: Occupational Health and Safety Management System

Founded in 1988, ZNShine solar is a world's leading high-tech PV module manufacturer. With the state-of-the-art production lines, the company boasts module capacity of 6GW. Bloomberg has listed ZNShine as a global Tier 1 PV module maker. Today Znshine has distributed its sales to more than 60 countries around the globe.

ELECTRICAL CHARACTERISTICS | STC*

Nominal Power Watt Pmax(W)*	435	440	445	450	455	460
Power Output Tolerance Pmax(%)	0~+3	0~+3	0~+3	0~+3	0~+3	0~+3
Maximum Power Voltage Vmp(V)	34.00	34.20	34.40	34.60	34.80	35.00
Maximum Power Current Imp(A)	12.80	12.87	12.94	13.01	13.08	13.15
Open Circuit Voltage Voc(V)	40.90	41.10	41.30	41.50	41.70	41.90
Short Circuit Current Isc(A)	13.55	13.62	13.69	13.76	13.83	13.90
Module Efficiency (%)	20.04	20.27	20.50	20.73	20.96	21.19

*STC (Standard Test Condition): Irradiance 1000W/m², Module Temperature 25°C, AM 1.5
*Measuring tolerance: ±3%

ELECTRICAL CHARACTERISTICS | NMOT*

Maximum Power Pmax(Wp)	325.30	328.80	332.60	336.30	340.10	343.80
Maximum Power Voltage Vmpp(V)	31.60	31.80	32.00	32.10	32.30	32.50
Maximum Power Current Impp(A)	10.29	10.34	10.40	10.46	10.52	10.58
Open Circuit Voltage Voc(V)	38.20	38.40	38.60	38.80	39.00	39.10
Short Circuit Current Isc(A)	10.94	11.00	11.06	11.11	11.17	11.23

*NMOT(Nominal module operating temperature):Irradiance 800W/m², Ambient Temperature 20°C, AM 1.5, Wind Speed 1m/s

ELECTRICAL CHARACTERISTICS WITH 25% REAR SIDE POWER GAIN

Front power Pmax/W	435	440	445	450	455	460
Total power Pmax/W	544	550	556	563	569	575
Vmp/V(Total)	34.10	34.30	34.50	34.70	34.90	35.10
Imp/A(Total)	15.95	16.03	16.12	16.21	16.30	16.38
Voc/V(Total)	41.00	41.20	41.40	41.60	41.80	42.00
Isc/A(Total)	16.88	16.97	17.06	17.14	17.23	17.32

JDPF
JDPF

WOPR
WOPR

MECHANICAL DATA

Solar cells	Mono PERC
Cells orientation	120 (6×20)
Module dimension	1914×1134×30 mm(With Frame)
Weight	28.5 kg
Glass	2.0 mm+2.0mm, High Transmission, AR Coated Heat Strengthened Glass
Junction box	IP 68, 3 diodes
Cables	4 mm ² , 350 mm
Connectors	MC4-compatible

TEMPERATURE RATINGS WORKING CONDITIONS

NMOT	44°C ±2°C	Maximum system voltage	1500 V DC
Temperature coefficient of Pmax	-0.35%/°C	Operating temperature	-40°C~+85°C
Temperature coefficient of Voc	-0.29%/°C	Maximum series fuse	30 A
Temperature coefficient of Isc	0.05%/°C	Maximum load(snow/wind)	5400 Pa / 2400 Pa

Refer. Bifacial Factor 70±5%
*Do not connect Fuse In Combiner Box with two or more strings in parallel connection
*Remark: Electrical data in this catalog do not refer to a single module and they are not part of the offer. They only serve for comparison among different module types.

PACKAGING CONFIGURATION

Piece/Box	36
Piece/Container(40HQ)	864
Piece/Container(with additional small package)	912

*Please be kindly advised that PV modules should be handled and installed by qualified people who have professional skills and please carefully read the safety and installation instructions before using our PV modules.

DIMENSIONS(MM)

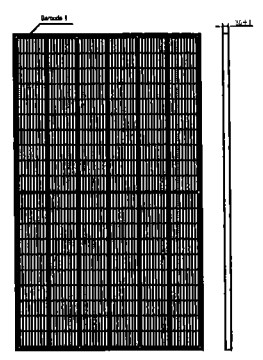

Front View

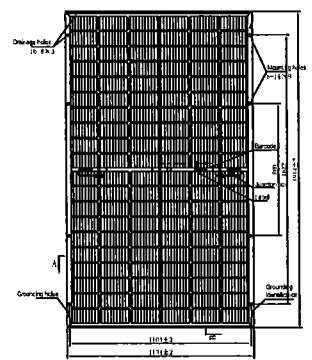

Back View

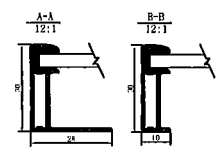

I-V CURVES OF PV MODULE(440W)

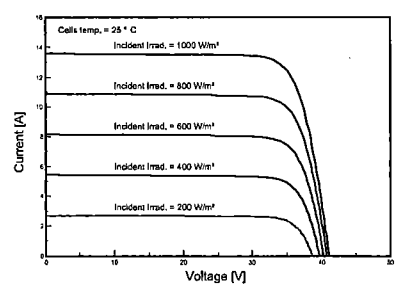

P-V CURVES OF PV MODULE(440W)

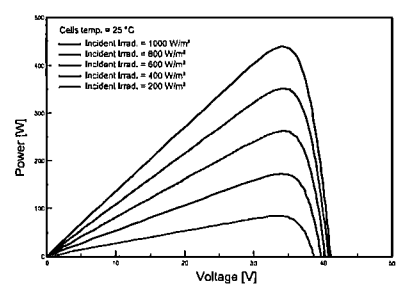



Sol-Ark

5K-P

Spec Sheet



Battery (optional) Output Power 5000W	
Type	Lead-Acid or Li-Ion
Nominal DC Input	48V
Capacity	50 — 9900Ah
Voltage Range	43.0 — 63.0V
Continuous Battery Charging Output	120A
Charging Curve	3-Stage w/ Equalization
Grid to Batt Charging Efficiency	96.0%
External Temperature Sensor	Included
Current Shunt for Accurate % SOC	Integrated
External Gen Start Based on Voltage or %SOC	Integrated
Communication to Lithium Battery	CanBus & RS485

Input Output Power 5000W	
Max Allowed PV Power	3250W + 3250W = 6500W
Max PV Power Delivered to Battery & AC Outputs	5000W
Max DC Voltage (Voc)	500V @ 18A, 450V @ .20A
MPPT Voltage Range	150-425V
Starting Voltage	125V
Number of MPPT	2
Max Solar Strings Per MPPT	2
Max DC Current per MPPT (Self Limiting)	10A
Max AC Coupled Input (Micro/String Inverters)	9600W

JDPF
JDPF

WORR
WORR

General	
Dimensions (H x W x D)	30.0" x 18.3" x 10.0"
Weight	78 lbs
Enclosure	NEMA 3R
Ambient Temperature	-25-55°C, >45°C Derating
Installation Style	Wall-Mounted
Wi-Fi & LAN Communication	Included
Standard Warranty (verified by HALT Testing)	5 Years

AC Output Power 5kW on-grid or off-grid	
Connections	120/240/208V Split Phase
Continuous AC Power to Grid (On-Grid)	5000W 20.8A-L (240V)
Continuous AC Power to Load (Off-Grid)	5000W 20.8A-L (240V)
Surge AC Power 10sec	16,000VA L-L (240V)
Surge AC Power 100ms	25,000VA L-L (240V)
Parallel Stacking	No
Frequency	60/50Hz
Continuous AC Power with Grid or Generator	15120W 63A L-L (240V)
CEC Efficiency	96.5% (Peak 97.5%)
Idle Consumption Typical—No Load	60W
Sell Back Power Modes	Limited to Household/Fully Grid-Tied
Design (DC to AC)	Transformerless DC
Response Time (Grid-Tied to Off-Grid)	4ms
Power Factor	+/- 0.9 - 1.0

Protections & Certification	
Electronics Certified Safety by SGS Labs to NEC & UL Specs - NEC 690.4B & NEC 705.4/6	Yes
Grid Sell Back — UL1741-2010/2018, IEE-E1547a-2003/2014, FCC 15 Class B, UL1741SA,	Yes
PV DC Disconnect Switch — NEC 240.15	Integrated
Ground Fault Detection — NEC 690.5	Integrated
PV Rapid Shutdown Control — NEC 690.12	Integrated
PV Arc Fault Detection — NEC 690.11	Integrated
PV Input Lightning Protection	Integrated
PV String Input Reverse Polarity Protection	Integrated
AC Output Breakers - 63A	Integrated
250A Battery Breaker / Disconnect	Integrated
Surge Protection	DC Type II / AC Type II

Design Type	DC Transformerless					AC Coupled		
	Sol-Ark 12K	Sol-Ark 8K	Sol-Ark 5K	Generac PWRcell 7.6 +4xS2500	SolarEdge Energy Hub 7.6 32xP400	Panasonic (Darfon) 2xH5001	Enphase 2x10 +36xIQ7P	Tesla 2x Powerwall2 + String Inv
Brand & Model								
MSRP Price								\$19,400
Solar PV Continuous Power							10.4KW	
Inverter AC Continuous Power	9KW	8KW		7.6KW	7.6KW			
Inverter Battery Continuous Power							2x3.8KW	
Off Grid Inverter AC Peak Power (5s)				12KW		13KW		14KW
System Idle Power			60W					78W
AC to DC Charger			120A	6.7KW	5KW?	120A	N/A	N/A
User Interface							X	X
PV to Batt Efficiency @ 65%				93.0%			95.0%	95.0%
AC to Batt Efficiency @ 65%				93.0%				
Batt to AC Efficiency @ 65%								
On Grid PV to AC Efficiency @ CEC				95.5%		95.5%		
Time of Use or Off Grid PV -> Batt -> AC Losses @ 65%							13%	13%
Grid Failure UPS Transfer Time						20ms		
Low Cost Easy Install								
Warranty		5/10 yr	5 yr					
AC Coupling to existing Inverters	✓	✓	✓		✓	✓	✓	✓
Parallel Stacking	✓				✓	✓	✓	✓
120/240/208V 3Phase	✓			✓				✓
Generator Charging	✓	✓	✓					
AC Load Shedding for TOU & Off Grid	✓	✓	✓	✓				
California & HECO (Grid Sell)	✓	✓		✓	✓	✓	✓	✓
NEC UL1699B Arc Fault	✓	✓	✓	✓	✓		✓	✓
Outdoor Enclosure	✓	✓	✓	✓	✓		✓	✓
Battery Bank				18KWh 3500c +\$13K				28KWh 3500cycles

JDPF
JDPF

WRR
WRR

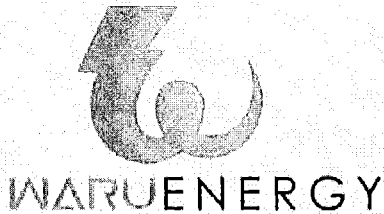

WARU HYBRID INVERTER 7.6KW AND 11.4KW

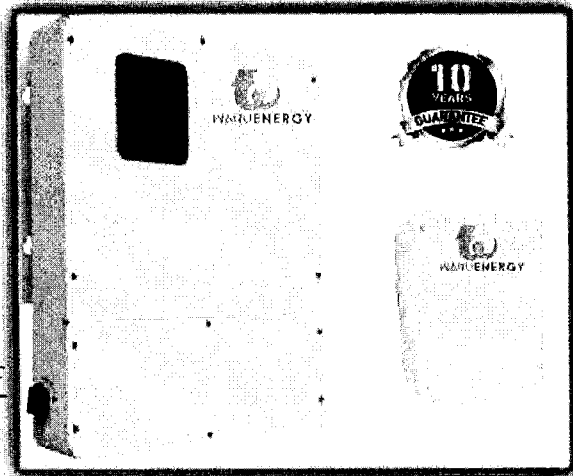

JDPF
JDPF

WRR
WRR

FLEXIBLE

- The model covers 7.6kW – 11.4kW, with unified appearance design.
- Compatible with WARU LiFePO4 battery modules.
- Up to 10 inverters in parallel
- 10 years warranty

GRACE

- Fashionable appearance, convenient wiring.
- IP65 design, natural cooling, external fan free design, low noise, improve the whole machine life.

RELIABLE

- Battery reverse connect protection, the charge and discharge are controlled by intelligent software to improve the battery life.
- Input and Output lightning protection, PV arcing detection.
- Discharge at full power and disconnect the charger automatically when the battery is full.
- Off-grid full power output, transient 1.5 times overload, soft start mode, with air conditioning, water pump and other loads.
- Insulation detection, leakage battery, ground fault detection, island protection to prevent

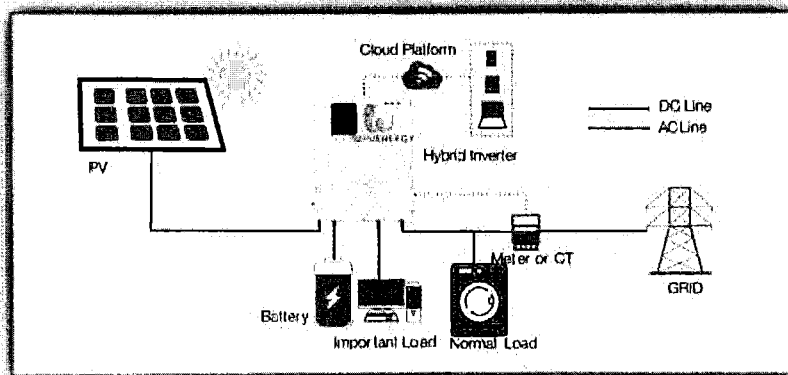
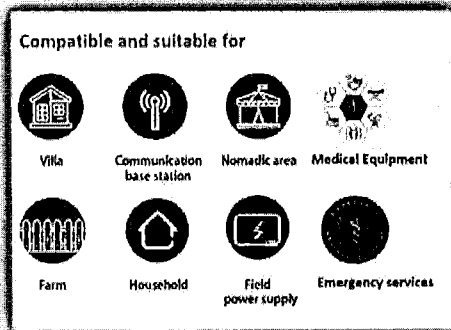

WARU ENERGY, LLC
 Industrial Víctor M Fernández
 315 calle 3
 San Juan, PR 00926

Tel. (787) 680-0008
www.waruenergy.com
office@waruenergy.com



MODEL	WRU7.6KW	WRU11.4KW
PV INPUT		
PV INPUT POWER	10KW	14.82KW
MPPT NUMBER	4	4
PV VOLTAGE RANGE	150-500V	150-500V
MAX PV INPUT VOLTAGE	500V	500V
EACH MPPT INPUT CURRENT	13A	14A
AC OUTPUT (ON GRID)		
RATED AC OUTPUT	120/208/240V 7.6KVA	120/208/240 11.4KVA
AC OUTPUT VOLTAGE	120/240 SPLIT PHASE, 208 TWO/THREE PHASE	120/240 SPLIT PHASE, 208 TWO/THREE PHASE
AC OUTPUT FREQUENCY	50/60Hz	50/60Hz
MAX OUTPUT CURRENT	32A	47.5A
AC REVERSE CHARGING	YES	YES
POWER FACTOR	0.8leading...0.8lagging	0.8leading...0.8lagging
THDI	<2%	<2%
BACKUP AC OUTPUT		
RATED BACKUP OUTPUT POWER	7.6KVA	11.4KVA
MAX BACKUP OUTPUT POWER	9.5KVA 60S / 11.4KVA 15	14.25KVA 60S / 17.1KVA 15
BACKUP AC OUTPUT VOLTAGE	120/240 SPLIT PHASE, 208 TWO/THREE PHASE	120/240 SPLIT PHASE, 208 TWO/THREE PHASE
AC FREQUENCY	50/60Hz	50/60Hz
OUTPUT THDI	<2%	<2%
BATTERY		
MAX CHARGE & DISCHARGE CURRENT	100A/100A	100A/100A
BATTERY VOLTAGE RANGE	96V ~ 336V	96V ~ 336V
BATTERY CAPACITY RANGE	6.6 to 66kWh	6.6 to 66kWh
BATTERY TYPE	Lithium LiFePO4	Lithium LiFePO4
COMMUNICATION	CAN, RS485	CAN, RS485
EFFICIENCY		
MAX EFFICIENCY	≥98.2%	≥98.2%
CEC EFFICIENCY	≥97.2%	≥97.2%
PROTECTION		
COMPLETE PROTECTION	Ground protection;AFCI protection;islanding protection;DC disconnect detection;Battery Reverse protection;Battery charge and discharge protection;insulation testing;GFCI;DC&AC anti thunder;Overvoltage and under-voltage protections;AC&DC over-current protection;AC short-circuit current protection;overheating protection	
GENERAL DATA		
AC AND BACKUP OUTPUT CONDUIT SIZE	25.4MM	25.4MM
PV INPUT CONDUIT SIZE	25.4MM	25.4MM
BATTERY INPUT CONDUIT SIZE	34.5MM	34.5MM
OPERATION TEMPERATURE RANGE	-25 ~ +60°C	-25 ~ +60°C
ENVIRONMENT HUMIDITY	0-95%	0-95%
ALTITUDE	0~4000M (Derating when over 2000m)	0~4000M (Derating when over 2000m)
IP GRADE	IP65	IP65
WEIGHT	30kg	30kg
DIMENSION (W x H x D)	530x660x200mm	530x660x200mm
COOLING	NATURAL COOLING	NATURAL COOLING
NOISE EMISSION (dB)	<25dB	<29dB
DISPLAY	LCD	LCD
COMMUNICATION	MODBUS, RS485, WIFI, 4G	MODBUS, RS485, WIFI, 4G
SELF-CONSUMPTION AT NIGHT	<2.5W (with battery enabling < 5W)	<2.5W (with battery enabling < 5W)
NO TRANSFORMER	YES	YES
SAFETY	UL1741 SA all options, UL1699B, CSA 22.2	UL1741 SA all options, UL1699B, CSA 22.2
EMC	FCC PART 15 CLASS B	FCC PART 15 CLASS B
WARRANTY	10 YEARS	10 YEARS

JDPF
JDPF

WRRR
WRRR

WARU ENERGY, LLC
Industrial Víctor M Fernández
315 calle 3
San Juan, PR 00926

Tel. (787) 680-0008
www.waruenergy.com
office@waruenergy.com



Enphase Encharge 3

The **Enphase Encharge 3™** all-in-one AC-coupled storage system is **reliable, smart, simple, and safe**. It has a total usable energy capacity of 3.36 kWh and includes four embedded grid-forming microinverters with 1.28 kW power rating. It provides backup capability and installers can quickly design the right system size to meet the needs of both new and retrofit solar customers.

JDPF
JDPF

WORR
WORR

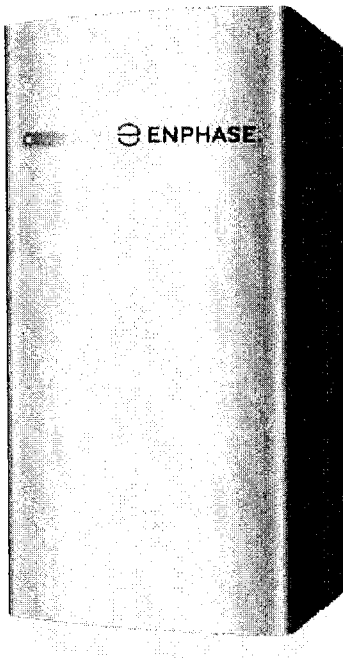

Reliable

- Proven high-reliability IQ Series Microinverters
- Ten-year limited warranty
- Four embedded IQ 8X-BAT Microinverters
- Passive cooling (no moving parts/fans)

Smart

- Grid-forming capability for backup operation
- Remote software and firmware upgrade
- Mobile app-based monitoring and control
- Support for self consumption
- Utility time of use (TOU) optimization

Simple

- Fully integrated AC battery system
- Quick and easy plug-and-play installation
- Interconnects with standard household AC wiring

Safe

- Battery safety tested
- Lithium iron phosphate (LFP) chemistry for maximum safety and longevity

Enphase Encharge 3

MODEL NUMBER	
ENCHARGE-3-1P-NA	Encharge 3 battery storage system with integrated Enphase Microinverters and battery management unit (BMU). Includes: - One Encharge 3,36 kWh base unit (B03-A01-US00-1-3) - One Encharge 3 cover kit with cover and wall mounting bracket (B03-C-0350-0)
ACCESSORIES	
ENCHARGE-HNDL-R1	One set of Encharge base unit installation handles
OUTPUT (AC) @240 VAC ¹	
Rated (continuous) output power	1.28 kVA
Peak output power	1.92 kVA (10 seconds)
Nominal voltage / range	240/211–264 VAC
Nominal frequency / range	60/57–63 Hz
Rated output current	5.3 A
Peak output current	8.2A (10 seconds)
Power factor (adjustable)	0.85 leading ... 0.85 lagging
Maximum units per 20 A branch circuit	Three units (single phase)
Interconnection	Single phase
Maximum AC short circuit fault current over 3 cycles	23.2 Arms
Round trip efficiency ²	89%
BATTERY	
Total capacity	3.5 kWh
Usable capacity	3.36 kWh
Round trip efficiency	96%
Nominal DC voltage	67.2 V
Maximum DC voltage	73.5 V
Ambient operating temperature range	-15° C to 55° C (5° F to 131° F) non-condensing
Optimum operating temperature range	0° C to 30° C (32° F to 86° F)
Chemistry	Lithium iron phosphate (LFP)
MECHANICAL DATA	
Dimensions (WxHxD)	367 mm x 664 mm x 319mm (14.45 in x 26.14 in x 12.56 in)
Weight	One individual 44.2 kg (97.4 lbs) base unit plus 7.8 kg (17.2 lbs) cover and mounting bracket; total 52 kg (114.6 lbs)
Enclosure	Outdoor – NEMA 3R
IQ 8X-BAT microinverter enclosure	NEMA type 6
Cooling	Natural convection – No fans
Altitude	Up to 2500 meters (8200 feet)
Mounting	Wall mount
FEATURES AND COMPLIANCE	
Compatibility	Compatible with grid-tied PV systems. Compatible with Enphase M215/M250 and IQ Series Micros, Enphase Enpower, and Enphase IQ Envoy for backup operation.
Communication	Wireless 2.4 GHz
Services	Backup, self-consumption, TOU, Demand Charge, NEM Integrity
Monitoring	Enlighten Manager and MyEnlighten monitoring options; API integration
Compliance	UL 9540, UN 38.3, UL 9540A, UL 1998, UL 991, NEMA Type 3R, AC156 EMI: 47 CFR, Part 15, Class B, ICES 003 Cell Module: UL 1973, UN 38.3 Inverters: UL 62109-1, IEC 62109-2, UL 1741SA, CAN/CSA C22.2 No. 107.1-16, and IEEE 1547
LIMITED WARRANTY	
Limited Warranty ³	>70% capacity, up to 10 years or 4000 cycles

1. Supported in backup/off-grid operation.
2. AC to battery to AC at 50% power rating.
3. Whichever occurs first. Restrictions apply.

To learn more about Enphase offerings, visit enphase.com

© 2021 Enphase Energy. All rights reserved. Enphase, the Enphase logo, Encharge 10, and other trademarks or service names are the trademarks of Enphase Energy, Inc. Data subject to change. 2021-02-10



Enphase IQ Combiner 3C (X-IQ-AM1-240-3C)

JDPF
JDPF

WORR
WORR

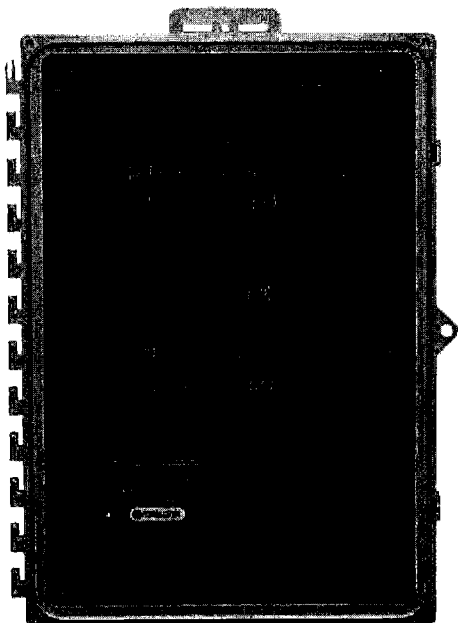

The Enphase IQ Combiner 3C™ with Enphase IQ Envoy™ and integrated LTE-M cell modem with 5-year data plan consolidates interconnection equipment into a single enclosure and streamlines PV and storage installations by providing a consistent, pre-wired solution for residential applications. It offers up to four 2-pole input circuits and Eaton BR series busbar assembly.

Smart

- Includes IQ Envoy for communication and control
- Includes LTE-M cell modem and 5-year data plan
- Flexible networking supports Wi-Fi, Ethernet, or cellular
- Optional AC receptacle available for PLC bridge
- Provides production metering and optional consumption monitoring

Simple

- Reduced size from previous combiner
- Centered mounting brackets support single stud mounting
- Supports back and side conduit entry
- Up to four 2-pole branch circuits for 240 VAC plug-in breakers (not included)
- 80 A total PV or storage branch circuits

Reliable

- Durable NRTL-certified NEMA type 3R enclosure
- Five-year limited warranty
- UL listed



LISTED

To learn more about Enphase offerings, visit enphase.com

 ENPHASE

Enphase IQ Combiner 3C

MODEL NUMBER

IQ Combiner 3C X-IQ-AM1-240-3C	IQ Combiner 3C with Enphase IQ Envoy™ printed circuit board for integrated revenue grade PV production metering (ANSI C12.20 +/- 0.5%) and optional* consumption monitoring (+/- 2.5%). Includes Enphase Mobile Connect LTE-M cell modem and five-year data plan. A plug-and-play industrial-grade cellular modem with data plan for systems up to 60 microinverters. (Available in the US, Canada, Mexico, Puerto Rico, and the US Virgin Islands, where there is adequate cellular service in the installation area.)
-----------------------------------	---

ACCESSORIES and REPLACEMENT PARTS

Consumption Monitoring* CT CT-200-SPLIT	(not included, order separately)
* Consumption monitoring is required for Enphase Storage Systems	
Wireless USB adapter COMMS-KIT-01	Split core current transformers enable whole home consumption metering (+/- 2.5%). Installed at the IQ Envoy. For communications with Enphase Encharge™ storage and Enphase Enpower™ smart switch. Includes USB cable for connection to IQ Envoy or Enphase IQ Combiner™ and allows redundant wireless communication with Encharge and Enpower.
Circuit Breakers BRK-10A-2-240 BRK-15A-2-240 BRK-20A-2P-240	Supports Eaton BR210, BR215, BR220, BR230, BR240, BR250, and BR260 circuit breakers. Circuit breaker, 2 pole, 10A, Eaton BR210 Circuit breaker, 2 pole, 15A, Eaton BR215 Circuit breaker, 2 pole, 20A, Eaton BR220
EPLC-01	Power line carrier (communication bridge pair), quantity - one pair
XA-PLUG-120-3	Accessory receptacle for Power Line Carrier in IQ Combiner 3C (required for EPLC-01)
XA-ENV-PCBA-3	Replacement IQ Envoy printed circuit board (PCB) for Combiner 3C

ELECTRICAL SPECIFICATIONS

JDPF Rating	Continuous duty
JDPF System voltage	120/240 VAC, 60 Hz
Eaton BR series busbar rating	125 A
WORR Max. continuous current rating (output to grid)	65 A
WORR Max. fuse/circuit rating (output)	90 A
Branch circuits (solar and/or storage)	Up to four 2-pole Eaton BR series Distributed Generation (DG) breakers only (not included)
Max. continuous current rating (input from PV)	64 A
Max. total branch circuit breaker rating (input)	80A of distributed generation / 90A with IQ Envoy breaker included
Production Metering CT	200 A solid core pre-installed and wired to IQ Envoy

MECHANICAL DATA

Dimensions (WxHxD)	37.5 x 49.5 x 16.8 cm (14.75" x 19.5" x 6.63"). Height is 21.06" (53.5 cm) with mounting brackets.
Weight	7.5 kg (16.5 lbs)
Ambient temperature range	-40° C to +46° C (-40° to 115° F)
Cooling	Natural convection, plus heat shield
Enclosure environmental rating	Outdoor, NRTL-certified, NEMA type 3R, polycarbonate construction
Wire sizes	<ul style="list-style-type: none"> • 20 A to 50 A breaker inputs: 14 to 4 AWG copper conductors • 60 A breaker branch input: 4 to 1/0 AWG copper conductors • Main lug combined output: 10 to 2/0 AWG copper conductors • Neutral and ground: 14 to 1/0 copper conductors Always follow local code requirements for conductor sizing.
Altitude	To 2000 meters (6,560 feet)

INTERNET CONNECTION OPTIONS

Integrated Wi-Fi	802.11b/g/n
Cellular	CELLMODEM-M1 (4G based LTE-M)
Ethernet	Optional, 802.3, Cat5E (or Cat 6) UTP Ethernet cable (not included)

COMPLIANCE

Compliance, Combiner	UL 1741, CAN/CSA C22.2 No. 107.1, 47 CFR, Part 15, Class B, ICES 003 Production metering: ANSI C12.20 accuracy class 0.5 (PV production)
Compliance, IQ Envoy	UL 60601-1/CANCSA 22.2 No. 61010-1

To learn more about Enphase offerings, visit enphase.com

Enphase IQ 7A Microinverter

JDPF
JDPF

W0RR
W0RR

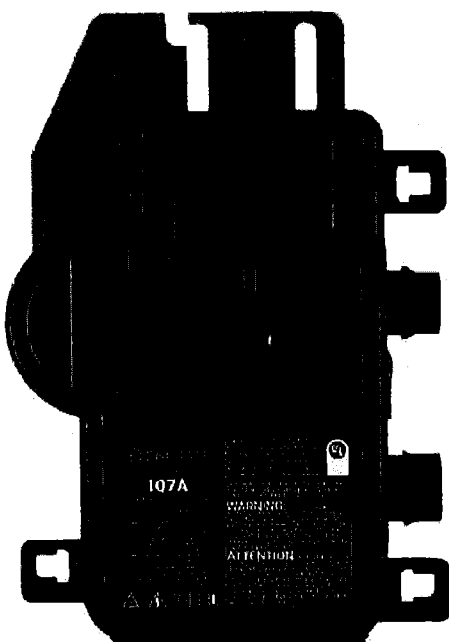

The high-powered smart grid-ready **Enphase IQ 7A Micro™** dramatically simplifies the installation process while achieving the highest system efficiency for systems with 60-cell and 72-cell modules.

Part of the Enphase IQ System, the IQ 7A Micro integrates with the Enphase IQ Envoy™, Enphase IQ Battery™, and the Enphase Enlighten™ monitoring and analysis software.

The IQ Series Microinverters extend the reliability standards set forth by previous generations and undergo over a million hours of power-on testing, enabling Enphase to provide an industry-leading warranty of up to 25 years.

High Power

- Peak output power 366 VA @ 240 VAC and 295 VA @ 208 VAC

Easy to Install

- Lightweight and simple
- Faster installation with improved, lighter two-wire cabling
- Built-in rapid shutdown compliant (NEC 2014, 2017 & 2020)

Efficient and Reliable

- Optimized for high powered 60-cell and 72-cell modules
- Highest CEC efficiency of 97%
- More than a million hours of testing
- Class II double-insulated enclosure
- UL listed

Smart Grid Ready

- Complies with advanced grid support, voltage and frequency ride-through requirements
- Envoy and Internet connection required
- Configurable for varying grid profiles
- Meets CA Rule 21 (UL 1741-SA)



To learn more about Enphase offerings, visit enphase.com

 ENPHASE

Enphase IQ 7A Microinverter

INPUT (DC)	IQ7A-72-2-US	
Commonly used module pairings ¹	295 W–460 W +	
Module compatibility	60-cell, 66-cell and 72-cell PV modules	
Maximum input DC voltage	58 V	
Power point tracking voltage range ²	18 V–58 V	
Min/Max start voltage	33 V / 58 V	
Max DC short circuit current (module I _{sc}) ³	15 A	
Overvoltage class DC port	II	
DC port backfeed current	0 A	
PV array configuration	1 x 1 ungrounded array; No additional DC side protection required; AC side protection requires max 20A per branch circuit	
OUTPUT (AC)	@ 240 VAC	@ 208 VAC
Peak output power	366 VA	295 VA
Maximum continuous output power	349 VA	290 VA
Nominal (L-L) voltage/range ⁴	240 V / 211–264 V	208 V / 183–229 V
Maximum continuous output current	1.45 A (240 VAC)	1.39 A (208 VAC)
Nominal frequency	60 Hz	
Extended frequency range	47–68 Hz	
AC short circuit fault current over 3 cycles	5.8 Arms	
Maximum units per 20 A (L-L) branch circuit ⁵	11 (240 VAC)	11 (208 VAC)
Overvoltage class AC port	III	
AC port backfeed current	18 mA	
Power factor setting	1.0	
Power factor (adjustable)	0.85 leading ... 0.85 lagging	
EFFICIENCY	@240 VAC	@208 VAC
CEC weighted efficiency	97.0 %	96.5%
MECHANICAL		
Ambient temperature range	-40°C to +60°C	
Relative humidity range	4% to 100% (condensing)	
Connector type: DC (IQ7A-72-2-US)	MC4	
Dimensions (HxWxD)	212 mm x 175 mm x 30.2 mm (without bracket)	
Weight	1.08 kg (2.38 lbs)	
Cooling	Natural convection – No fans	
Approved for wet locations	Yes	
Pollution degree	PD3	
Enclosure	Class II double-insulated, corrosion resistant polymeric enclosure	
Environmental category / UV exposure rating	NEMA Type 6 / outdoor	
FEATURES		
Communication	Power Line Communication (PLC)	
Monitoring	Enlighten Manager and MyEnlighten monitoring options Compatible with Enphase IQ Envoy	
Disconnecting means	The AC and DC connectors have been evaluated and approved by UL for use as the load-break disconnect required by NEC 690.	
Compliance	CA Rule 21 (UL 1741-SA) UL 62109-1, UL1741/IEEE1547, FCC Part 15 Class B, ICES-0003 Class B, CAN/CSA-C22.2 NO. 107.1-01 This product is UL Listed as PV Rapid Shut Down Equipment and conforms with NEC 2014, NEC 2017, and NEC 2020, section 690.12 and C22.1-2015 Rule 64-218 Rapid Shutdown of PV Systems, for AC and DC conductors, when installed according manufacturer's instructions.	

JDPF
JDPF

WORR
WORR

1. No enforced DC/AC ratio. See the compatibility calculator at <https://enphase.com/en-us/support/module-compatibility>.
2. CEC peak power tracking voltage range is 38 V to 43 V.
3. Maximum continuous input DC current is 10.2A.
4. Voltage range can be extended beyond nominal if required by the utility.
5. Limits may vary. Refer to local requirements to define the number of microInverters per branch in your area.

To learn more about Enphase offerings, visit enphase.com



Certificación de Equipos de Energía Renovable

Datos de la Solicitud

De acuerdo a la información suministrada se solicita la certificación para equipo(s) de energía renovable Comercial-Privado, en territorio del Estado Libre Asociado de Puerto Rico, según indicado(s) a continuación:

Solicitante: Gabriel E Ferrer

Correo Electrónico: gferrer@enphase.com

Compañía: Enphase Energy, Inc.

Datos de Equipo Certificado

Tipo de Equipo(s): Batería

Clasificación: Equipo Nuevo

MARCA	MODELO	CERTIFICACIONES	ESPECIFICACIONES
Enphase	ENCHARGE-3-1P-NA		Capacidad: 19 Ah Voltaje Nominal: 67 VDC Tipo de Batería: Litio Hierro Fosfato Tipo de Carga y Descarga: 1.28 KVA Dimensiones Nominales: 664mm x 367mm x 319mm Peso nominal: 115 lbs. Garantía Manufactura: 10 año(s)

JDPF
JDPF

División de Edificabilidad

Se recomienda la instalación del equipo de fuente de energía renovable sometido ante la OGPe, a tenor con el Reglamento para la Certificación de Sistemas de Energía Renovable y el Reglamento Conjunto para Obras de Construcción y Usos de Terrenos, vigentes.

WORR
WORR

Condiciones Especiales

Bajo ninguna circunstancia, deberá interpretarse que esta certificación implique la aprobación de instalación de equipos en un proyecto de construcción, ni que se autorice iniciar obras de construcción de clase alguna, sin el trámite del correspondiente permiso de construcción.

Firmas / Sellos

Fecha de Expedición:

19/JUN/2020

Ing. Gabriel Hernández
Secretario Auxiliar
Departamento de Desarrollo Económico y Comercio de Puerto Rico
Oficina de Gerencia de Permisos

Ing. Gabriel Hernández Rodríguez

Secretario Auxiliar



Life Is On



Conext™ XW Series Power Distribution

Easy to install, flexible and scalable
balance of system solutions

JDPF Conext™ XW Power Distribution Panels offer flexibility for your solar and storage system design, including:

- WORR • **Mini-Power Distribution Panel and Power Distribution Panel**
- **XW Connection Kit**
- **XW Conduit Box**
- **Compatible Breakers**

Configuration with XW PDP

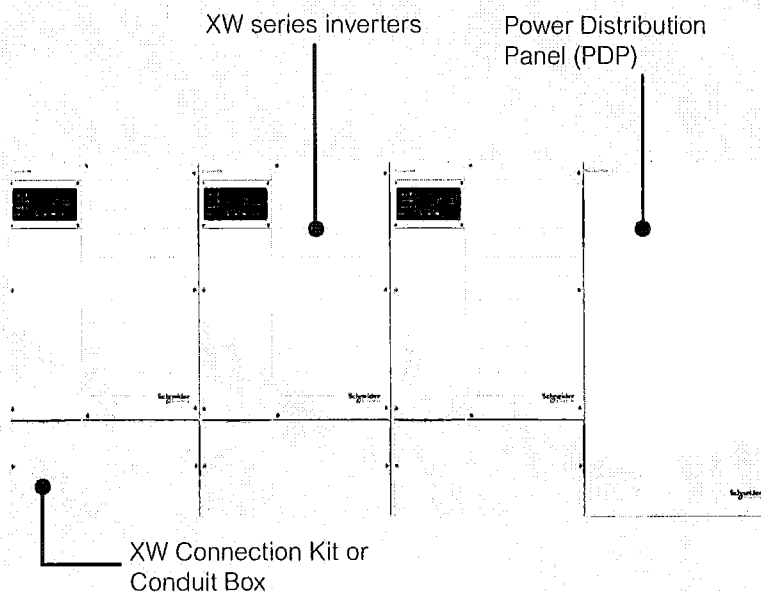

Configuration with XW Mini PDP

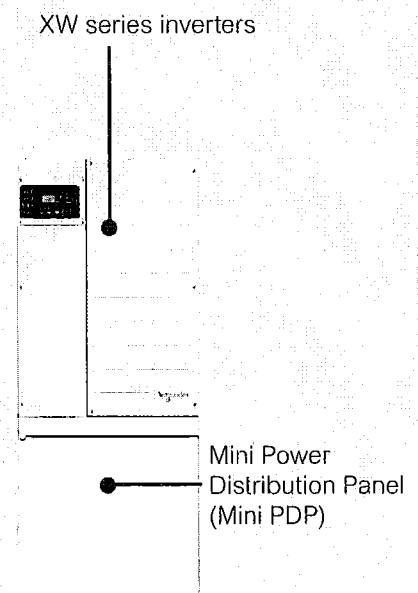

XW Mini Power Distribution Panel

The XW Mini Power Distribution Panel (Mini PDP) provides a compact, easy to install DC and AC power distribution cabinet compatible with the Conext XW series inverters. The Mini PDP can be used for managing power distribution to the XW inverter, MPPT Charge Controllers, the battery, and a generator.

The PDP is designed for compact installation below the XW inverter and easy installation:

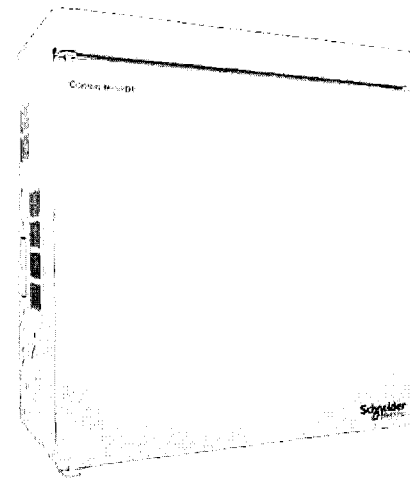

JDPF
JDPF

- Includes a main 250 A DC breaker for the battery
- Includes AC breakers for AC input, Bypass, and AC Out (load)
- Breaker expansion positions on DC side for solar charge controllers and AC side for generator or AC coupled PV inverter
- AC wiring and DC bus bars for direct connection to the XW inverter
- Split phase, single phase applications
- Mounts below the XW inverter
- Multiple conduit knockouts and a field reversible door

WORR
WORR

- Compatible with Conext MPPT charge controllers, and includes mounting provisions for MPPT 60 150 Charge Controllers on the either side
- Saves installation time with a pre-wired solution

XW Mini PDP	
Part number	865-1013-01
Standards	UL
AC Distribution	
Included breakers	Three 60 A, 120/240 Vac, two-pole, Square D QOU260 AC breakers for AC input, bypass and AC load (factory-installed)
Mounting	DIN rail (35 mm)
Breaker expansion positions	One additional expansion position for a 2 pole Square D QOU breaker
AC wiring	Factory installed and labeled Arctic Ultraflex Blue™ wiring, including five #6 AWG Arctic AC cables for AC connections: L1, L2, Neutral
DC Distribution	
Included breakers	One GJ 250A 160 Vdc, 3/8" stud DC breaker installed
Mounting	Panel mounted
Breaker expansion positions	2 expansion positions for charge controller DC breakers. Can be used for outputs of MPPT 60/80/100, as well as MPPT 60 input.
DC wiring	Integrated DC busbars for easy installation with the XW series inverters
General Specifications	
Wiring connections	Termination lugs for ground, AC neutral and DC bus bar for battery connection
Enclosure	Indoor rated, field-reversible panel door and integrated wall mounting bracket
Certification	UL1741, CSA107.1
Product dimensions (H x W x D)	47.0 x 40.6 x 22.5 cm (18.5 x 16 x 8.9 in). 24.9 in door swing clearance, measured from back of unit
Shipping dimensions (H x W x D)	53.5 x 56.5 x 33 cm (21.0 x 28.6 x 13.0 in)
Shipping weight	13 kg (28.2 lb)

XW Power Distribution Panel

The XW Power Distribution Panel (PDP) provides an easy to install DC and AC power distribution cabinet compatible with the Conext XW series inverters. The PDP can be used for managing power distribution for up to three XW inverters, MPPT Charge Controllers, the battery, and a generator.

The PDP is designed for easy installation and flexibility:

- Includes a main 250 A DC breaker for the battery
- Available with or without AC breakers for AC input, Bypass, and AC Out (load)
- Breaker expansion positions on DC side for solar charge controllers and additional battery disconnects/breakers and AC side for additional inverters, generator or AC coupled PV inverter
- Compatible with up to three XW inverters

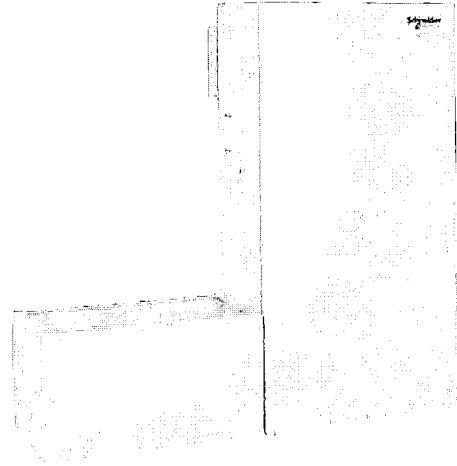

- JDPF**
JDPF
- Provision for mounting surge arresters e.g. Square D SDSA1175, Square D SDSA3650
 - Extremely flexible Arctic Ultraflex Blue™ wiring for direct connection to the XW inverter as described in the specifications

- WORR**
WORR
- Split phase, single phase, and three phase applications
 - Mount on either side of the XW inverter, multiple conduit knockouts and a field reversible door
 - Mounts flush beside Conext 600V MPPT Charge Controllers. Includes mounting provisions for two MPPT 60 150 Charge Controllers on the side
 - Saves installation time with factory installed, ready to connect wiring
 - Includes a Conduit Box and mounting plate for seamless integration with XW inverters

	XW PDP with AC Breakers	XW PDP without AC Breakers
Part number	865-1015-01	865-1014-01
Standards	UL	UL / IEC
AC Distribution		
Included breakers	Three 60 A, 120/240 Vac, two-pole, Square D QOU260 AC breakers for AC input, bypass and AC load (factory-installed)	Breakers not included. Refer to compatible breaker accessories.
Mounting	DIN rail (35 mm)	DIN rail (35 mm)
Breaker expansion positions	Six expansion positions	Nine 2-pole expansions (QOU breakers)
AC wiring	Factory installed and labeled Arctic Ultraflex Blue™ wiring, including five #6 AWG AC cables for AC connections: L1, L2, Neutral	AC wiring not included
DC Distribution		
Included breakers	One GJ 250A 160 Vdc DC, 3/8" stud breaker installed	
Mounting	Panel mounted	
Breaker expansion positions	Two expansion positions for battery 250A DC breakers Eight expansion positions for charge controller DC breakers	
DC wiring	One pair of Arctic Ultraflex Blue™ #4/0 AWG battery cables	
General Specifications		
Wiring connections	Termination lugs for ground, AC neutral and DC bus bar for battery connection	
Enclosure	Indoor rated, field-reversible panel door. A wall mount bracket is included, as well as an XW Conduit box for wiring to the XW terminals.	
Product dimensions (H x W x D)	76.1 x 40.6 x 21.0 cm (30.0 x 16.0 x 8.3 in)	
Shipping dimensions (H x W x D)	122.0 x 53.3 x 34.3 cm (48.0 x 21.0 x 13.5 in)	
Shipping weight	30.5 kg (67.2 lb)	

XW Connection Kit for Additional Inverters

The XW Connection Kit is used for connecting a second or third XW inverter to a Power Distribution Panel (PDP). One XW Connection Kit is used for each of the additional XW Inverters.

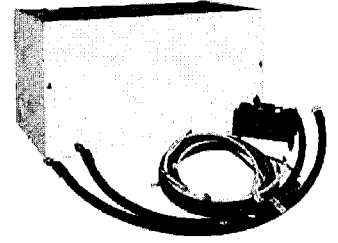

The XW Connection Kit is designed for easy installation of multiple inverter systems and includes:

- XW Conduit Box
- Includes a main 250A DC breaker for the battery
- One pair #4/0 AWG battery cables, 64" length to reach from the third inverter to the PDP
- Five #6 AWG cables for AC In (grid), AC Out (load), and neutral
- AC Sync and Xanbus cables for network communication
- DC positive bus bar for up to 3 DC disconnect breakers for installation in the PDP

XW Installation Kit for INV2 INV 3 PDP

Part number	865-1020-02
General Specifications	
Product dimensions (H x W x D)	22.9 x 40.6 x 21.0 cm (8.5 x 16.0 x 8.3 in)
Shipping dimensions (H x W x D)	44.5 x 33.3 x 30.5 cm (17.5 x 13.0 x 12.0 in)
Shipping weight	10.5 kg (23.1 lb)

JDPF

JDPF

WORR

WORR

XW Conduit Box

The XW Conduit Box mounts directly to the bottom of an XW inverter to safely protect end-users from inadvertent contact with wiring or connections. The XW Conduit Box is bundled with the Power Distribution Panel and the XW Connection Kit, however, it is also available for order on its own.

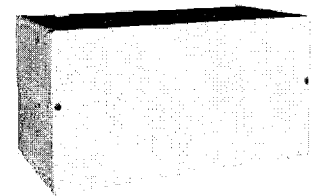

The Conduit Box is easily secured with two screws provided on the bottom of the inverter. The bottom flange of the conduit box can then be attached (fasteners not provided) to the wall to complete the installation. The front panel of the conduit box can be removed by removing the two screws on the front, allowing ample space to make all necessary wiring connections.

In multi-unit installations, the sides of adjacent conduit boxes can be removed to create an effective raceway with lots of volume to run AC and DC inverter cabling. The conduit box also includes multiple cable strap points, allowing the final installation to look clean and professional.

In addition, an internal sheet metal barrier is included to keep communications wires separate from AC and DC power wires.

XW Conduit Box

Part number	865-1025-01
General Specifications	
Product dimensions (H x W x D)	22.9 x 40.6 x 21.0 cm (8.5 x 16.0 x 8.3 in)
Shipping dimensions (H x W x D)	44.5 x 33.0 x 30.5 cm (17.5 x 13.0 x 12.0 in)
Shipping weight	4.6 kg (10.0 lb)

Compatible AC breakers for XW Power Distribution Panel

Application	Compatible Breakers
UL Standards	
120/240 VAC	60 A, 120/240 VAC Breaker Kit (865-1215-01); or Customize with Square D type QOU DIN-rail mount breakers
120/208 VAC	60 A, Three-Phase Breaker Kit (865-1315-01); or Customize with Square D type QOU DIN-rail mount breakers
IEC Standards	
230 VAC	Schneider Electric Acti9 and Multi9 DIN-rail mount breakers

60 A, 120/240 VAC Breaker Kit

JDPF
JDPF
WORR
WORR

The 60 A, 120/240 VAC Breaker Kit is used for AC distribution for a second or third XW inverter connection to the Power Distribution Panel. If the Power Distribution Panel was ordered with AC breakers, a single breaker kit can be used for connecting two or three inverters. With two inverters, the three additional breakers are used for AC in (grid), bypass, and AC Out (load). With three inverters the breakers in the PDP are used for AC in (grid) and AC Out (load), and bypass functionality would be installed externally (not included). Includes:

- Three 60A, 120/240 Vac, two-pole, Square D, type QOU, DIN-rail mountable AC breakers
- Four Jumpers with four tabs each
- Bypass interlock plate for dual inverter systems

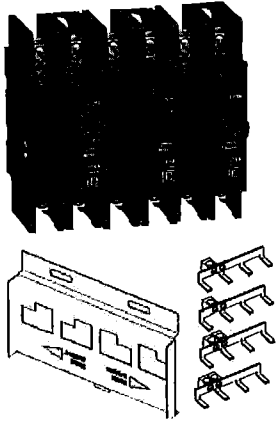

XW Conduit Box	
Part number	865-1215-01

60 A, Three-Phase Breaker Kit

The 60 A, Three-Phase Breaker Kit is used to connect three XW+ inverters in a 120/208V three phase configuration in the Power Distribution Panel. The three, 60A three-pole breakers are used for connecting AC In (grid), bypass, and AC Out (load). Includes:

- Three 60A, 120/208 Vac, three-pole, Square D QOU360, DIN-rail mountable AC breakers
- Power distribution jumpers
- Bypass interlock for three-phase systems using three XW inverters

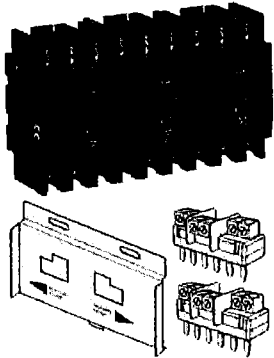

Three-Phase Breaker Kit for XW PDP	
Part number	865-1315-01

DC Breaker Accessories

Compatible with XW Power Distribution Panels.

	Single Unit Part Number	Masterpack Part Number	Masterpack Qty	Application
Battery Disconnect/Breaker				
250A, 160VDC, Panel Mount DC Breaker	865-DCBRK-250	865-1065	6 units	XW inverter connection to battery
Charge Controller Breakers				
125A, 125VDC, Panel Mount DC Breaker	865-DCBRK-125	-	-	MPPT 100 600 output connection to battery
100A, 125VDC, Panel Mount DC Breaker	865-DCBRK-100	865-1080	12 units	MPPT 80 600 output connection to battery
80A, 125VDC, Panel Mount DC Breaker	865-DCBRK-80	865-1070	12 units	MPPT 60 150 output connection to battery
60A, 160VDC, Panel Mount DC Breaker	865-DCBRK-60	865-1075	48 units	MPPT 60 150 input connection to PV array. Not used when the MPPT 60 150 is installed with MPPT Disconnect RS

JDPF
JDPF

WORR
WORR

Example XW Power Distribution Configurations

The following table shows example ordering information for some typical configurations. Other configurations are also possible such as adding additional MPPT charge controllers or integrating PV with AC Coupling. Please refer to the Mini-PDP, PDP, and other product specifications and manuals for more information.

	Part Number	1 XW 120/240V 1 MPPT	2 XW 120/240V 2 MPPT	3 XW 120/240V 3 MPPT	3 XW 3-phase 3 MPPT
XW Pro or XW+	865-6848-21 or 865-6848-01	1	2	3	3 ¹
MPPT 100 600 or MPPT 80 600	865-1034 or 865-1032	1	2	3	3
Optional: MPPT Disconnect RS	865-1036 and 865-1039	1 1	1 1	2 1	2 1
XW Mini PDP	865-1013-01 ²	1			
XW PDP with AC Breakers	865-1015-01 ²		1	1	
XW PDP without AC Breakers	865-1014-01				1
XW Connection Kit	865-1020-02		1	2	2
60A 120/240 VAC Breaker Kit	865-1215-01 ²		1	1	
60A Three Phase Breaker Kit	865-1315-01 ²				1
Charge Controller Output Breaker	Refer to DC breaker accessories	1	2	3	3
Optional: Extra AC Breakers for Generator Integration	Refer to AC breaker accessories	One 2-pole	Two 2-pole	Three 2-pole	One 3-pole
Manual Bypass		Included	Included with 865-1215-01	Installed externally (not included)	Included with 865-1315-01

¹ XW+ must be used for three-phase applications

² For IEC markets, substitute the PDP without AC Breakers (865-1014-01), and refer to compatible AC breaker accessories.



Schneider Electric Solar CONTRACTUAL WARRANTY

This Schneider Electric Solar Contractual Warranty applies to the following products:

- CONEXT CL125A grid tie string Inverter model: PVSCL125A
- CONEXT CL60A grid tie string Inverter model: PVSCL60A
- CONEXT XW PRO 6848 NA model: 865-6848-21

Geographic Validity:

These warranty conditions apply to the United States of America, including their 50 states and commonwealths of Puerto Rico and Northern Mariana Islands (excluding their associated islands and overseas territories).

JDPF
JDPF

Warranty Duration:

- Five (5) years, unless applicable law requires a longer period, in which case it will be that period of time.
- You may obtain an additional promotional five (5) years of warranty, for a total of ten (10) years, provided that You register Your Product within six (6) months from the date of the Schneider Electric Solar commercial invoice via the instructions provided. Additional information can be found at <http://solar.schneider-electric.com/product-registration>.

WDRR
WDRR

“Schneider Electric Solar” means the following Schneider Electric solar entities:

- Schneider Electric Solar Inverters USA, Inc.

“Distributor” means any Schneider Electric Solar-approved retailer, reseller or distributor of the Product which may include a Schneider Electric entity other than the Schneider Electric Solar entities listed above.

“Product” means the Schneider Electric Solar or related branded inverter product (or other related device) as identified above that You purchased from Schneider Electric Solar or through an authorized Distributor.

“You and Your” means the end-customer that has purchased and uses the Product and is entitled to the benefits of this Contractual Warranty.

1. Warranty Period and Coverage

This Contractual Warranty is provided by Schneider Electric Solar and covers defects in workmanship and materials in Your Product. In the event You purchased the Product from a Distributor, this warranty period commences upon the date of shipment from Distributor to You. In the event You purchased the Product directly



Certificación de Equipos de Energía Renovable

Datos de la Solicitud

De acuerdo a la información suministrada se solicita la certificación para equipo(s) de energía renovable Comercial-Privado, en territorio del Estado Libre Asociado de Puerto Rico, según indicado(s) a continuación:

Solicitante: RICARDO R ACEVEDO

Correo Electrónico: racevedo@glenninternational.com

Compañía: Glenn International, Inc.

Datos de Equipo Certificado

Tipo de Equipo(s): Inversor

Clasificación: Equipo Existente

MARCA	MODELO	CERTIFICACIONES	ESPECIFICACIONES
SCHNEIDER	CONEXT XW PRO 6848 NA	Certificación de Seguridad: UL 1741 Núm. Certificación: 70194014 Laboratorio: CSA	Interconectable: SI Voltaje(s) Salida: 240 VAC Voltaje(s) Máximo Entrada: 60 VDC Eficiencia Máxima: 95.0% Tipo de Gabinete(NEMA): NEMA Type 1 Indoor Potencia Nominal: 6800Watts Garantía Manufactura: 5 año(s)

JDPF
JDPF

División de Edificabilidad

~~WOPR~~
WOPR Se recomienda la instalación del equipo de fuente de energía renovable sometido ante la OGP, a tenor con el Reglamento para la Certificación de Sistemas de Energía Renovable y el Reglamento Conjunto para Obras de Construcción y Usos de Terrenos, vigentes.

Condiciones Especiales

Bajo ninguna circunstancia, deberá interpretar que esta certificación implique la aprobación de instalación de equipos en un proyecto de construcción, ni que se autorice iniciar obras de construcción de clase alguna, sin el trámite del correspondientes permiso de construcción.

Firmas / Sellos

Fecha de Expedición:

03/SEP/2020



Ing. Gabriel Hernández Rodríguez
Secretario Auxiliar



FORTRESS *Power eFlex*

eFlex 5.4 Lithium Battery Storage

Energy Savings & Security with Fortress Power



Maximize Your Solar Investment with Battery Storage



Achieve Grid Independence during Power Outages



Reduce Your Electric Bill



Versatile Applications including Home, Business,
Mobile, Telecom and Railway

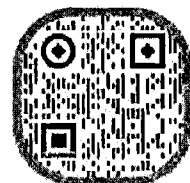
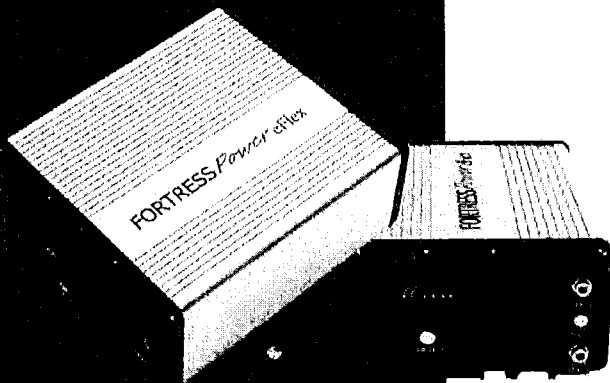

SCAN FOR
INSTALLATION
MANUAL

eFlex 5.4 kWh Solar Storage Battery

Taking Innovation to the Next Level

Safest Lithium Technology (LiFeP04) on the market

MODbus and CANbus Communication for Internet-of-Things Copatibility

98% Roundtrip Efficiency

IP65 Dust and Water Proof Design

10 Year Warranty with Unlimited Partial Cycles

Data communication with popular hybrid inverters

Market Leading BMS Battery to Maximize Reliability and Longevity

JDPF
JDPF

WORR
WORR

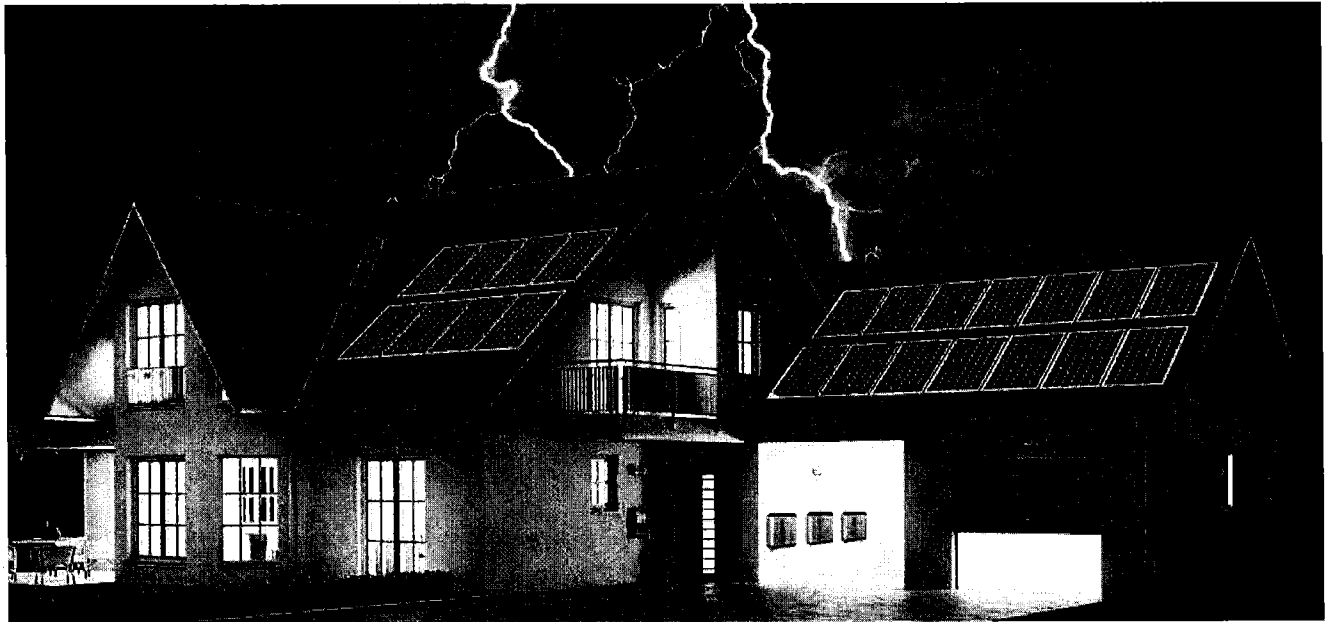

"Few companies offer such support at all these levels"

"Fortress Power has been fantastic to work with. Their technical team is readily available for installation questions. Their shipping team keeps me informed of the timing of deliveries. The sales department makes sure we know about sale prices, new products, and their terrific discount for veterans. Few companies offer such support at all these levels. A super team to work with! "

- Lori Hunt
Practical Preppers LLC

Versatile Applications

Designed For Multiple Project Scenarios

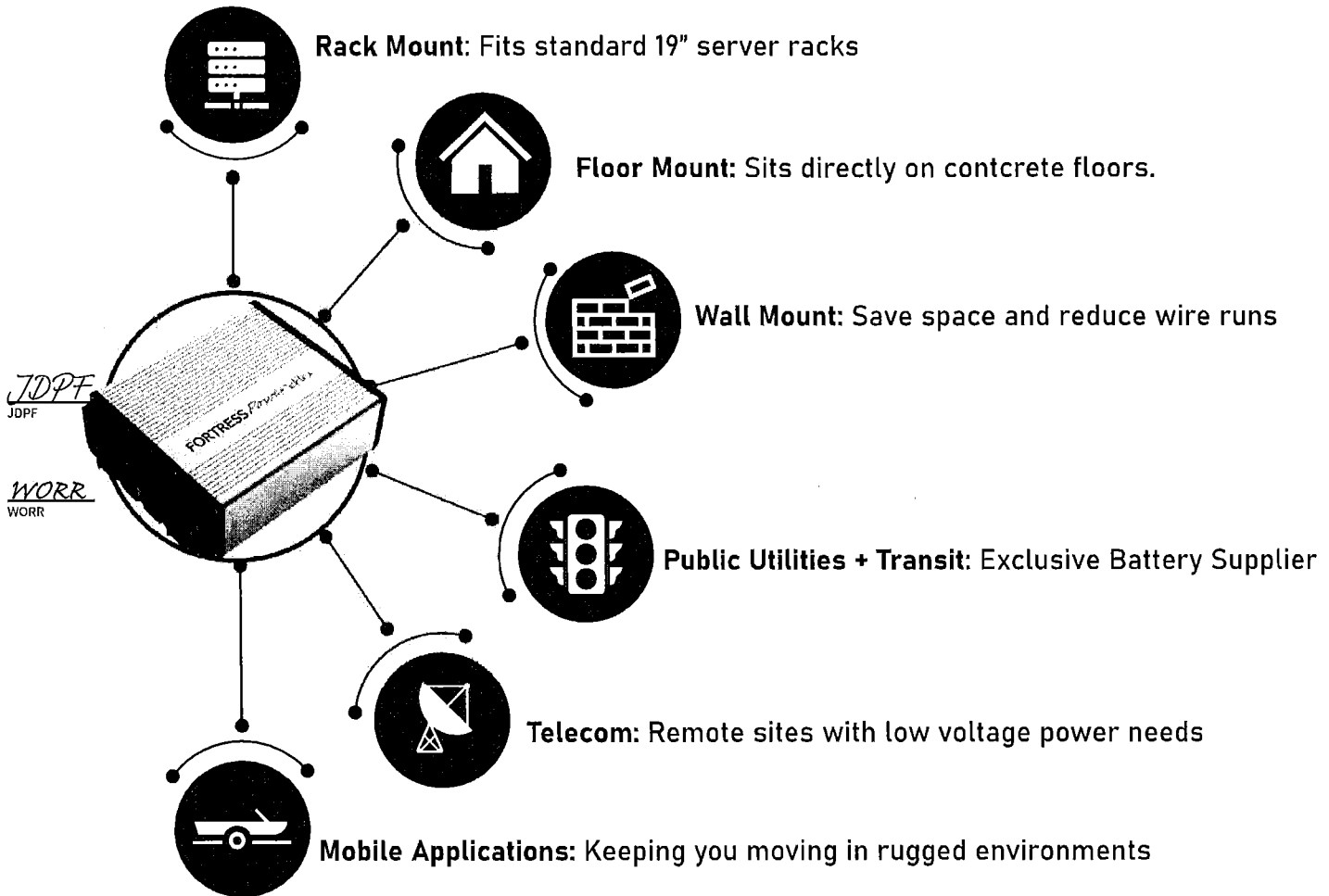

"You Think It - We'll Power It"

**INTERESTED IN BECOMING A
CERTIFIED INSTALLER?**

Join us to bring the latest energystorages to millions of homes and businesses across the world!

SCAN ME

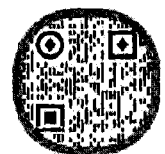

eFlex 5.4 kWh Lithium Storage

	eFlex 5.4
Total Energy (kWh)	5.4
Max. Charge Current (Continuous) [A]	100
Max. Discharge Current (Continuous) [A]	60
Max. Pulse Current (for 5sec) [A]	130
Capacity [Ah]	105
Voltage Range [V]	44-58.4
Charging Temperature [F]	32 to 113
Discharging Temperature [F]	32 to 140
Storage Temperature [F]	32 to 95
Dimension [LxWxH, Inch]	21.5 x 17.5 x 7.2
Weight [lbs]	116
Life Cycles	6000 @ 80% DoD
Round Trip Efficiency	>98%

Compatible with Most
Inverters on the Market

Schneider Sol-Ark MidNite Solar OutBack Power SMA Morningstar

ABOUT FORTRESS POWER

Fortress Power proudly services homes, businesses, utilities, telecom and transportation companies worldwide. Our Pennsylvania-based team's passion for clean energy storage has earned us a place among the world's top energy storage battery manufacturers.

Our logistics centers in California, Florida and Pennsylvania offer easy distribution to all of our major markets. Fortress Power's high-performance solar lithium battery storage products are designed, engineered and inventoried along with live technical support in the United States.

Fortress Power has partnered with industry leading lending institutions to help make your solar investment as easy as possible. Please visit our website for purchasing and financing options.



Fortress Power is a manufacturer of high-performance solar lithium battery storage products that are designed, engineered and inventoried along with live technical support in the United States!

FORTRESS *Power eFlex*



SECURING YOUR ENERGY

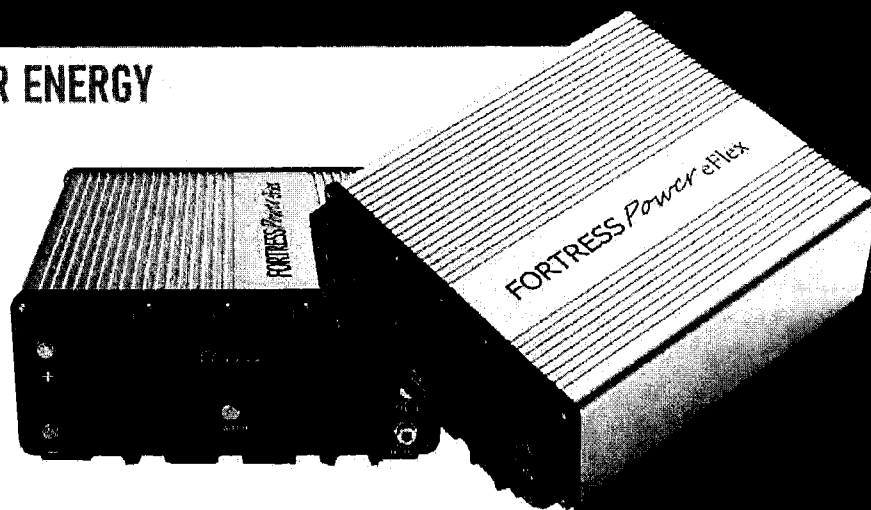

Fortress Power

 505 Keystone Rd. Southampton PA 18966 USA

 www.fortresspower.com

 sales@fortresspower.com

 877-497-6937

eFLEX 5.4

LITHIUM IRON PHOSPHATE BATTERY

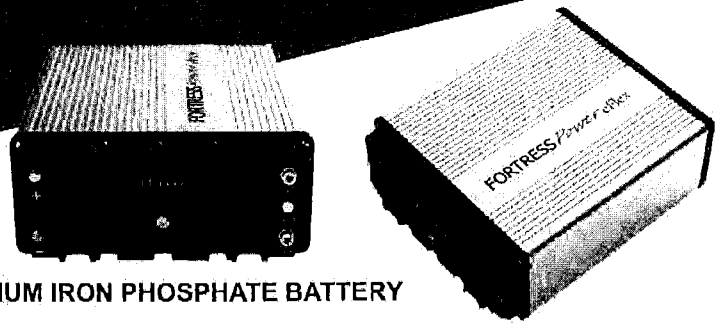

The Fortress Power eFlex is a 5.4 kWh scalable energy storage solution based on safe and energy dense prismatic Lithium Iron Phosphate cells. The digital processor Battery Management System (BMS) includes high amperage contactor disconnects and advanced Closed-Loop inverter communication, as well as individual cell voltage monitoring, temperature monitoring, and cell balancing to maximize reliability and longevity. Canbus, modbus, and wifi communication enable internet-of-things compatibility. The IP65 case ensures direct water spray and dust will not penetrate the battery internals from all directions. The unit can be wall mounted, floor mounted, and server rack mounted for hard-to-reach access in renewable, marine, RV, mobile, telecom, railway applications and more!

- 98% Roundtrip efficiency
- High Durability and Long-Lasting
- Safe Lithium Iron Phosphate Technology (LiFePO4)
- Flexible mounting options
- Data communication with popular hybrid inverters
- Remote monitoring
- Advanced cell level monitoring and balancing
- Integrated heat sink for 5x better thermal performance

JDPF
JDPF

WORR
WORR

Electrical Specifications	
Nominal Voltage:	51.2V
Nominal Capacity:	105AH
Rated Capacity @ 0.5C (50A):	5.374 kWh
Resistance:	<10 mΩ
Efficiency (at 0.5C):	98%
Self-Discharge:	<1 % / Month
Maximum Allowed Modules in Parallel:	15

Charge Specifications	
Recommended Charge Current:	<55A
Maximum Charge Current:	100A
Recommended Charge Voltage:	54.4V
BMS Charge Voltage Disconnect:	>56V

Discharge Specifications	
Recommended Continuous Discharge Rate:	60A (3KW DC)
Peak Continuous Discharge Rate:	100A (5 KW 60 Min)
Maximum Surge Power Rate:	130A (6.6 KW 5S)
Recommended Low Voltage Disconnect:	48V
Battery Low Voltage Protection:	<45V
Battery recovery Voltage:	45V

Temperature Specifications	
Discharge Temperature:	-4°F ~ 131°F (-20°C ~ 55°C)
Charge Temperature:	32°F ~ 114°F (0°C ~ 45°C)
Storage Temperature:	20°F ~ 95°F (-6°C ~ 35°C)

Mechanical Specifications	
Dimensions: (L*W*H)	21.5 x 23 x 17.5 x 7.3 inches 546 x 446 x 183 mm
Weight:	108 lbs (49kg)
Terminal Type:	M8
Ring Terminal Size:	3/8ths or larger
Terminal Torque:	7.0 – 7.7 Nm (5.1 – 5.7 ft-lb)
Case Material:	Anodized Aluminum
Enclosure Protection:	IP65
Cell Type Chemistry:	Prismatic - LiFePO4

Compliance Specifications:	
Certifications:	UL1973, UL1642
Shipping Classification:	UN 38.3 CLASS 9

Basic Charging Profile	
Bulk + Absorb Charge	54.4V
Absorb Time	60 minutes
Float Charge	54V
Inverter Charging	2 Stage / No Float
Equalization	No equalization (typical) 54.6V for 10 seconds (rare)
Temperature Compensation	None

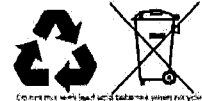

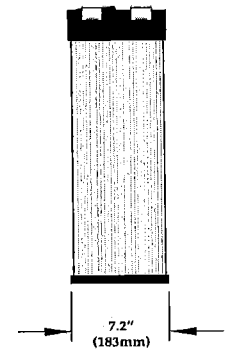
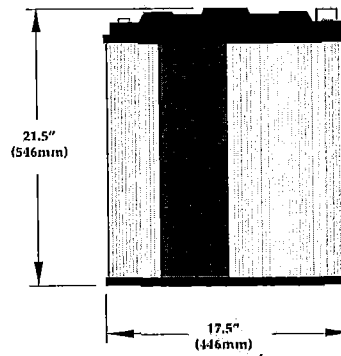
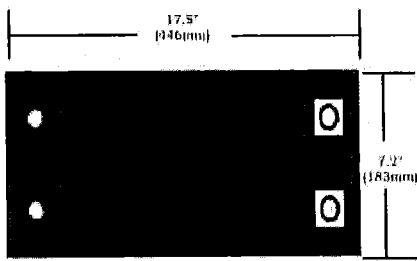

Accessories (Not Included)

Wall Mount Kit

Wall Mount Bracket

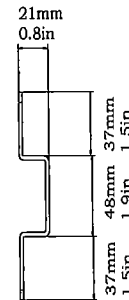
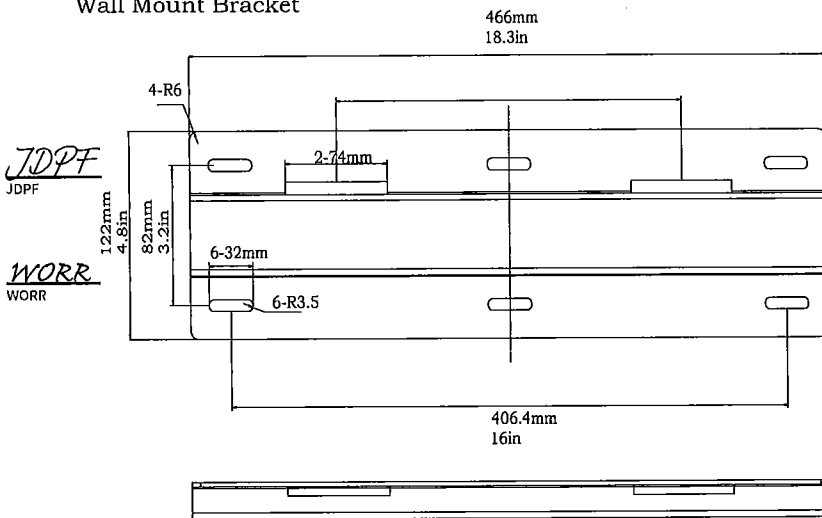

Wall Mount Hook

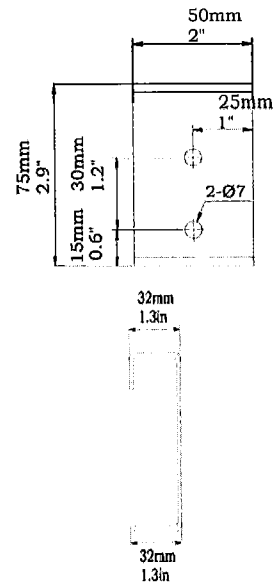

Server Rack Mount Kit

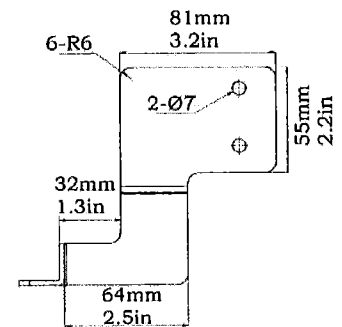
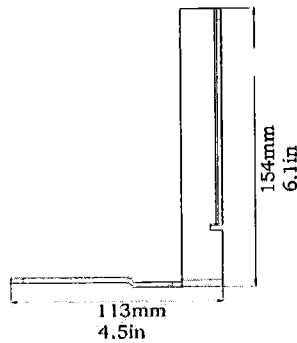
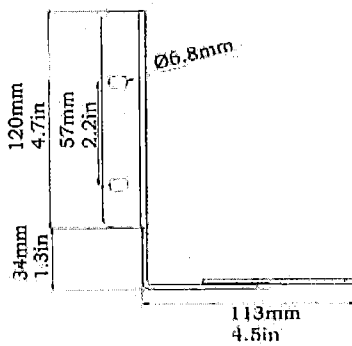

Scan for
Installation
Manual:





Tilt Mount System

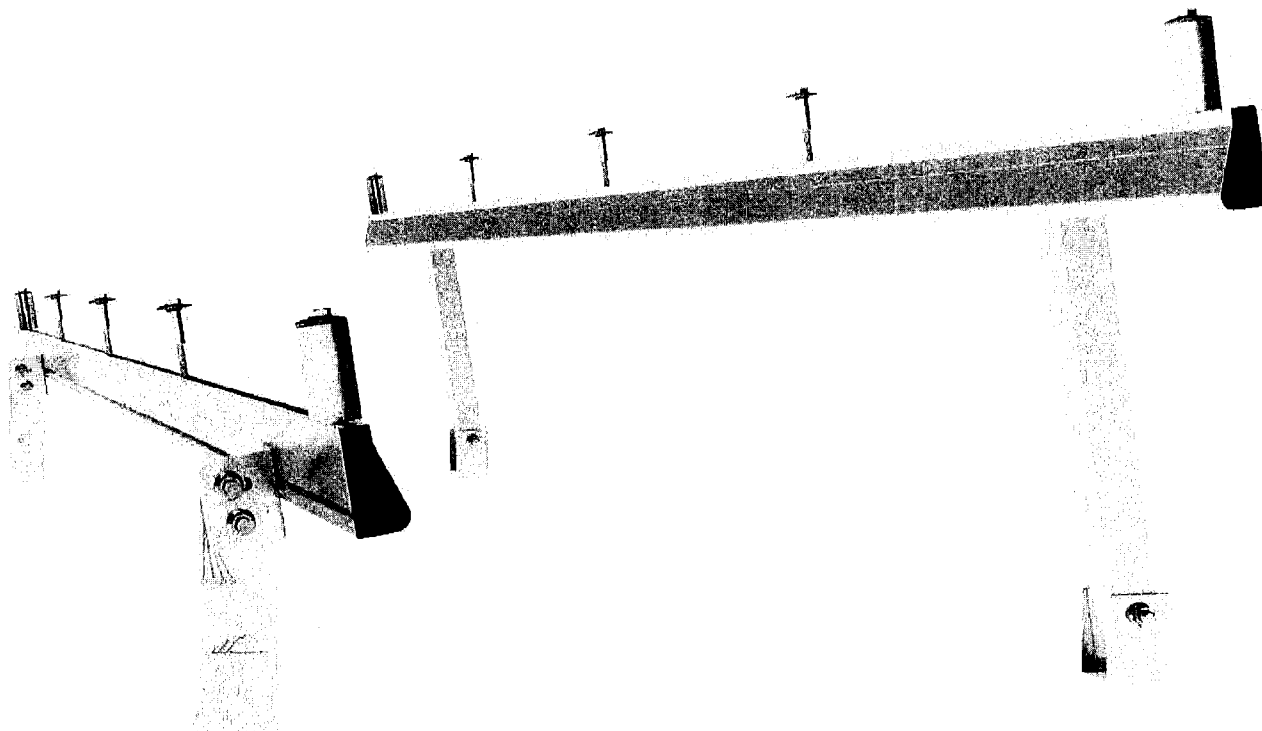

JOPF
JOPF

WORR
WORR

Trust your system at every angle.

The IronRidge Tilt Mount System supports a wide range of solar module tilting angles, while also resisting the extreme wind and snow forces experienced over a building's lifetime.

Every component has been carefully engineered and rigorously tested, and the entire system uses only aluminum and stainless steel materials to resist corrosion.



Roof Friendly

Lightweight and compatible with industry-standard attachments.



PE Certified

Pre-stamped engineering letters available in most states.



Strength Tested

All components evaluated for superior structural performance.



Design Assistant

Online software makes it simple to create, share, and price projects.



UL 2703 Listed System

Meets newest effective UL 2703 standard.



25-Year Warranty

Products guaranteed to be free of impairing defects.

XR Rails & Tilt Legs

XR Rails

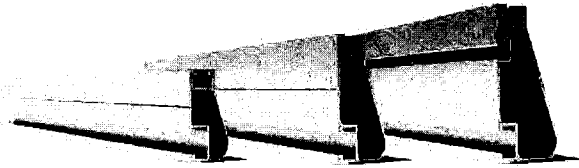

Attach directly to Tilt Legs. Available in three targeted sizes to support specific wind and snow loads.

- Unique curved profile
- Spanning capabilities up to 12'
- Clear and black finish

Tilt Legs ☺

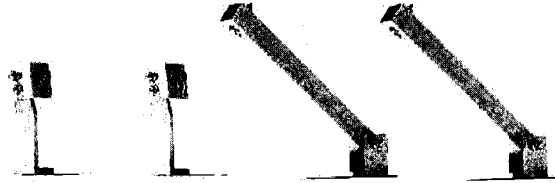

Tilt assembly to desired angle, up to 30 degrees. Kits include South and North Tilt Leg and all hardware.

- Available in multiple lengths for a wide angle range
- Assembled South Tilt Legs include angle indicators
- Legs are electrically bonded to rails

Clamps & Grounding

UFOs ☺

JDPF
JDPF



WORR
WORR

Universal Fastening Objects secure and bond modules to rails.

- Fully assembled and lubricated
- Single, universal size
- Clear and black finish

Stopper Sleeves ☺



Snap onto the UFO to transform into a bonded end clamp.

- Bonds modules to rails
- Sized to match modules
- Clear and black finish

Grounding Lugs ☺



Connects Tilt Mount system to equipment ground.

- Low profile
- Single tool installation
- Mounts in any direction

Accessories

Bonded Splices ☺

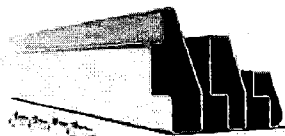

XR Rails use internal splices for seamless connections.

- Self-drilling screws
- Varying versions to match rails
- Forms secure bonding connection

End Caps



Provide a finished look for rails while preventing debris buildup.

- Easy snap-in installation
- Varying versions to match rails
- UV-stabilized polymer

Wire Clips



Organize electrical wires from the rail's top slot.

- Simple snap-in installation
- Holds up to ten 5mm wires
- UV-stabilized polymer

Resources

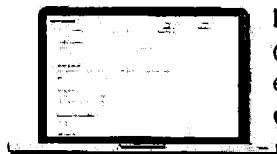

Design Assistant

Go from rough layout to fully engineered system. For free. Go to IronRidge.com/design



NABCEP Certified Training

Earn free continuing education credits, while learning more about our systems. Go to IronRidge.com/training

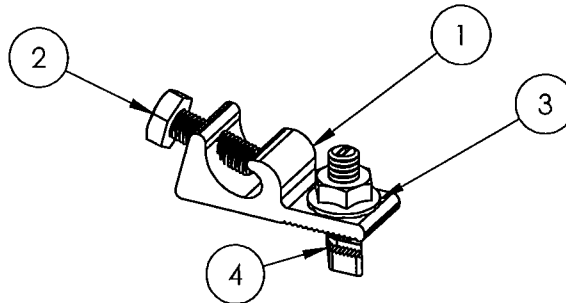

ITEM NO.	DESCRIPTION	QTY. IN KIT
1	LUG, GROUNDING, LAY-IN - LOW PROFILE	2
2	BOLT, 1/4-28 X .750" HEX CS SST	2
3	NUT, FLANGE HEX 1/4-20 SST	2
4	BOLT, T CSTM 1/4-20 X 1.188" LOCK SS	2

Part Number	Description	Wire Size Range (AWG)
GD-LUG-003	KIT, 2PCS, GROUNDING LUG, LOW PROFILE	4-10

JDPF
JDPF

WRR
WRR

1) Lug, Grounding

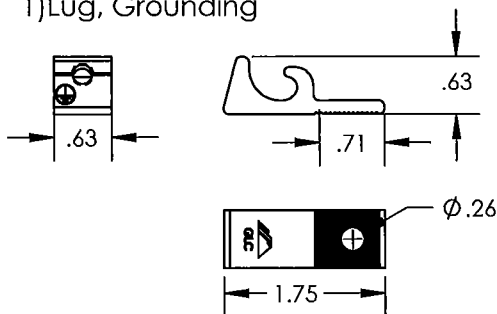

Property	Value
Material	Tin Plated Copper
Finish	Clear Matte

3) Nut, Flange Hex 1/4-20

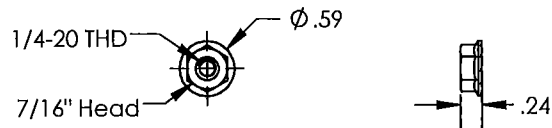

Property	Value
Material	300 Series Stainless Steel
Finish	Clear

2) Bolt, 1/4-28 x .750 Hex

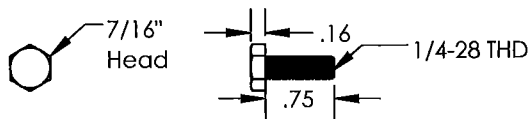

Property	Value
Material	300 Series Stainless Steel
Finish	Clear

4) Bolt, T CSTM 1/4-20 x .750

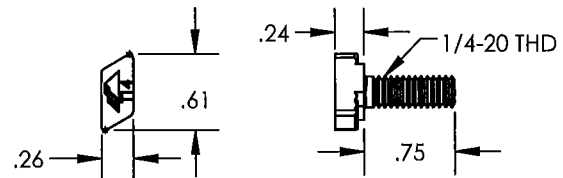

Property	Value
Material	300 Series Stainless Steel
Finish	Clear

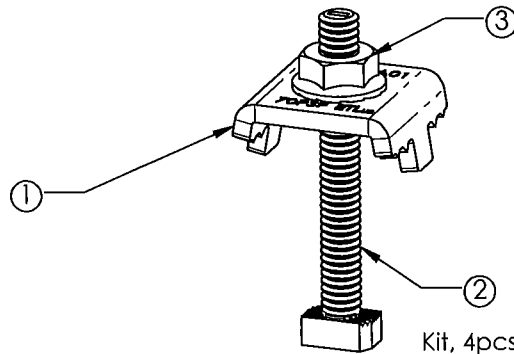

Kit, 4pcs, Grounding Mid Clamp

Item Number	Component	Qty in Kit
1	Clamp, Grounding Mid	4
2	Bolt, T Cstm 1/4-20	4
3	Nut, Flange Hex 1/4-20 SST	4

JDPF
JDFF

Kit, 4pcs, Grounding Mid Clamp

WORR
WORR

Clear Part Number	Black Part Number	Description / Length	Bolt Length
RS-GD-MCL-200	RS-GD-MCL-200B	Kit, 4pcs, Grounding Mid Clamp 2.00"	2.00"
RS-GD-MCL-225	RS-GD-MCL-225B	Kit, 4pcs, Grounding Mid Clamp 2.25"	2.25"
RS-GD-MCL-250	RS-GD-MCL-250B	Kit, 4pcs, Grounding Mid Clamp 2.50"	2.50"
RS-GD-MCL-275	RS-GD-MCL-275B	Kit, 4pcs, Grounding Mid Clamp 2.75"	2.75"

1) Integrated Grounding Mid Clamp

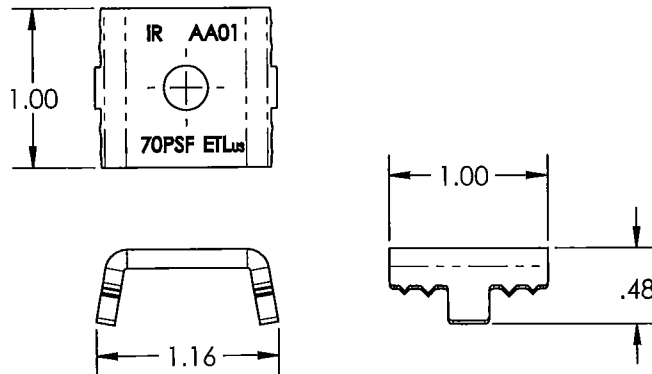

Property	Value
Material	300 Series Stainless Steel
Finish	CLEAR

2) Bolt, T Cstm 1/4-20

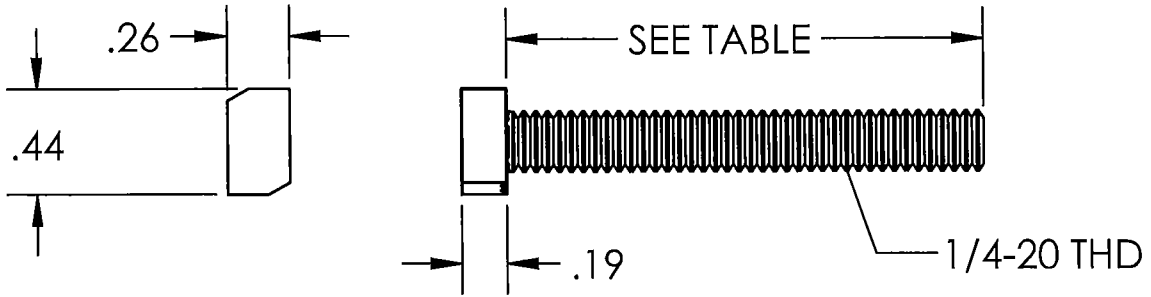

Property	Value
Material	300 Series Stainless Steel
Finish	Clear

JDPF
JDPF

WRR
WRR

3) Nut, Flange Hex 1/4-20 SST

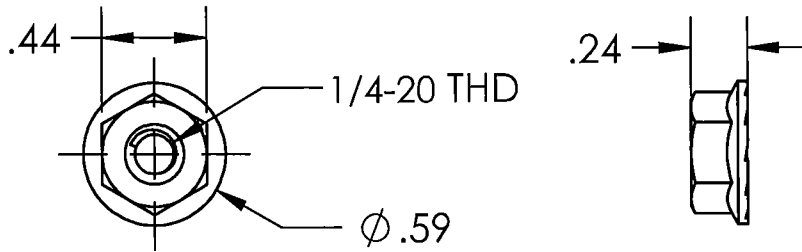

Property	Value
Material	300 Series Stainless Steel
Finish	Clear

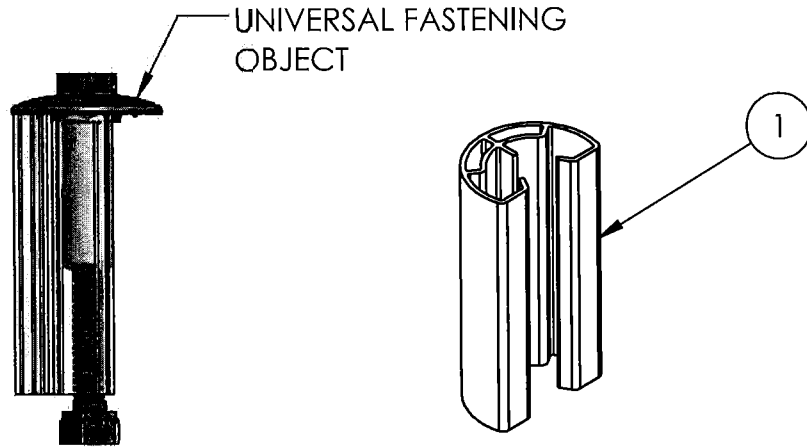

JDPF
JDPF

ITEM NO.	COMPONENT	QTY. IN KIT
1	STOPPER SLEEVE	4

WORR
WORR

TABLE 1: STOPPER SLEEVE PART NUMBERS AND HEIGHT

MILL PART NUMBER	BLACK PART NUMBER	HEIGHT "X" (mm)
UFO-STP-30 mm	UFO-STP-30 mm-B	30
UFO-STP-32 mm	UFO-STP-32 mm-B	32
UFO-STP-33 mm	UFO-STP-33 mm-B	Sticky Note 3 IR7XP8CT1 Replace with 5 UFO-STP-30MM-M1 UFO-STP-32MM-M1 UFO-STP-33MM-M1 UFO-STP-35MM-M1 UFO-STP-38MM-M1 UFO-STP-40MM-M1 UFO-STP-42MM-M1 UFO-STP-46MM-M1
UFO-STP-35 mm	UFO-STP-35 mm-B	
UFO-STP-38 mm	UFO-STP-38 mm-B	
UFO-STP-40 mm	UFO-STP-40 mm-B	
UFO-STP-42 mm	UFO-STP-42 mm-B	
UFO-STP-46 mm	UFO-STP-46 mm-B	

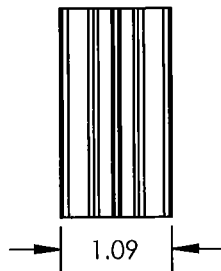
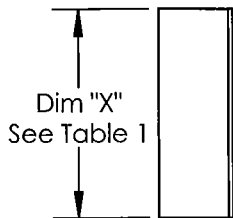
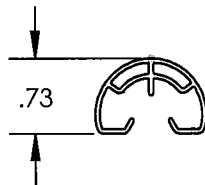

Property	Value
Material	6000 Series Aluminum
Finish	Mill or Black

JDPF
JDPF

WOPR
WOPR

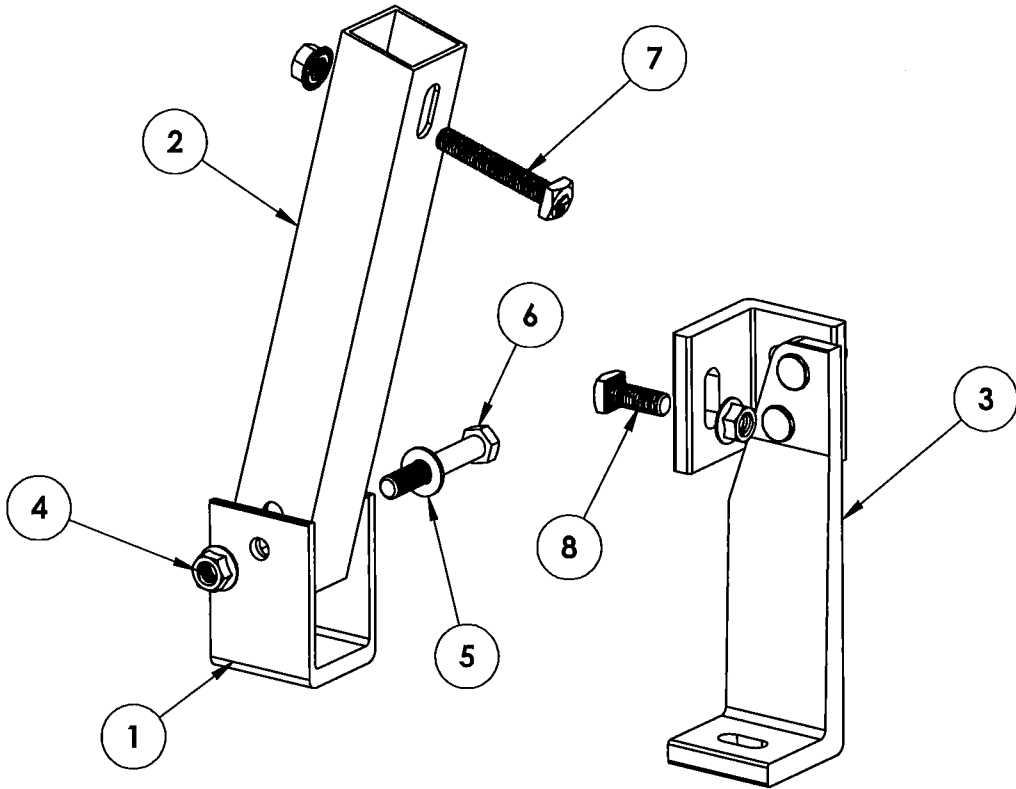

ITEM NO.	DESCRIPTION	QTY.
1	U-FOOT	1
2	NORTH TILT LEG, 1.5" SQ, LENGTH VARIES	1
3	PRE-ASSEMBLED SOUTH TILT LEG	1
4	NUT, FLANGE HEX 3/8-16 SS	3
5	WASHER, FLAT 3/8 SS	1
6	BOLT, 3/8-16 X 2.5" CS SST	1
7	BOLT, BONDING 3/8-16 SQ HEAD, 2.25"	1
8	BOLT, BONDING 3/8-16 SQ HEAD, 1.0"	1

Part Number	Description	North Tilt Leg Length
TM-FTL-007	Kit, Fixed Tilt Leg, 7", Mill	7"
TM-FTL-010	Kit, Fixed Tilt Leg, 10", Mill	10"
TM-FTL-015	Kit, Fixed Tilt Leg, 15", Mill	15"
TM-FTL-020	Kit, Fixed Tilt Leg, 20", Mill	20"
TM-FTL-025	Kit, Fixed Tilt Leg, 25", Mill	25"
TM-FTL-030	Kit, Fixed Tilt Leg, 30", Mill	30"

1) U-Foot

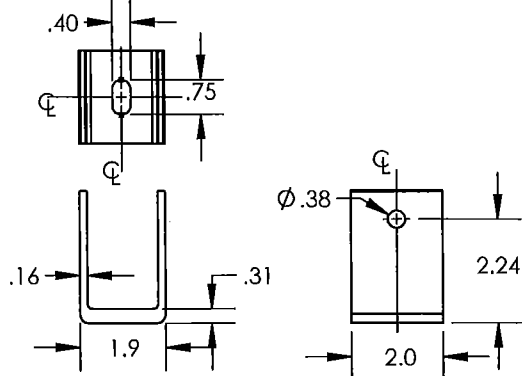

Property	Value
Material	Aluminum
Finish	Mill

4) Nut, Flange Hex 3/8-16 SS

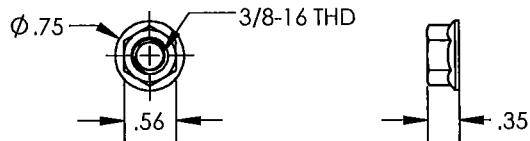

Property	Value
Material	Stainless Steel
Finish	Clear

5) Washer, Flat 3/8 SS

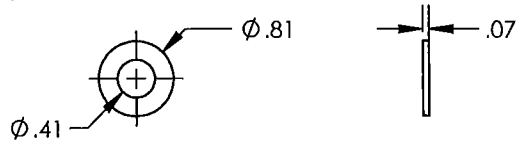

Property	Value
Material	Stainless Steel
Finish	Clear

2) North Tilt Leg

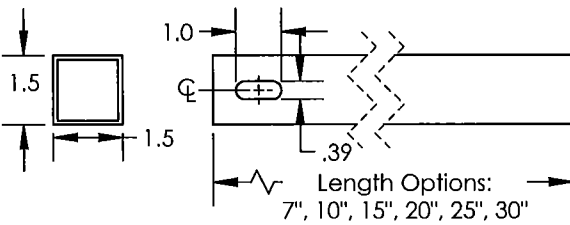

Property	Value
Material	Aluminum
Finish	Mill

6) Bolt, 3/8-16 X 2.5" CS SS

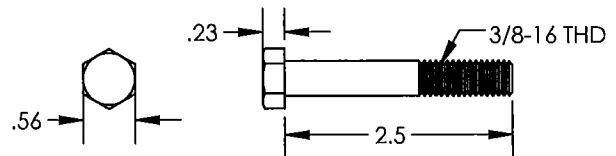

Property	Value
Material	Stainless Steel
Finish	Clear

3) Pre-assembled South Tilt Leg

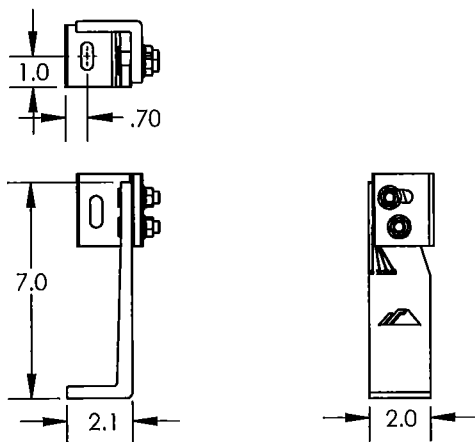

Property	Value
Material	Aluminum
Finish	Mill

7, 8) Bolt, Bonding 3/8-16 Sq Head

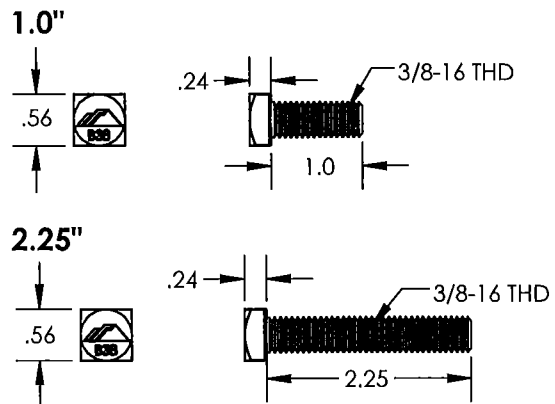

Property	Value
Material	Stainless Steel
Finish	Clear

JDPF

WORR



Universal Fastening Object

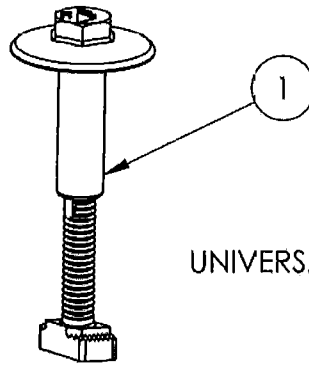

UNIVERSAL FASTENING OBJECT

JDPF
JDPF

WORR
WORR

ITEM NO.	DESCRIPTION	QTY. IN KIT
UFO-CL-001	KIT, 4PCS, UNIVERSAL MODULE CLAMP, CLEAR	4
UFO-CL-001-B	KIT, 4PCS, UNIVERSAL MODULE CLAMP, BLACK	4

Sticky Note IR7XP8CT1

Update item number to "UFO-CL-01-B1" and description to "Universal Module Clamp, Black". Remove qty column.

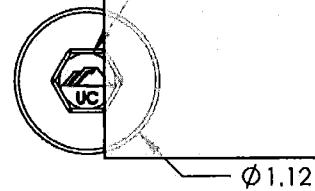
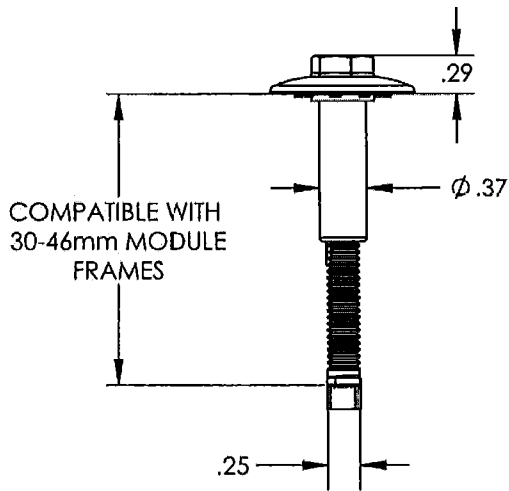

Property	Value
Material	300 Series Stainless Steel
Finish	Clear and Black

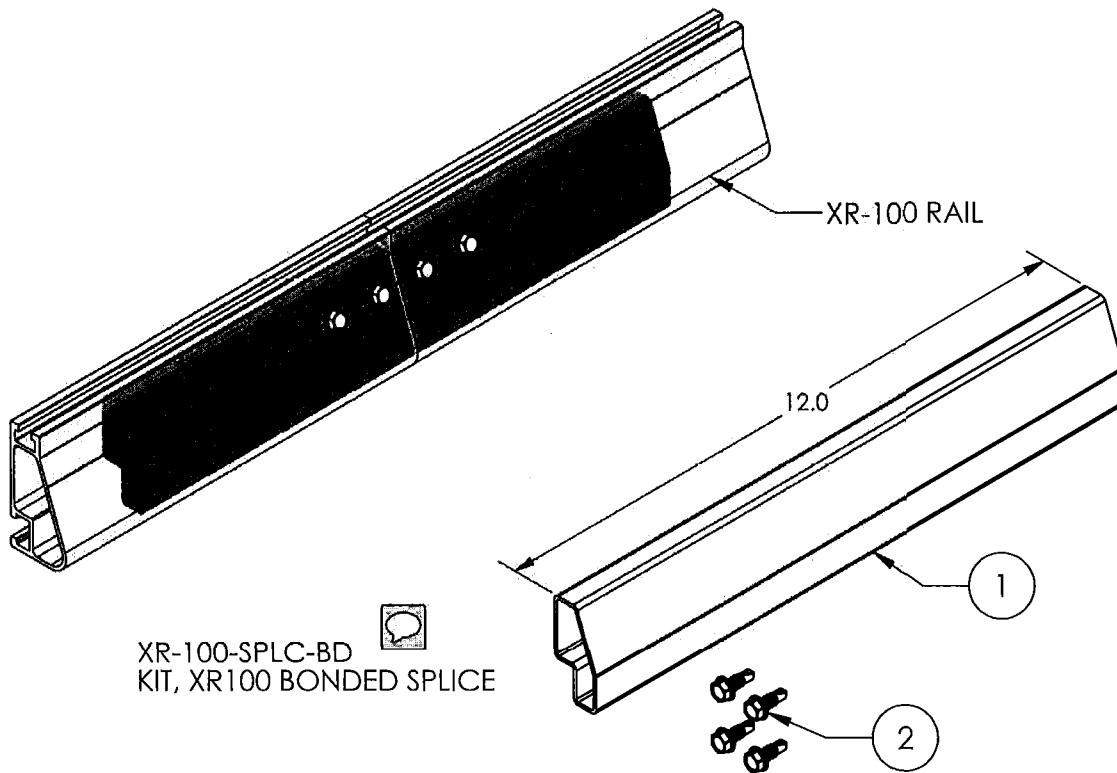

JDPF
JDPF

WORR
WORR

1) Splice, XR100, Mill 12" long

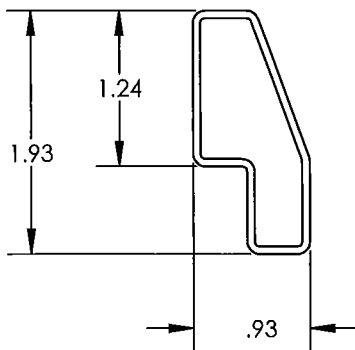

Property	Value
Material	6000 Series Aluminum
Finish	Mill

2) Screw, Self Drilling

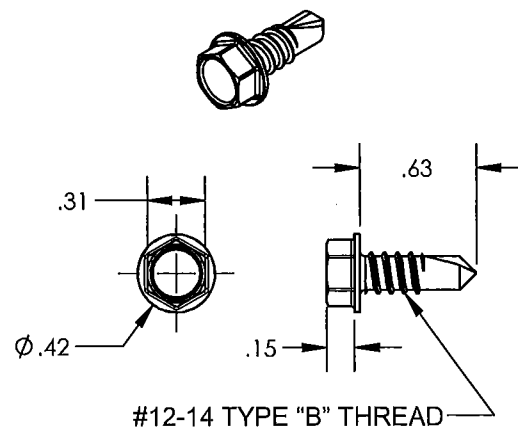

Property	Value
Material	300 Series Stainless Steel
Finish	Clear



GOVERNMENT OF PUERTO RICO
DEPARTMENT OF HOUSING

SCOPE OF WORK
Invitation for Bid
Increase Capacity
PV Systems, Water Storage System Acquisition, and Installation Services
Community Development Block Grant – Disaster Recovery
Puerto Rico Department of Housing
CDBG-DR-IFB-2022-03

1. Introduction

The Puerto Rico Department of Housing solicits the bids for the purchase of PV Systems and Water Storage System and Installation Services for the Community Energy and Water Resilience Installation Program (**CEWRI**) funded by the Community Development Block Grant – Disaster Recovery (**CDBG-DR**) Program. This document defines the work and requirements the Selected Bidder(s) must perform under a contract with PRDOH across a broad range of the CDBG-DR and Community Development Block Grant – Mitigation (**CDBG-MIT**) funded programs. The process is designed to promote fair and open competition while seeking a cost-competitive solution.

A detailed description of CDBG-DR Programs is included in the Action Plan approved by the U.S. Housing and Urban Development (**HUD**). A complete copy of the CDBG-DR Action Plan is available at www.cdbg-dr.pr.gov/action-plan. A complete copy of the CDBG-MIT Action Plan is available at <https://cdbg-dr.pr.gov/en/download/cdbg-mit-action-plan-effective-on-april-19th-2021/>.

Program Overview

The CEWRI Program provides homeowners energy and water efficiency improvements to promote resilience during emergencies with the installation of Photovoltaic System (**PV Systems**) with battery back-up for critical loads and Water Storage System (**WSS**). The CEWRI program also assists homeowners that have been recipients of Rehabilitation, Reconstruction, or New Construction under the Repair, Reconstruction, or Relocation Program (**R3 Program**).

The purchase and installation of PV Systems and WSS are specifically for the homes that have been repaired or reconstructed under the R3 Program. We are defining homes as those involving the construction, alteration, or repair of single-family houses or apartment buildings of no more than four stories in height. Homes that do not fall under this category are not included in this scope of work.

The PRDOH seeks, at its discretion and in the best interest of the program implementation, to award multiple contracts with a two (2) year term of services and an option to extend up to one (1) year. The acquisition of equipment and the required installation services will be made on an as-needed basis and issued on a work order.

No guarantee of the acquisition of any specific quantity or total dollar amount is made. The PRDOH reserves the right to increase or decrease amounts proposed on all goods/services. The PRDOH reserves the right to add or delete goods/services. Proposed

JDPF
JDPF

WORB
WORB

quantities represent a reasonable estimate under this contract for bidding purposes. This IFB should be considered an "all or non-basis". However, Bidders are encouraged to provide a bid for all goods and services listed in this Scope of Work. Bidders must provide bids for equipment and installation of Photovoltaic System PV System and Water Storage System.

The selected Bidder will be directly responsible for ensuring the accuracy, timeliness, and completion of all tasks assigned under this contract. Therefore, we encourage a careful analysis of the requirements of this document. The scope of work represents the present need and circumstances at the time the IFB is released. The selected Bidder must guarantee the prices of all the goods/services for the contract term. The PRDOH reserves the right to modify or delete the tasks/goods listed and, if appropriate, add additional tasks/goods before and during the term of the contract.

2. PRDOH's Reservation of Rights

The PRDOH reserves the right, without limitations, to:

- (i) Reject any or all bids, to waive any informality in the IFB process, or to terminate the IFB process at any time, if deemed by to be in its best interests.
- (ii) Reject and not consider any bid that does not meet the requirements of this IFB, including but not necessarily limited to incomplete bids and/or bids offering alternate or non-requested services.
- (iii) Cancel this solicitation and reissue the IFB or another version of it, if it deems that doing so is in the best interest of the Public Interest.
- (iv) PRDOH shall have no obligation to compensate any bidder for any costs incurred in responding to this IFB.
- (v) To reduce or increase estimated or actual quantities in whatever amount necessary without prejudice or liability to, if:
 - a. Funding is not available,
 - b. Legal restrictions are placed upon the expenditure of monies for this category.
 - c. PRDOH's requirements in good faith change after award of the contract.
- (vi) Make an award to more than one bidder based on ratings.
- (vii) To require additional information from all bidders to determine level of responsibility.
- (viii) To contact any individuals, entities, or organizations that have had a business relationship with the proposer regardless of their inclusion in the reference section of the proposal submittal.
- (ix) In the event any resulting contract is prematurely terminated due to nonperformance and/or withdrawal by the Contractor, PRDOH reserves the right to:
 - a. seek monetary restitution (to include but not limited to withholding of monies owed) from the Contractor to cover costs for interim services and/or cover the difference of a higher cost (difference between terminated Contractor's rate and new company's rate) beginning the date of Contractor's termination through the contract expiration date.

JDPF
JDPF

WORR
WORR

- (x) Amend the contract(s) of the Selected Bidder(s) to, among others, extend its original duration, as further explained in the IFB, or to extend the scale of its scope to include work under subsequent CDBG-DR and CDBG-MIT action plans as related to the services requested herein, or to reduce the scale of its scope to decrease work as a consequence of underperformance or inexcusable delays related to the services requested herein.
- (xi) To contract with one or more qualified bidders as result of the selection of qualified Proposers or the cancellation of this IFB.

3. Requirements

3.1. General Requirements:

- The Bidder selected to provide services regarding Photovoltaic System (**PV System**) must have a minimum of 5 years of experience within the renewable energy sector.
- The Bidder selected to provide services regarding Water Storage System (**WSS**) must have a minimum of 2 years of experience in the installation of WSS.
- The Bidders offering services under this IFB must satisfy both conditions above. All equipment to be supplied and installed by the selected Bidder shall be new, no reconditioned, refurbished, or otherwise used parts or components will be accepted.
- All technical support or any warranty servicing from the manufacturers shall be generated and managed by the selected Bidder once contracted by the PRDOH.
- The selected Bidder shall not provide equipment that is close to the end of life or may become unsupported by the manufacturer during the required warranty period. If any equipment becomes unsupported by the manufacturer, the Bidder will be obligated to replace the equipment with an equivalent that meets the applicable warranty period, with similar or better specifications of the original, without incurring any additional financial obligation from PRDOH.
- All prices submitted by the Bidder shall include all expenses including incidentals, taxes, delivery fees, installation fees, profits, overhead, and any other administrative fees that apply to this acquisition. The PRDOH will not cover any additional costs. Only the unit price submitted for the equipment and installation services will be taken into consideration.
- The PRDOH will not be responsible for reimbursement or expense related to per-diem, tolls, parts or labors for equipment under warranty service.

3.2. Code Compliance:

- Installation and equipment shall comply with applicable building, mechanical, fire, seismic, structural, and electrical codes, included in the Joint Regulation for the Evaluation and Grant of Permits Related to Developments, Land Use, and Business Operations (**Joint Regulation**), as amended. Bidders must abide

JDPF
JDPF

WRR
WRR

by the "Joint Regulation", as amended, "Regulation No. 7796", "Regulation No. 8080," and any other State regulation that regulates the installations within this Program.

- Bidder must install solar system equipment in compliance with Puerto Rico Residential Code 2018 (**PRRC**), National Electric Code (**NEC**), Puerto Rico Electrical Power Authority (**PREPA**) and Permit Management Office (**OGPe**, for its Spanish acronym) Regulations.

3.3. Contractor Responsibilities:

3.3.1. Contractor Levels

Bidders are required to demonstrate financial resources and meet a Line of Credit or Cash availability requirement as outlined in the Invitation for Bid under Section 6.1.8. Based on the information provided and financial capacity demonstrated, the bidders will be categorized Level 1 Contractor or Level 2 Contractor.

Level 1 Contractor:

- Level 1 Contractors must demonstrate and meet the financial capacity requirement as outlined in Section 6.1.8.3, entitled "Line of Credit or Cash Availability";
- Will be frequently evaluated and held responsible for the performance of their team and organization, including designers, consultants, suppliers, manufacturers, and subcontractors;
- Will provide periodical status reports to PRDOH and its representatives; and
- Will attend or conduct meeting with the PRDOH and its representatives.

Level 2 Contractor:

- Level 2 Contractors must demonstrate and meet the financial capacity requirement as outlined in Section 6.1.8.3, entitled "Line of Credit or Cash Availability";
- Will be frequently evaluated and held responsible for the performance of their team and organization, including designers, consultants, suppliers, manufacturers, and subcontractors;
- Will provide periodical status reports to PRDOH and its representatives; and
- Will attend or conduct meeting with the PRDOH and its representatives.

3.4. General Responsibilities:

It is the responsibility of the selected Bidder to deliver quality services in compliance with the project requirements. Also, it is the responsibility of the selected Bidder to:

JDPF
JDPF

WORR
WORR

- Hold the correct permits and licenses necessary to conduct business in Puerto Rico and the city where the project is taking place, and the Bidder must have qualified and licensed personnel as required by the Puerto Rico government to perform PV Systems and/or WSS installations.
- The Designer for the PV Systems must be a licensed engineer in compliance with Puerto Rico's Act Number 173 of August 12, 1988, with the Renewable Solar Energy Installer (Photovoltaic) Certificate from the Public Energy Policy Program (**PEPP**) under the Department of Economic Development and Commerce (**DDEC**, for its Spanish acronym). Must have at least five (5) years of experience performing PV system design. Such designer will also be in charge of the Pre-Installation Assessment.
- PV Systems installers must be a professional with the Renewable Solar Energy Installer (Photovoltaic) Certificate from the Public Energy Policy Program (**PEPP**) under the Department of Economic Development and Commerce (**DDEC**, for its Spanish acronym).
- The Designer for the WSS must be a licensed engineer in compliance with Puerto Rico's Act Number 173 of August 12, 1988. Must have at least two (2) years of experience performing WSS design. Such designer will also be in charge of the Pre-Installation Assessment.
- Uphold a professional demeanor while on a job site.
- Coordinate with PRDOH selected Program Managers (**PMs**) with tasks related to this Scope of Work.
- Coordinate with the selected PM in order to Conduct a Pre-Installation Assessment. This will provide the Designer with the necessary data to perform the design and/or to determine what remediation will be needed for the installation.
- Conduct a pre-award site visit. Assist the PMs during the applicant award process. The Bidder will be responsible for clarifying the owner any design-related clarification that might be needed.
- Perform a Pre-Installation Assessment site visit.
- Perform work after the corresponding reviews, approvals, and or notices to proceed are issued by the selected PRDOH Program Manager.
- Perform work as specified in accordance with all project requirements and all applicable laws and codes.
- Dispose of all materials in a safe manner in accordance with all local and federal regulations.
- Perform commissioning tests and correct any findings. Corrections will be paid by the Bidder, and PRDOH will not reimburse for them.

JDPF
JDPF

WRR
WRR

- Participate in closeout inspections and address findings.
- Work with PMs to ensure the project is completed within the project timeline and budget while minimizing disturbance.

4. Photovoltaic System:

4.1. Pre-Installation Assessment:

The Bidder shall be responsible for the Pre-Installation Assessment of each project site where installation will be performed. A certified installer, a licensed professional engineer, and/or a licensed architect in Puerto Rico with the expertise of five years or more in the Photovoltaic system industry shall conduct the assessment. Assessment includes but is not limited to the following activities:

- Evaluate the property's roof capacity to support the PV system by completing a roof capacity checklist for home installations. The selected bidder will generate a scope of work based on the findings from the roof capacity checklist. A full evaluation shall provide information on roof load capacity, shading study, and other required studies to allow the system to function properly at the installation site. The Scope of Work generated shall detail the installation plan, either on the roof of the dwelling unit to support its installation and full functionality.
- Shading Analysis: Assess if the proposed array location supports a solar resource potential of more than 75 percent of the same site's optimal solar resource potential.
- Assess the home's interior and exterior elements and determine their conditions to facilitate the installation of conduits and electrical equipment. Home interior and exterior elements may include (but is not limited to):
 - Structural, electrical, plumbing, and HVAC systems installed in the roof;
 - Main panelboard
 - Branch circuits
 - Exterior Shade Element
 - Lightning protection
 - Electrical service entry including overhead wires, electric meter, service entry conductor
 - Other relevant components
- After examining the home's roof elements and determine their condition, other considerations may include (but are not limited to) home site elements:
 - Site restrictions
 - Site accessibility
 - Yards and courts

JDPF
JDPF

WORR
WORR

- Structural analysis: Verify the roof's load capacity to support the equipment load, home's exterior elements, and determine their conditions. Home external elements may include (but are not limited to):
 - Roof weatherproofing and covering including asphalt shingles, wood shingles or shakes, metal roofing, cement shingles, built-up roofing, single-ply membranes, and roll roofing, among others;
 - Skylights;
 - Gutters and downspouts; and
 - Parapets and gables.

The structural analysis shall be conducted by a licensed engineer with a structural engineer degree or studies.

- Equipment Location
 - Determine the best locations for the PV System and all components as per designer and manufacturer's specification.
 - In the Pre-Installation Assessment report and Scope of Work, the selected Bidder must clearly define the location of the PV System and all components in accordance with applicable codes.

4.2. Design Service:

- Selected Bidder must design a standard photovoltaic system with battery back-up for single-family homes. System shall be capable of running critical loads, some household appliances (refrigerators, water pump, etc.), life support devices, and permit the occupants to shelter-in-place during electrical grid outages. Design should be standard, with minimal deviation to allow for consistency in cost across various single-family homes. The selected Bidder shall adhere to the following design guidelines:
 - A licensed professional structural engineer must certify that the existing roofs are structurally sound for the installation of the PV System and that the proposed system meets code requirement and the requirement of this IFB.
 - System layout shall meet local fire department, code, and ordinance requirements for roof access.
 - The PV System installation shall not interfere with roof drains, water drainage, expansion joints, air intakes, existing electrical and mechanical equipment, and existing antennas.
 - The system shall be directly attached to the roof unless the structural engineer deems the roof incapable of holding the PV System. If the structural integrity of the house does not support the load of the system, then, the applicant will immediately be ineligible for the PV System installation.
 - Racking Structure needs to be corrosion resistant and meet applicable local building code requirements concerning rain, wind, and earthquake factors.

JDPF
JDPF

WORR
WORR

- All penetrations and structural connections associated with supports and conduit shall be kept to a minimum and shall be waterproof.
- All roof penetrations shall be designed and constructed in collaboration with a roofing professional or manufacturer responsible for the roof and roofing material warranty for the specific site. All roof installations and weatherproofing of penetrations shall not compromise the roof warranty, or if the roof has no warranty, accepted best practice. The roof penetration and roof connections shall be warranted for weather tightness from the installer, including parts and labor (see Section 7 in this document for warranty details). The roofing contractor shall provide a warranty letter specifying that the roofing impermeabilization warranty is still in effect after the installation of the PV System.

4.3. Award Visit:

Refer to Section 6, Other Tasks applicable for services of PV System and Water Storage System, for additional information.

4.4. Permits

The selected Bidder shall obtain all required permits and licenses for the project. Also, the selected Bidder shall be responsible for any certification and/or notification to the applicable state agencies regarding the services to be provided to each project, including interconnection certifications and fees in accordance with the Act 17 of April 11 of 2019 ("Ley de Política Pública Energética de Puerto Rico"). All fees associated with the permits, notifications, and licenses are the responsibility of the selected Bidder.

Any additional documentation required, or corrections of deficiencies identified by Puerto Rico Electric Power Authority (**PREPA**) or any other permitting agencies, after the certification and notification required by the Program, must be addressed and brought to a conclusion by the Bidder at no additional cost to PRDOH.

4.5. PV System Installation Service:

- Selected Bidder shall be responsible for acquiring all permits and endorsements for system installation, system operation, and system interconnection in accordance with Act 17 -2019 ("Ley de Política Pública Energética de Puerto Rico").
- Installation of PV System- selected Bidder shall supply, install, and commission the PV System. Installation costs shall be standardized to accommodate installation across various types of single-family homes. System shall only be installed at sites with at least an 75% solar access, systems shall not be installed on roofs with significant shading. If the site does not have at least an 75% solar access, then, the applicant will be ineligible for the PV System installation. Inverters and batteries shall be installed in a shaded location and shall not be exposed to direct sun light.
- Install materials following the manufacturer's requirements.

JDPF
JDPF

WORR
WORR

- Provide all labor, materials, tools, equipment, and services required to complete the project as specified.
- Responsible for the cost of all items required for a complete and operating system.
- The selected Bidder shall be obligated to maintain a torque log of the installations, following designers' specifications.
- No material should be installed if:
 - Materials are not compatible with existing conditions.
 - Installation of materials violates equipment warranty.
 - Installation is not to code or industry standard.
 - Such are not in compliance with the conditions established by the program, federal or state regulations or this IFB.
- The PV System installations shall follow the best installation practices described by the National Renewable Energy Laboratory (**NREL**) in the following documents or any other industry related document:
 - Solar Photovoltaic in Severe Weather: Cost Consideration for Storm Hardening PV Systems for Resilience
 - Solar Photovoltaic Systems in Hurricanes and Other Severe Weather

The United States Department of Energy Guidance's mentioned above are included as an attachment to this IFB.

4.6. Commissioning

- Perform commissioning and inspection following the International Electrotechnical Commission (**IEC**) standard IEC 62446, any local or state regulation, program requirements, and correct any finding. The commissioning should verify that the project is performing as per project design.
- The designer shall perform commissioning of the entire PV system. This data shall be used to confirm the proper performance of the PV system. Performance tests shall be conducted at the final commissioning/acceptance testing. A digital copy of the commissioning report must be uploaded into Canopy and/or any other PRDOH management tool. A second system re-commissioning is mandatory at the end of the first year of operation. A re-commissioning report will be provided to PRDOH after the re-commissioning has been performed. In the event of a re-commissioning test failure, the Bidder will be responsible for the corrections, repairs, and proper functioning of the system.

4.7. Inspection

Refer to Section 6, Other Tasks applicable for services of PV System and Water Storage System, for additional information.

JDPF
JDPF

WORB
WORB

4.8. Technical Specifications for PV systems:

- The program offers standard packages for PV systems and battery storage based on the following two scenarios:
 - **Scenario #1:** For dwelling units where an ENERGY STAR refrigerator that consumes 489 kWh/yr or less is present, the following package will be installed. A standard package of a required system minimum of **3kW DC¹** PV modules with a minimum Battery bank voltage of **48V²** and a required battery bank output of a minimum of **9 kWh³** with an **autonomy of 20 hours** for units with Energy Star Refrigerators; loads also includes one medical life support device. The required battery chemistry is Lithium-Ion.
 - **Scenario #2:** For dwelling units where a non-ENERGY STAR refrigerator that consumes 489 kWh/yr or less is present and such refrigerator would not be replaced or the applicants do not wish to replace it with an ENERGY STAR Refrigerator, the following package will be installed. A standard package of a required system minimum of **4.3 kW DC** PV modules with a minimum Battery bank voltage of **48V** and a required battery bank output of a minimum of **12.8 kWh** with an **autonomy of 20 hours** for households with no Energy Star certified Refrigerators; loads also includes one medical life support device. The required battery chemistry is Lithium-Ion.

Both standard packages shall have the capability of supplying electricity to an itemized list of devices, appliances and lighting fixtures identified as critical loads. The system will supply electricity to the critical loads independently as a stand-alone system, with the capability of interconnecting with the grid. For the purpose of the CEWRI Program, the Bidder must submit to PREPA the Interconnection package. Nevertheless, the approval of the Interconnection by PREPA will not be required for the closeout of the case.

- Systems shall be capable of running critical electrical loads, some household appliances and equipment (refrigerators, lighting, water pump, etc.), life support or medical devices, and permit shelter-in-place occupants' ability during electrical grid outages. Design should be standard, with minimal deviation to allow for consistency in cost across various single-family homes. In the event of a power outage, the protected appliances, tank's water pump, medical devices, and any load connected to the PV and battery back-up system will continue to work with no disruptions.
- The selected Bidder shall perform all professional services as necessary to provide applicants with a complete design of the proposed project. The system shall be designed and engineered to maximize the solar energy resource, considering the residents' electrical demand and load patterns, proposed installation site, and available solar resource. After concurrence of a final design by PRDOH's Program Manager, the selected Bidder shall provide

¹ kW stands for kilowatt and DC for direct current.

² V stands for voltage.

³ kWh stands for kilowatt hour.

all necessary materials, equipment, and labor to complete the PV System installation and interconnection with the electrical grid in accordance with Act 17 of April 11 of 2019 ("Ley de Política Pública Energética de Puerto Rico").

- The selected Bidder shall also provide and install a manual transfer switch to allow for system operation in standalone mode.
- The selected Bidder shall also provide to the applicant written instructions and procedures for shutdown and start-up activities for all system components.
- Photovoltaic (**PV**) Modules
 - PV modules shall be a commercial off-the-shelf product, must be OGPe Certified.
 - PV modules shall have a 25-year limited warranty that modules will generate no less than 80 percent of rated output under Standard Test Conditions (**STC**). PV modules that do not satisfy this warranty condition shall be replaced.
 - Modules shall be through-bolted to the underlying racking; top down clamps shall not be used under any circumstances, unless the designer specify the contrary.
 - The PV system shall be physically attached to the building roof and tilted at 5 to 10 degrees to the south.
- Inverter(s)
 - Inverters shall be a commercial off-the-shelf product,
 - The inverter shall have at a minimum the following features:
 - OGPe Certification
 - UL/ETL⁴ listed
 - Peak efficiency of 96 percent or higher
 - Inverter shall have operational indicators of performance and have built-in data acquisition and remote monitoring.
 - Warning labels shall be posted in compliance with local and federal regulations
 - Operating instructions shall be posted on or near the system and on file with facilities operation and maintenance documents.
 - Provide detailed instructions on how to turn of the equipment.
 - The inverter shall be 120/240 V split phase.
 - The inverter must provide a Pure Sine Wave.
- Electrical Wiring
 - Areas where wiring passes through ceilings, walls, or other areas of the residence shall be adequately restored, booted, sealed, and returned to their original condition.

⁴ Acronyms stand for the following respectively: Underwriters Laboratory/Electrical Testing Laboratories

JDPF
JDPF

WORR
WORR

- It is mandatory to include a subpanel for the critical loads served by the PV with battery inverter System.
- Structural Components
 - All structural components shall be non-corrosive (preferably marine stainless steel or aluminum). All hardware shall be marine stainless steel or aluminum. All components shall be designed to obtain a minimum 20-year design life.
 - All connections shall be bolted and torqued to specified value. Under no circumstances shall clamping systems or self-tapping sheet metal screws be used to hold:
 - Underlying structural frame members together
 - Module frame to underlying structural frame member
- Back-Up Storage System
 - The required battery chemistry is Lithium-Ion.
 - The required battery bank voltage is 48 V.

5. Water Storage System (WSS):

5.1. Pre-Installation Assessment"

The designer shall be responsible for the Pre-Installation Assessment of the projects to be performed a service. A certified installer, a licensed professional engineer, and/or licensed architect in Puerto Rico with the expertise of five years or more in the construction industry shall conduct the assessment (except for the load analysis, which must be performed by a licensed professional structural engineer). Such task includes but is not limited to the following activities:

- Evaluate the property's roof's capacity to support the WSS system by completing a roof capacity checklist for home installations. The selected bidder will generate a scope of work based on the findings from the roof capacity checklist. A full evaluation should provide information on roof load capacity and all required analysis to allow the system to function properly at the installation site. The Scope of Work generated shall detail the installation plan, either on the roof of the dwelling unit to support its installation and full functionality.
- Assess if the proposed equipment can be located on the rooftop without interfering with the other equipment mounted and/or to be mounted on it.
- Assess the home's interior and exterior elements and determine their conditions to facilitate the WSS components installation. This assessment should be included within the PV System assessment whenever possible. Home interior and exterior elements may include (but are not limited to):
 - Structural, electrical, plumbing, and Heating, Ventilation, and Air Conditioning (HVAC) systems installed in the roof.
 - Main panelboard

JDPF
JDPF

WRR
WRR

- Any electrical conduit that might interfere with the WSS components installation.
- After examining the home's roof elements and determining their condition, home site elements shall be examined which include (but are not limited to):
 - Site restrictions
 - Site accessibility
 - Yards and courts
- Verify the roof's load capacity to support the equipment load, home's exterior elements, and determine their conditions. Home external elements may include (but are not limited to):
 - Roof weatherproofing and covering including asphalt shingles, wood shingles or shakes, metal roofing, cement shingles, built-up roofing, single-ply membranes, and roll roofing, among others.
 - Skylights
 - Gutters and downspouts
 - Parapets and gables
 - Lightning protection
 - Electrical service entry including overhead wires, electric meter, service entry conductor

5.2. Design Service:

Selected bidder must design the Water Storage System for single-family homes following the requirements stated in Section 4.8 of this Scope of Work (Technical Specifications for the Water Storage System).

5.3. Award Visit:

Refer to Section 6, Other Tasks applicable for services of PV System and Water Storage System, for additional information.

5.4. Water Storage System Installation Services

- Selected Bidder shall be responsible for acquiring all equipment and be responsible for its installation.
- Selected Bidder shall be responsible for all permits and endorsements for system installation (as required).
- Installation of Water Storage System- Selected Bidder shall install the Water Storage System. Installation costs shall be standardized to accommodate installation across various types of single-family homes.
- Install materials following the manufacturer's requirements. The Selected Bidder must coordinate with PV system installers to make sure the water pump is connected to a PV standalone electrical system circuit (as required).

JDPF
JDPF

WORR
WORR

- The water pump shall not shade or otherwise obstruct to the photovoltaic modules.
- Provide all labor, materials, tools, equipment, and services required to complete the project as specified.
- Responsible for the cost of all items required for a complete and operating system.
- No materials shall be installed if:
 - Materials are not compatible with existing conditions.
 - Installation of materials violates equipment warranty.
 - Installation is not to code or industry standard.
 - Materials are not in compliance with the conditions established by the program, federal or state regulation or this IFB.

JDPF
JDPF

WRR
WRR

5.5. Inspection:

Refer to Section 6, Other Tasks applicable for services of PV System and Water Storage System, for additional information.

5.6. Technical Specifications for Water Storage System: The selected Bidder shall obtain all necessary equipment, materials, design, and testing services for the installation of the WSS. The system shall:

- Provide domestic water to the home from the water storage tank using an electric water pump, controls and a diaphragm type pressurized tank to provide back-up water supply to the domestic water line. Tank should be sized to meet water needs of the home by providing an adequate level of pressure without damaging water fixtures. The WSS shall supply each household at least two days of potable water supply during a disaster scenario.
- If the roof structure allows, the water storage tank shall store a maximum capacity of 500 Gallons per household, complete with all its necessary accessories and instrumentation for full functionality of water storage and distribution within the home during a disaster scenario. The capacity of the tank should be defined by the designer according to the household needs. The water storage tank shall be connected to the utility's main water line with a water level control valve and backflow preventer designed to prevent backflow from the water storage tank to the utility main water line. The water storage tank shall have instrumentation to monitor and control pressure and water level.
- The water storage tank shall be located on the rooftop of the home. If the structural integrity of the house does not support the load of any of the applicable water tank size options, then, the applicant will immediately be ineligible for the WSS installation.

- In case the house loses power, the electric pump should be able to work off-grid from the main electrical utility supported by the PV and battery system granted to the applicant from the CEWRI program, when applicable.
- The water storage tank shall be constructed of ultraviolet (UV) and corrosion resistant material, approved for potable water, and have the Food and Drug Administration (FDA) and the National Safety Foundation (NSF) approval.
- Other related material for complete installation should include but is not limited to:
 - Pump: ½ horsepower with pressurized tank
 - Diaphragm type pressurized tank should be sized to provide adequate pressure to meet the water demands of the home.
 - Piping: Only copper piping is authorized. Sediment filter: Should be able to filtrate 10 microns particles.
 - Sensor level: Recommended use whenever possible.
 - Install a Buoy
 - Backflow prevention system to prevent cross-connection between household water system and water main.
 - The water storage tank must be watertight and intended for potable water use.
- All water storage tanks must be specifically manufactured for potable water use in accordance with FDA food-grade specifications, NSF standards, or other nationally recognized standards for potable water. Documentation from the manufacturer stating that tanks are approved for potable water must be available for inspection. Water Storage tanks must be installed according to the manufacturers' specific instructions.
- All water storage tanks must be vented to allow the free flow of air into and out of the tank as the water level inside the cistern changes. The vent opening must be turned down and must be screened with a 24-mesh screen cloth to prevent the entry of insects, birds, and other animals.
- Connect to water utility main to provide continuous flow of water through the water storage tank.
- Before filling and using, the water storage tank and pressure tank must first be cleaned and disinfected.
- Disinfection of the water storage tank and pressure tank after installation is mandatory, and the selected Bidder must follow the manufacturer's recommendation for potable water systems.

JDPF
JDPF

WORR
WORR

6. Other tasks applicable for services of PV System and Water Storage System:

6.1. Pre-Installation Assessment Visit, Report, and Case Work Orders

- Perform a Pre-Installation Assessment visit to each dwelling units and develop the Pre-Installation Assessment report for each case project. Submit report to the PMs for approval.
- Develop case Scope of Work for each project. Submit scope of work to the PMs for approval.

6.2. Award Visit:

The Selected Bidder will perform the following tasks during the award visit including but not limited to:

- Perform award visit with the PMs to each applicant's property to complete the Project Grant Agreement.
- Perform orientation to Applicants of the measures that are being offered and that may be installed in the unit.
- Ensure that the applicant is informed on the process, the works to be performed, and the conditions of the award prior to any work being performed.
- Assist the PMs during the applicant award process. The Bidder will be responsible for clarifying the owner any design-related clarification that might be needed.

6.3. Inspection

The Selected Bidder will visit the project site along with the PRDOH Program Manager and inspect works for overall quality standards. Upon completion of the installation, PM's Inspector will perform an inspection of the physical installation, as well as all paperwork submitted by the selected Bidder. Once on-site, the PM's Inspector shall ensure that all contractually agreed upon work was completed and confirm:

- That the equipment installation is in accordance with the design and installation drawings and specifications.
- That the model of the equipment installed is in accordance with the designer's specifications.
- Quality workmanship of installation.
- A brief review of findings as compared to the initial description of the site, scope of work, any change order(s) and final invoice.
- All warranties are included and active.

During the post-install site inspection, the Inspector will record any corrections to the installation that need to be made by the selected Bidder. If, during the post-installation inspection, the Program finds discrepancies between the work performed and the scope of work, installation standards and/or equipment specifications, the selected Bidder will be responsible, at the selected Bidder's

JDPF
JDPF

WORR
WORR

expense, for bringing the installation into conformance before the selected Bidder is paid. Installation corrections, as noted during final acceptance or the post-installation inspection, shall be performed within ten (10) business days. If the selected Bidder cannot undertake corrective actions within ten (10) business days, the Selected Bidder shall deliver to the PM, in writing, reasons for the delay. PM shall determine validity and allow for a delay no longer than twenty (20) calendar days after validity is determined. Any discrepancies or disagreements between PM and selected Bidder shall be escalated to the adjudicating official within PRDOH.

6.4. Orientation and Training to Applicants

- The Selected Bidder shall perform orientation and training to the Applicants regarding operation and maintenance of the installed systems and equipment.
- Selected Bidder must deliver all applicable Operation and Maintenance Manuals of the installed systems to each Applicant receiving a system along with any other required documents.

6.5. Health and Safety:

The Selected Bidder shall observe and comply with all applicable laws, ordinances, codes, and regulations of governmental agencies, including federal, state, municipal, and local governing bodies having jurisdiction over any or all of the scope of services, including all provisions of the Occupational Safety and Health Act of 1979 as amended, and all other applicable federal, state, municipal and local safety regulations. All services performed by the Selected Bidder must be in accordance with these laws, ordinances, codes, and regulations. The Selected Bidder shall release, defend, indemnify and hold harmless the PRDOH, its officers, agents, volunteers, and employees from all damages, liability, fines, penalties, and consequences from any non-compliance or violation of any laws, ordinances, codes, or regulations. Additionally, the following requirements must be met:

- The Selected Bidder must develop and submit to the PMs a safety plan for approval.
- Provide a statement of how your firm will be prepared to work within the project timeline and on time, ensure conformance with quality control standards, and respond to quality control issues during and after completing the project.
- Develop, monitor, and implement health and safety policies as to ensure that projects follow health and safety laws and regulations, in order to reduce or prevent hazards, dangers, and accidents.
- All roof access points shall be securely locked at the end of each day.
- Suppose a release of hazardous materials or hazardous waste that cannot be controlled occurs connected with this contract's performance. In that case, the Selected Bidder shall immediately notify the appropriate public safety service (police, fire rescue, or emergency medical services), PRDOH Program Director, and project designees. The

JDPF
JDPF

WORR
WORR

Selected Bidder shall not store hazardous materials or hazardous waste without proper permits.

6.6. Damage and Disposal:

The Selected Bidder shall proceed with work in a manner that does not damage existing materials/infrastructure unless otherwise directed by Organization:

- The Selected Bidder shall document pre-existing damage to the materials/infrastructure and report any such damage to the PMs.
- The Selected Bidder shall repair at its expense damage to buildings and equipment caused by this project's work.
- The Selected Bidder shall remove all materials, equipment, and debris immediately upon completion of the project or at the end of each workday (unless the dwelling unit owner agrees to provide storage space).
- The Selected Bidder shall keep access to all areas of the dwelling unit clear.
- The Selected Bidder shall not use on-premises refuse containers for disposal of any material whatsoever without prior approval of CEWRI PMs.
- The Selected Bidder shall protect people and property from damage and debris at all times during the construction process.

6.7. Hazardous Material Clean-Up:

All surfaces and articles contaminated by hazardous materials during this work shall be cleaned in accordance with all applicable laws, codes, and ordinances and be transported safely to the appropriate destruction/servicing facilities. The Selected Bidder shall comply with the regulations to manage hazardous waste as specified in the [applicable state code].

6.8. Reporting

The selected Bidder should be responsible for the creation and submission of the following reports to the CEWRI Program Manager:

- Pre-Installation Assessment Report
- Systems Installation Report
- Project Commissioning Report
- Pre-Inspection Package documentation in support to the requested CEWRI Inspection to ensure that current works performed merit the Final Inspection. If documentation submitted to the Program Manager does not merit a Final Inspection, the Program Manager shall deny the Final Inspection request to the PRDOH PV system and water storage system contractor and state the reasons as to why the CEWRI Inspection was denied.

7. Warranty: Selected Bidder shall warrant all its products for the following period:

- **Ten (10) years** guarantee for the Solar Photovoltaic System Panels.

JDPF
JDPF

WARR
WARR

- **Twenty-five (25) years** of Linear Performance Guarantee for the Solar PV modules.
- **Ten (10) years** guarantee on Battery Bank and inverter.
- **Five (5) years** for the WSS.

Warranties shall include:

- Parts, labor, faulty material, manufacturing defects, defective items, emergency works of the systems and installation costs related to the failure of equipment under warranty (when due to equipment failure during the warranty period during the ten years of operation for PV system and five years of operation for the WSS).
- Repair or replacement of all system components for both systems, including but not limited to faulty material, manufacturing defects, during the warranty period.
- All unscheduled or emergency warranty works must be completed within (7) seven days of notification to Selected Bidder from the homeowner at no additional cost to PRDOH or the homeowner during the warranty period. If the 7-day period is not enough due to equipment shortage, the selected Bidder must provide a written explanation and a copy of the equipment's delivery documents.
- Full warranty documents for all installation shall be submitted to the Applicants and in duplicate to the CEWRI PMs firm.

After full payment for the installation, no further costs will be paid by PRDOH

8. Deliverables: The key deliverables to be provided include, but are not limited to, the following:

- Selected Bidder must submit monthly reports to CEWRI Program Manager and PRDOH. Monthly reports shall be due the fifth (5th) day of each month and shall include:
 - Copies of all notifications from CEWRI PMs
 - Inspection orders placed within previous calendar month and inspection reports, as applicable.
 - Notices to begin the design phase within the previous calendar month
 - Notices of accepted/rejected designs within previous calendar month
 - Locations of all pending and completed tasks within the previous calendar month.
 - Explanation of pending and completed design tasks within the previous calendar month.
 - Explanation of pending and completed installation tasks within the previous calendar month.
 - Copies of all payment requests sent to PM within the previous month.
 - Payment receipt notifications with the date payment was received.

JDPF
JDPF

WARR
WARR

- Selected Bidder must develop and submit to the PMs the following but not limited to:
 - Pre-Installation Assessment Visit and Report for each project
 - Case Scope of work for each project.
 - System Designs for each Projects
 - Systems Installation Report
 - Commissioning Report
 - All technical documentation, including Component's data sheets and listing
 - Warranties
 - Installation and operation manuals
 - As-built version of system drawings, cable lists and routing, wirings, grounding system,
 - Any other documentation required or requested by PRDOH.
- Selected Bidder must provide the equipment and installations in accordance with Section 9, Delivery Schedule.

JDPF
JDPF

WRR
WRR

9. Delivery Schedule

- Coordinate with Applicant and CEWRI Program Manager for any pre-installation assessment visits, installation, and closeout inspections.
- Upon notice from the CEWRI PM firm, the selected Bidder shall, within three (3) working days, perform the pre-installation assessment and report.
- Upon notice from the CEWRI PM firm, the selected Bidder shall, within six (6) working days, perform the design of the project.
- Upon notice from the CEWRI PM firm, the selected Bidder shall, within seven (7) working days, install the system(s), perform the commissioning of the project, submission of the Interconnection Package to PREPA, and submission of the Pre-Inspection Package. If the 7-day period is not enough due to equipment shortage, the selected Bidder must provide a written explanation and a copy of the equipment's delivery documents.
- Upon completion of installation, Selected Bidder shall submit the official payment request to CEWRI PM with all applicable documentation, including warranty. Warranty documentation shall be submitted in duplicate (one for PM/PRDOH and one for the homeowner/applicant) Selected Bidder is responsible for delivering warranty information to the homeowner/applicant.

10. Terms and Conditions

The following terms and conditions are designed to state expectations relating to the project and the selected Bidder's work performed. Should the Selected Bidder deviate from these standards and guidelines, all costs and liability associated with the observed deviation will be the Selected Bidder's sole responsibility.

10.1. Interpretation of Scope of Work:

The selected Bidder is responsible for reading and fully understanding the scope of work. The design-build approach allows for continual collaboration; however, any proposed changes to the original proposal must be approved in writing by the Selected Bidder and PM through the change order process before proceeding.

10.2. Existing Conditions:

The selected Bidder is responsible for verifying the installation site's existing conditions as reported in this Invitation for Bids before construction begins.

10.3. Installation Schedule:

The selected Bidder will complete the installation within the timeline described in **Section 9**. Once the installation has begun, the selected Bidder is required to be on-site every day during regular business hours (or at a time pre-arranged with PRDOH) for the full work period until the installation is complete.

- The selected Bidder shall have all required materials in stock prior to beginning installation.
- The selected Bidder shall give the PMs an estimate of the date the installation will be completed and shall inform the PMs if the installation appears to be taking longer than the original estimate.
- Corrections as identified during final acceptance or as a result of the quality control process shall be performed within ten (10) business days unless the problem interrupts PRDOH normal business operations or presents a health and safety threat, in which case the correction shall be made immediately. Exceptions to this rule shall be granted in circumstances beyond the control of the Selected Bidder (e.g., unforeseen existing conditions, material backorders, etc.). The selected Bidder shall notify PRDOH (verbally and in writing) that the correction will or may violate this provision.

10.4. Communication:

The selected Bidder shall respond to information requests within two (2) business days. Response form will be determined by the request. The response may be in the following forms but not be limited to: E-mail, hardcopy, fax.

10.5. Change Orders and Scope of Work Modification:

The contract may be increased or decreased after the proposal is accepted. Under no circumstances shall the selected Bidder deviate from the work defined in the scope of work without advance written approval from PRDOH.

10.6. Final Acceptance:

A project will not be considered complete until all project steps are completed, including quality control inspection, training, and all project deliverables.

END SCOPE OF WORK

JDPF
JDPF

WORR
WORR



GOVERNMENT OF PUERTO RICO
DEPARTMENT OF HOUSING

**Exhibit O-1
COST FORM**

**Invitation for Bids
Increase Capacity**

**PV Systems, Water Storage System Acquisition, and Installation Services
Community Development Block Grant – Disaster Recovery/MIT
CDBG-DR-IFB-2022-03**

Name of Proposer: Caribe Tecno, CRL

Cost Form 1. Unit Pricing

Equipment Description ⁽¹⁾	Price per Unit
Photovoltaic (PV) System with Battery Storage and related Services⁽⁵⁾⁽⁶⁾	
Cost per Watt (\$/W DC)	\$8.556
Water Storage System (WSS) and related Services⁽⁴⁾⁽⁵⁾⁽⁶⁾⁽⁷⁾	
300 gallons WSS	\$5,500.00
350 gallons WSS	\$5,500.00
400 gallons WSS	\$5,550.00
450 gallons WSS	\$5,600.00
500 gallons WSS	\$5,650.00

Notes

- (1) All equipment to be submitted with the Bid to comply with the specifications for such included in the Scope of Work.
- (2) Bidder shall submit technical/specification documentation for all equipment offered as part of the bid.
- (3) All equipment offered as part of the bid is subject to the Warranty conditions set forth in the Scope of Work.
- (4) Bids which do not contain pricing for every item requested will be considered unresponsive by the PRDOH.
- (5) Pricing must include all services associated with the PV System and WSS included in the Scope of Work.
- (6) Pricing must include all expenses, including incidental, taxes, handling, and delivery costs, as well as any other administrative costs associated with the goods and services. The PRDOH will not consider any additional costs. Only the unit prices submitted will be taken into consideration. The PRDOH will not be responsible for reimbursement of expenses related to per-diem, tolls, parts, or labors for equipment under warranty.
- (7) Bidders shall provide the pricing for water storage systems inclusive of a 0.5 horsepower (hp) water pump with a pressurized tank and copper tubing/connections.

JDPF
JDPF

WRR
WRR

Bidder's Initials: _____

Name of Proposer: Caribe Tecno, CRL

Cost Form 2. System Pricing

Equipment Description ⁽⁸⁾	Price per Unit	Qty. ⁽¹⁶⁾	Total
PV System with Battery Storage and related Services⁽¹¹⁾⁽¹²⁾⁽¹³⁾			
3 kW DC with 9kWh/day Battery Storage	\$26,890.00	675	\$18,150,750.00
4.3 kW DC with 12.8 kWh/day Battery Storage	\$33,130.00	225	\$7,454,250.00
[A] Sub-Total PV System			\$25,605,000.00
Water Storage System and related Services⁽¹¹⁾⁽¹²⁾⁽¹³⁾⁽¹⁴⁾⁽¹⁵⁾			
500 Gallons	\$5,650.00	720	\$4,068,000.00
[B] Sub-Total Water Storage System			\$4,068,000.00
Total (PV System + Water Storage System): [A]+[B]			\$29,673,000.00

JDPF
JDPF

WRR
WRR

Notes

- (8) All equipment to be submitted with the Bid must comply with the specifications included in the Scope of Work.
- (9) Bidder shall submit technical/specification documentation for all equipment offered as part of the bid.
- (10) All equipment offered as part of the bid is subject to the Warranty conditions set forth in the Scope of Work.
- (11) Bids which do not contain pricing for every item requested will be considered unresponsive by the PRDOH.
- (12) Pricing must include all services associated with the PV System and WSS included in the Scope of Work.
- (13) Pricing must include all expenses, including incidental, taxes, handling, and delivery costs, as well as any other administrative costs associated with the goods and services. The PRDOH will not consider any additional costs. Only the unit prices submitted will be taken into consideration. The PRDOH will not be responsible for reimbursement of expenses related to per-diem, tolls, parts, or labors for equipment under warranty.
- (14) Bidders shall provide the pricing for water storage systems inclusive of a 0.5 horsepower (hp) water pump with a pressurized tank and copper tubing/connections.
- (15) For quotation purposes, the Bidder will quote for the 500-gallon WSS. The PRDOH will determine, during the assessments of applications, which WSS will be installed at each project from those included in Cost Form 1.
- (16) Maximum quantity of applications included in the Cost Form are the PRDOH's expectation for the current CEWRI allocation of the program at the moment. Therefore, the actual quantities of applications, and therefore units, to be included in the Selected Bidder's contract and that the Selected Proposer might be able to perform will be dependent on the final number of Selected Bidders that might be awarded through the IFB. For Level 1 Contractors, this does not limit the PRDOH in amending the contract of any Selected Bidder to include additional estimated quantities of applications based on performance metrics of the Selected Bidders and according to the Program funds availability. For Level 2 Contractors, PRDOH reserves the right to amend the contracts to include additional applications based on performance metrics up to 500 PV systems and 400 WSS.

Bidder's Initials: _____

Name of Proposer: Caribe Tecno, CRL

Cost Type	Total Amount
PV Systems- Acquisition and Installation	\$25,605,000.00
WSS – Acquisition and Installation	\$4,068,000.00

TOTAL BID COST \$29,673,000.00

Sum of **(a)** PV Systems – Acquisition and Installation Cost; plus, **(b)** WSS – Acquisition and Installation Costs.

Notes on TOTAL PROPOSAL COST:

1. The TOTAL PROPOSAL COST represents the potential total cost for the equipment and services requested for all the PV Systems, Water Cisterns Acquisition and Installation Services.
2. The PRDOH aims to contract, at its discretion and in the best interest of the overall programs' implementation, one or more bidders(s).
3. Based on the number of Bidders finally awarded through this IFB, contracts may be signed to manage quantities of systems lower than those considered in this Cost Form.
4. PRDOH will reserve the discretion to amend contracts of awarded Bidders(s) to include additional amounts of systems based on performance metrics.
5. The Bid is to be awarded to the "Responsible Bidder" that submitted the "Responsive Bid" with the lowest cost, taking in consideration the Contractor Levels and Cost Forms. The Contractor Level must not be used as subterfuge to submit a lower Bid Bond.

END OF COST FORM.

JDPF
JDPF

WORR
WORR



ATTACHMENT D

PERFORMANCE REQUIREMENTS

Increase Capacity PV System and Water Storage System Acquisition and Installation Services Invitation for Bids. CDBG-DR-IFB-2022-03

Scope of Work

The Contractor is responsible for compliance with all aspects of the Scope of Work included as **Attachment B** of the Contract.

Practice of Licensed Professions

Contractor and its subcontractors, agents, and employees, shall comply with all applicable federal and local laws and regulations, including but not limited to those that relate to the practice of licensed professions and those that could affect the Contractor's ability to carry out the Scope of Work under the Contract. Contractor certifies that it possesses all necessary permits, endorsements, and approvals necessary to perform the Work, which are to be valid and updated for the duration of the Contract. Contractor and each of its employees, agents, subcontractors, and subconsultants must have all licenses, permits, authorizations, consents, and approvals necessary for the performance of the Scope of Work under the contract, and such licenses, permit, authorizations, consents, and approvals are to be up to date and in full force and effect from the date of Contract execution and for the duration of the Contract. Contractor must always ensure that professional, architectural, or engineering work is performed by qualified professionals with the proper education, know-how, training, knowledge, expertise, experience, and license to perform such works, according to applicable federal and local rules and regulations.

Code Compliance

Installation and equipment shall comply with applicable building, mechanical, fire, seismic, structural, and electrical codes, included in the Joint Regulation for the Evaluation and Grant of Permits Related to Developments, Land Use, and Business Operations (Joint Regulation), as amended. The Contractor must abide by the "Joint Regulation", as amended, "Regulation No. 7796", "Regulation No. 8080," and any other State regulation that regulates the installations within this Program.

Contractor must install solar system equipment in compliance with Puerto Rico Residential Code 2018 (PRRC), National Electric Code (NEC), Puerto Rico Electrical Power Authority (PREPA) and Permit Management Office (OGPe, for its Spanish acronym) Regulations, as they may be amended.

Deliverables

The key deliverables to be provided include, but are not limited to, the following:

- Installer/Contractor must submit monthly reports to CEWRI Program Manager and PRDOH. Monthly reports shall be due the fifth (5th) day of each month and shall include:
 - Copies of all notifications from CEWRI PMs
 - Inspection orders placed within previous calendar month and inspection reports, as applicable.
 - Notices to begin the design phase within the previous calendar month
 - Notices of accepted/rejected designs within previous calendar month

JDPF
JDPF

WRR
WRR

- Locations of all pending and completed tasks within the previous calendar month.
 - Explanation of pending and completed design tasks within the previous calendar month.
 - Explanation of pending and completed installation tasks within the previous calendar month.
 - Copies of all payment requests sent to PM within the previous month.
 - Payment receipt notifications with the date payment was received.
- Installer/Contractor must develop and submit to the PMs the following but not limited to:
- Pre-Installation Assessment Visit and Report for each project
 - Case Scope of work for each project
 - System Designs for each Projects
 - Commissioning Report
 - All technical documentation, including Component data sheets and listing
 - Warranties
 - Installation and operation manuals
 - As-built version of system drawings, cable lists and routing, wirings, grounding system,
 - Any other documentation required or requested by PRDOH.

Delivery Schedule

- Coordinate with Applicant and CEWRI Program Manager for any pre-installation assessment visits, installation, and closeout inspections.
- Upon notice from the CEWRI PM firm, the Installer/Contractor shall perform the pre-installation assessment and report within the timeframe indicated in the table below.
- Upon notice from the CEWRI PM firm, the Installer/Contractor shall perform the design of the project and submission of the Interconnection Package to PREPA within the timeframe indicated in the table below.
- Upon notice from the CEWRI PM firm, the Installer/Contractor shall install the system(s), perform the commissioning of the project, and submission of the Pre-Inspection Package within the timeframe indicated in the table below. If the afforded timeframe is not enough due to equipment shortage, the Installer/Contractor must provide a written explanation and a copy of the equipment's delivery documents.
- Upon completion of installation, Installer/Contractor shall submit the official payment request to CEWRI PM with all applicable documentation, including warranty. Warranty documentation shall be submitted in duplicate (one for PM/PRDOH and one for the homeowner/applicant) Installer/Contractor is responsible for delivering warranty information to the homeowner/applicant.

JDPF
JDPF

WORR
WORR

Tasks and Services	DESCRIPTION	TIMEFRAME DATES	DELIVERABLES
Pre-Installation Assessment and Scope of Work	<ul style="list-style-type: none"> - Perform a Pre-Installation Assessment visit to each dwelling units and develop the Pre-Installation Assessment report for each case project. Submit report to the PMs for approval. -Develop case Scope of Work for each project. Submit scope of work to the PMs for approval. 	<p>Upon notice from the CEWRI PM firm, the Installer/Contractor shall, within ten (10) business days, perform the pre-installation assessment and report.</p>	<p>For each Application, provide the Pre-Installation Report Form signed and sealed by the licensed professional, and provide any other document required by PRDOH.</p>
Design Services & Permits	<p>The Installer/Contractor must design a standard photovoltaic system with battery back-up and/or Water Storage System for single-family homes.</p>	<p>Upon notice from the CEWRI PM firm, the Installer/Contractor shall, within six (6) business days, perform and submit the design of the project.</p>	<p>For each assigned project, the Installer/Contractor must submit System Designs and any applicable permit for each Projects.</p>
Installation Service & Commissioning	<ul style="list-style-type: none"> - For each assigned project, the Installer/Contractor shall install the system(s) and perform the commissioning of the project. - The Installer/Contractor shall perform orientation and training to the Applicants regarding operation and maintenance of the installed systems and equipment. - The Installer/Contractor must deliver all applicable Operation and Maintenance Manuals of the installed systems to each Applicant receiving a system along with any other required documents. 	<p>Upon notice from the CEWRI PM firm, the Installer/Contractor shall, within seven (7) business days, install the system(s), perform the commissioning of the project, and submission of the Pre-Inspection Package. If the 7-day period is not enough due to equipment shortage, the Installer/Contractor must provide a written explanation and a copy of the equipment's delivery documents.</p>	<p>For each assigned project, the Installer/Contractor must submit the Pre-Inspection Package, including but not limited to the Commissioning Report, all technical documentation, including components data sheets and listing, warranties, installation and operation & maintenance manuals, as-built version of system drawings, cable lists and routing, wirings, grounding system, and any other document required by PRDOH. The Pre-Inspection package must also include evidence of submission of the Interconnection Package to the utility company.</p>

JDPF
JDPF

WORR
WORR

Tasks and Services	DESCRIPTION	TIMEFRAME DATES	DELIVERABLES
<p>Award Visit</p>	<ul style="list-style-type: none"> -Perform award visit with the PMs to each applicant's property to complete the Project Grant Agreement. -Perform orientation to Applicants of the measures that are being offered and that may be installed in the unit. -Ensure that the applicant is informed on the process, the works to be performed, and the conditions of the award prior to any work being performed. - Assist the PMs during the applicant award process. 	<ul style="list-style-type: none"> - As per coordination with Applicant and CEWRI Program Manager for award visit. 	<p>For each assigned project, the Installer/Contractor must participate and assist in the Award Visit.</p>
<p>Inspections</p>	<p>For each project the Installer/Contractor will visit the project site along with the PRDOH Program Manager and inspect works for overall quality standards.</p>	<ul style="list-style-type: none"> - As per coordination with Applicant and CEWRI Program Manager for closeout inspections. -Installation corrections, as noted during final acceptance or the post- installation inspection, shall be performed within ten (10) business days. If the Installer/Contractor cannot undertake corrective actions within ten (10) business days, the Installer/Contractor shall deliver to the PM, in writing, reasons for the delay. 	<p>For each assigned project, the Installer/Contractor must participate and assist in the Inspection Visit.</p>

JDPF
JDPF

WORR
WORR

Tasks and Services	DESCRIPTION	TIMEFRAME DATES	DELIVERABLES
<p>Reporting</p>	<p>-Periodic Reporting is required to update the Program's implementation and development status, while providing visibility of the Program's actual status to stakeholders.</p>	<p>-Installer/Contractor must submit monthly reports to CEWRI Program Manager and PRDOH. Monthly reports shall be due the fifth (5th) day of each month</p>	<p>The Installer/Contractor shall submit the following:</p> <ul style="list-style-type: none"> - Copies of all notifications from CEWRI PMs - Inspection orders placed within previous calendar month and inspection reports, as applicable. - Notices to begin the design phase within the previous calendar month - Notices of accepted/rejected designs within previous calendar month - Locations of all pending and completed tasks within the previous calendar month. - Explanation of pending and completed design tasks within the previous calendar month. - Explanation of pending and completed installation tasks within the previous calendar month. - Copies of all payment requests sent to PM within the previous month. - Payment log. - Any other document required by PRDOH.

JDPF
JDPF

WORR
WORR

At PRDOH's discretion and in benefit to the Program, taking into consideration the particular circumstances of each case, timelines may be modified without the need to amend the contract.

The Installer/Contractor shall develop workplans, schedules, reports and/or any other document as may be requested by PRDOH or Representative in connection to the above timelines and performance goals. The Installer/Contractor shall submit any of such documents for review and approval as requested by the PRDOH within the specified time frame provided for such request. PRDOH reserves the rights to request any information as part of the Grantee responsibilities. The Installer/Contractor is also responsible for providing and performing all the services stated in the Scope of Work.

Liquidated Damages & Penalties

Contractor performance is subject to the following liquidated damages and penalties:

- **Liquidated Damages:** The Contractor shall pay to PRDOH, as liquidated damages, as related to their timeframes of performance. The PRDOH and the Contractor will agree on the timetable for the deliverable of each task. The Contractor shall pay to the PRDOH, as

liquidated damages, the amount established below for each calendar day that a deliverable required is late until deemed in compliance subject to a maximum amount as established below.

Type of Work	Liquidated Damages for each calendar day	Maximum Amount of Liquidated Damages per occurrence, deliverable and task
PV System Equipment, Installation, and related services	\$500.00	\$5,000.00
WSS Equipment, Installation, and related services	\$100.00	\$1,000.00

Said sums, in view of the difficulty of accurately ascertaining the loss which PRDOH and/or homeowner will suffer by reason of delay in the completion of Works requested, are hereby fixed and agreed as the liquidated damages that PRDOH and/or the homeowner will suffer by reason of such delay. Liquidated damages received are not intended to be nor shall they be treated as either a partial or full waiver or discharge of the PRDOH's right to indemnification, or the Contractor's obligation to indemnify the PRDOH, or to any other remedy provided for as a provision of the Contract or Law. Liquidated damages may be assessed at the sole discretion of PRDOH. For the purpose of applying and calculating such liquidated damages, a grace period of ten (10) days shall be observed. The PRDOH may deduct and retain out of the monies which may become due to the Contractor, the amount of any such liquidated damages; and in case the amount which may become due is less than the amount of liquidated damages due to the PRDOH per the formula above, the Contractor shall be liable to pay the difference.

JDPF
JDPF

WORR
WORR



**Insurance Requirements - Amended
Invitation for Bid
Increase Capacity
PV Systems, Water Cisterns Acquisition and Installation Services
CEWRI Program
Community Development Block Grant – Disaster Recovery/Mitigation
Puerto Rico Department of Housing
Contract Division**

**SPECIAL INSURANCE AND BONDING SPECIFICATIONS
FOR PROFESSIONAL SERVICES**

LICITATION NUMBER: CDBG-DR-IFB-2022-03

A. All bidders will submit a BID BOND

The bid will be accompanied of a bid bond of five percent (5%) of the amount of the bid and option of the bidder, which will be able to be my means of:

- a. Certified check, or
- b. Bank draft

The Bid Bond must be issued by a surety appearing in the latest US Department of Treasury's Listing of Approved Sureties (Circular Letter 570) and authorized to do business in Puerto Rico.

- B.** The successful bidder before commencing work or receiving a written notice to proceed with, or being allowed to start to work, must submit to the ***Puerto Rico Department of Housing (*PRDOH)***, the hereafter mentioned insurance policies and/or bonds, thus including all endorsements and agreements required under the special contractual conditions as per the following:

1. (X) State Insurance Fund Workmen's Compensation Insurance Policy

In accordance with the Workmen's Compensation Act No. 45, to facilitate its acquisition, the ****PRDOH*** shall provide a letter to the successful bidder addressed to the State Insurance Fund.

JDPF
JDPF

WORR
WORR

2. (X) Commercial General Liability (Broad Form) including the following insurance coverage

COVERAGE	LIMIT
I. Commercial General Liability:	
• Each Occurrence	\$2,000,000
• General Aggregate	\$2,000,000
• Products & Complete Operations	\$2,000,000
• Personal Injury & Advertising	\$2,000,000
• Fire Damage	\$100,000 (Any one Fire)
• Medical Expense	\$10,000 (Any one person)
II. Employer's Liability Stop Gap:	
• Bodily Injury by Accident Each Employee Each Accident	\$1,000,000 \$1,000,000
• Bodily Injury by Disease Each Employee Each Accident	\$1,000,000 \$1,000,000

JDPF
JDPF

WORR
WORR

3. (X) Comprehensive Automobile Liability Form including the following insurance coverages

LIMIT
<ul style="list-style-type: none"> • Auto Liability - \$1,000,000 • Physical Damages - \$1,000,000 • Medical Payments - \$ 10,000
The Commercial Auto cover must be applied to the following symbols:
• Liability Coverage -1
• Physical Damages – 2 and 8
• Hired – Borrowed Auto – 8
• Non-Owned Auto Liability – 9

4. (X) Professional Liability and/or Errors & Omissions

(X) A. Risk, interest, location and limits

(X) A.1 Description of work to be done

(X) A.2 Limit:

(X) each occurrence \$ 5,000,000

(X) Aggregate \$ 5,000,000

(X) Deductible \$ 10,000

(X) A.3 Certification that the insurance contract has been given as surplus lines coverage under the Commonwealth Insurance Code, when applicable.

5. (X) Employment Practices Liability

Limit - \$1,000,000

6. (X) Contractor's Pollution Liability

Limit - \$1,000,000

7. (X) Umbrella

Limit - \$10,000,000

8. (X) Builder's Risk – 100% of Finished Value

(x) a. Form for all risks including "DIC" and earthquake.

(x) b. 100% total finished cash value for all finished construction equipment and/or installation equipment.

(x) c. The "PRDOH", HUD and the Government of Puerto Rico must be included as additional insured.

9. (X) Payment and Performance Bond, Wage Payment Bond, and Labor Materials Payment Bond:

(X) a. The successful bidder must provide a Payment & Performance Bond for the total cost of the project under contract.

(X) b. The surety must be issued by a surety appearing in the latest US Department of Treasury's Listing of Approved Sureties (Circular Letter 570) and authorized to do business in Puerto Rico.

JDPF
JDPF

WORR
WORR

(X) c. You must provide an endorsement on the Performance and Payment Bond to guarantee the payment of wages at the Department of Labor of the Government of Puerto Rico as an Obligated Guarantor under Laws of Puerto Rico.

(X) d. Certificate of Authority, Power of Attorney and Power of Attorney License issued by the Commissioner of Insurance.

(X) e. Performance and payment bonds will be required for 100% of the contract price to cover the construction work and the standard one year warranty/maintenance period after completion of the work.

10. The policies to be obtained must contain the following endorsements including as additional insured the ***Puerto Rico Department of Housing (*PRDOH), U.S. Department of Housing and Urban Development (HUD),*** and the ***Government of Puerto Rico.***

(X) a. Breach of warranty

(X) b. Waiver and / or Release of Subrogation

(X) c. Additional Insured Clause

(X) d. Hold Harmless Agreement

(X) e. 30 Days Cancellation Clause

11. The insurance carrier or carriers, which will present said certificates of insurance must have at least a B+ Rating according to the Best Rating Guide.

C. TERMS AND CONDITIONS

1. All certified checks or bank drafts must be paid to the Order of the Bidding Agency.

2. All Bid Bonds must be issued by an Insurance Company authorized by the Insurance Commissioner of Puerto Rico and must be accompanied by the following documents:

3. Certificate of Authority in the name of the Insurer issued by the Insurance Commissioner.

4. Power of Attorney, issued by the Insurer, in the name of its attorney-in-fact.

JDPF
JDPF

WORR
WORR

5. Power of Attorney License, issued by the Commissioner of Insurance pursuant to the power of attorney issued by said Insurer.

6. If, at the time the bidding, documents are opened, any of the documents referred to in paragraph a, band c above are missing, this shall not constitute grounds for disqualifying the contractor, but the successful bidder shall submit such documents within two (2) working days from the date and time of the auction.

7. It is implicit that, by issuing the Bid Bond, the insurer undertakes to issue a Performance and Payment Bond in accordance with the conditions of the auction.

8. In any bidding or protest, the interested party shall be obliged to write down each risk with its individual cost of premium and shall then reflect the total sum of all insurance premiums as project costs.

D. IMPORTANT NOTICE TO INSURANCE AND SURETY COMPANIES AND THEIR REPRESENTATIVES

All insurance companies and all guarantors who issue policies or bonds under our special contractual conditions are subject to:

1. Be authorized to do business within the Commonwealth of Puerto Rico and have the corresponding license issued by the Commissioner of Insurance.
2. To be enjoying a good economic situation and to be classified under the Category of B+ Rating according to the "Best Rating Guide".
3. Submit to the ***PRDOH** a written certification as evidence of full payment of premiums by the Contractor. Mention each risk coverage premium separately.
4. Avoid sub-contractual obligations of premium financing or any other kind, which may be detrimental to the public interest.
5. Avoid any request for cancellation by the contractor prior to the expiration date of the policy, without the consent of the Contract Division of the ***PRDOH**: Discuss any refund of unearned premium.

JDPF
JDPF

WORR
WORR

6. Follow all Federal Bail and Acceptance Insurance Regulations, when applicable.
7. Indicate in the appropriate place of all insurance policies and/or bonds, the full description of the project, work or service to be rendered.
8. Not to make any amendments to insurance policies and bonds issued under the special conditions mentioned above, unless approved by the Insurance Section of the ***PRDOH**.
9. To ensure that all insurance policies or bonds are issued to comply with all of our special insurance conditions with respect to the period of coverage, type of risk coverage, as well as all limits, as specified, and also to eliminate those exclusions in accordance with our request.
10. Clarify any questions regarding insurance requirements by any means of communication with the Insurance Section of the ***PRDOH** under the Secretary for Legal Affairs.

E. EVIDENCE OF INSURANCE COVERAGE OF EACH SUBCONTRACTOR TO BE SUBMITTED BY THE SUCCESSFUL BIDDER AS THE PRIME CONTRACTOR:

The successful bidder, as the prime contractor, has the duty to require each of the subcontractors or subcontractors to maintain in force all insurance policies and/or bonds necessary to cover their individual participation in the risk or risks related to the subcontracted work or service to be rendered.

Therefore, we emphasize that prior to commencing work or receiving written notice to proceed with such work or being authorized to commence work, the successful prime contractor has the responsibility to provide the ***PRDOH** with evidence to the effect that all insurance and/or bonds required under the special conditions or required under the sub-contract to each of the sub-contractors or sub-sub-contractors are current and duly approved by the Contract Division of the ***PRDOH**.

All insurance policies shall remain in effect for the entire contractual period, so that with any order of change and/or amendment resulting in alteration of the original project completion date or total

JDPF
JDPF

WORR
WORR

original cost, the prime contractor shall take the necessary steps to request the insurer to include such changes in all related insurance policies and/or bonds and to submit evidence by appropriate endorsements with effective dates. Cancellations without consent are not accepted.

The ***PRDOH** reserves the right to stop any work or service under contract until the breach of these requirements has been remedied, so that any delay in the performance of the contract based on any breach of the insurance coverage requirements shall be deemed the sole responsibility of the Main Contractor.

F. CONFLICT OR DIFFERENCE BETWEEN THE SPECIFICATIONS OF THE TENDERING, PROCEDURE AND SPECIAL INSURANCE CONDITIONS AND BONDS

In the event of any conflict or difference in the description of coverage or in amounts or limits, etc., with respect to insurance requirements, the "*Special Conditions of Insurance and Bonds*" as set forth in this **Insurance Requirements** shall prevail over any other insurance specifications.

****PRDOH reserves the right to modify any Insurance Requirements at any time, in accordance with the Program's needs.***

G. CERTIFICATE OF CONTRACT DIVISION

We hereby certify, to our best knowledge and understanding, that we have prepared the aforementioned "*Insurance and Bonds Special Conditions*" after a proper evaluation of the related risks, based on the information of the nature of the project and description submitted to us, as requested by the Contracting Program through a written application.

DESCRIPTION OF THE SERVICES:

**Increase Capacity
PV Systems, Water Cisterns Acquisition and Installation Services
CEWRI Program**

JDPF
JDPF

WORR
WORR

March 3rd, 2022

Date

Candice M. Noriega Morales

Candice M. Noriega Morales
Insurance Specialist
CDBG-DR Program

JDPF
JDPF

WRR
WRR



ATTACHMENT F HUD GENERAL PROVISIONS

Given that the Contract involves funds for which the U.S. Department of Housing and Urban Development (**HUD**) is the oversight agency, the following terms and conditions may apply to this Contract. In addition, Contractor shall comply with the Federal Labor Standards Provisions set forth in Form HUD-4010, available at <https://www.hudexchange.info/resource/2490/hud-form-4010-federal-labor-standards-provisions/>.

The CONTRACTOR shall include these terms and conditions in all subcontracts or purchase orders directly servicing the Contract.

These general provisions may be updated from time to time. It is the sole responsibility of the CONTRACTOR to be aware of any changes hereto, to amend and implement such changes and to ensure subcontracts terms and conditions are modified as necessary, if any.

General Provisions:

1. PROVISIONS REQUIRED BY LAW DEEMED INSERTED

Each and every provision of law and clause required by law to be inserted in this Contract shall be deemed to be inserted herein and the Contract shall be read and enforced as though it were included herein, and if through mistake or otherwise any such provision is not inserted, or is not correctly inserted, then upon the application of either party, the Contract shall forthwith be physically amended to make such insertion or correction.

2. STATUTORY AND REGULATORY COMPLIANCE

CONTRACTOR shall comply with all laws and regulations applicable to the Community Development Block Grant-Disaster Recovery funds appropriated by: the Continuing Appropriations Act, 2018, and Supplemental Appropriations for Disaster Relief Requirements, 2017 (**Pub. L. 115-56**) approved on September 8, 2017, as amended; the Bipartisan Budget Act of 2018 (**Pub. L. 115-123**) approved on February 9, 2018, as amended; the Additional Supplemental Appropriations for Disaster Relief Act, 2019, (**Pub. L. 116-20**) approved on June 6, 2019, as amended; as well as including, but not limited to, the applicable Office of Management and Budget Circulars, which may impact the administration of funds and/or set forth certain cost principles, including if certain expenses are allowed.

JDPF
JDPF

WRR
WRR

3. BREACH OF CONTRACT TERMS

The Puerto Rico Department of Housing (**PRDOH**) reserves its right to all administrative, contractual, or legal remedies, including but not limited to suspension or termination of this Contract, in instances where the CONTRACTOR or any of its subcontractors violate or breach any Contract term. If the CONTRACTOR or any of its subcontractors violate or breach any Contract term, they shall be subject to such sanctions and penalties as may be appropriate. The duties and obligations imposed by the Contract documents, and the rights and remedies available thereunder shall be in addition to and not a limitation of any duties, obligations, rights and remedies otherwise imposed or available by law.

4. REPORTING REQUIREMENTS

The CONTRACTOR shall complete and submit all reports, in such form and according to such schedule, as may be required by PRDOH and/or the Government of Puerto Rico. The CONTRACTOR shall cooperate with all the PRDOH and/or the Government of Puerto Rico efforts to comply with HUD requirements and regulations pertaining to reporting, including but not limited to 24 C.F.R. §§ 85.40-41 (or 84.50-52, if applicable) and § 570.507, when applicable.

5. ACCESS TO RECORDS

The Government of Puerto Rico, the PRDOH, HUD, the Comptroller General of the United States, or any of their duly authorized representatives, shall have, at any time and from time to time during normal business hours, access to any work product, books, documents, papers, and records of the CONTRACTOR which are related to this Contract, for the purpose of inspection, audits, examinations, and making excerpts, copies and transcriptions.

6. MAINTENANCE/RETENTION OF RECORDS

All records (files, data, work product) connected with this Contract will be turned over to PRDOH following the Agreement termination to be maintained for the remainder of the grant and post grant closeout.

7. SMALL AND MINORITY FIRMS, WOMEN'S BUSINESS ENTERPRISES, AND LABOR SURPLUS AREA FIRMS

The CONTRACTOR will take necessary affirmative steps to assure that minority firms, women's business enterprises, and labor surplus area firms are used in subcontracting when possible. Steps include, but are not limited to:

- (i) Placing qualified small and minority businesses and women's business enterprises on solicitation lists;

JDPF
JDPF

WORR
WORR

- (ii) Assuring that small and minority businesses, and women's business enterprises are solicited whenever they are potential sources;
- (iii) Dividing total requirements, when economically feasible, into smaller tasks or quantities to permit maximum participation by small and minority business, and women's business enterprises;
- (iv) Establishing delivery schedules, where the requirement permits, which encourage participation by small and minority business, and women's business enterprises; and
- (v) Using the services and assistance of the Small Business Administration, and the Minority Business Development Agency of the Department of Commerce.

Additionally, for contracts of **\$10,000 or more**, the CONTRACTOR shall file Form HUD 2516 (Contract and Subcontract Activity) with the PRDOH on a quarterly basis.

8. RIGHTS TO INVENTIONS MADE UNDER A CONTRACT OR AGREEMENT

Contracts or agreements for the performance of experimental, developmental, or research work shall provide for the rights of the Federal Government and the recipient in any resulting invention in accordance with 37 C.F.R. Part 401, "Rights to Inventions Made by Nonprofit Organizations and Small Business Firms Under Government Grants, Contracts and Cooperative Agreements", and any implementing regulations issued by HUD.

9. TITLE VI OF THE CIVIL RIGHTS ACT OF 1964

The Proposer will comply with the provisions of Title VI of the Civil Rights Act of 1964, which prohibits discrimination on the basis of race, color, or national origin in any program or activity that receives Federal funds or other Federal financial assistance. Programs that receive Federal funds cannot distinguish among individuals on the basis of race, color or national origin, either directly or indirectly, in the types, quantity, quality or timelines of program services, aids or benefits that they provide or the manner in which they provide them. This prohibition applies to intentional discrimination as well as to procedures, criteria or methods of administration that appear neutral but have a discriminatory effect on individuals because of their race, color, or national origin. Policies and practices that have such an effect must be eliminated unless a recipient can show that they were necessary to achieve a legitimate nondiscriminatory objective.

10. SECTION 109 OF THE HOUSING AND COMMUNITY DEVELOPMENT ACT OF 1974

The CONTRACTOR shall comply with the provisions of Section 109 of the Housing and Community Development Act of 1974. No person in the United States shall on the grounds of race, color, national origin, religion or sex be excluded from participation in, be denied the benefits of, or be subjected to discrimination under any program or activity funded in whole or in part with funds made available under this title. Section 109 further provides

JDPF
JDPF

WORB
WORB

that discrimination on the basis of age under the Age Discrimination Act of 1975 or with respect to an otherwise qualified handicapped individual as provided in Section 504 of the Rehabilitation Act of 1973, as amended, is prohibited.

11. SECTION 504 OF THE REHABILITATION ACT OF 1973

The CONTRACTOR shall comply with Section 504 of the Rehabilitation Act of 1973 (29 U.S.C. § 794), as amended, and any applicable regulations.

The CONTRACTOR agrees that no qualified individual with handicaps shall, solely on the basis of handicap, be excluded from participation in, be denied the benefits of, or otherwise be subjected to discrimination under any program or activity that receives Federal financial assistance from HUD.

12. AGE DISCRIMINATION ACT OF 1975

The CONTRACTOR shall comply with the Age Discrimination Act of 1975 (42 U.S.C. § 6101 *et seq.*), as amended, and any applicable regulations. No person in the United States shall, on the basis of age, be excluded from participation in, be denied the benefits of, or be subjected to, discrimination under, any program or activity receiving Federal financial assistance.

13. DEBARMENT, SUSPENSION, AND INELIGIBILITY

The CONTRACTOR represents and warrants that it and its subcontractors are not debarred or suspended or otherwise excluded from or ineligible for participation in Federal assistance programs subject to 2 C.F.R. Part 2424.

14. CONFLICTS OF INTEREST

The CONTRACTOR shall notify the PRDOH as soon as possible if this Contract or any aspect related to the anticipated work under this Contract raises an actual or potential conflict of interest (as defined at 2 C.F.R. Part 215 and 24 C.F.R. § 85.36 or 84.42, if applicable). The CONTRACTOR shall explain the actual or potential conflict in writing in sufficient detail so that the PRDOH is able to assess such actual or potential conflict. The CONTRACTOR shall provide the PRDOH any additional information necessary to fully assess and address such actual or potential conflict of interest. The CONTRACTOR shall accept any reasonable conflict mitigation strategy employed by the PRDOH, including but not limited to the use of an independent subcontractor(s) to perform the portion of work that gives rise to the actual or potential conflict.

JDPF
JDPF

WORR
WORR

15. SUBCONTRACTING

When subcontracting, the CONTRACTOR shall solicit for and contract with such subcontractors in a manner providing for fair competition. Some of the situations considered to be restrictive of competition include, but are not limited to:

- (i) Placing unreasonable requirements on firms in order for them to qualify to do business;
- (ii) Requiring unnecessary experience and excessive bonding;
- (iii) Noncompetitive pricing practices between firms or between affiliated Companies;
- (iv) Noncompetitive awards to consultants that are on retainer contracts,
- (v) Organizational conflicts of interest;
- (vi) Specifying only a brand name product instead of allowing an equal product to be offered and describing the performance of other relevant requirements of the procurement; and
- (vii) Any arbitrary action in the procurement process.

The CONTRACTOR represents to the PRDOH that all work shall be performed by personnel experienced in the appropriate and applicable profession and areas of expertise, taking into account the nature of the work to be performed under this Contract.

The CONTRACTOR will include these HUD General Provisions in every subcontract issued by it, so that such provisions will be binding upon each of its subcontractors as well as the requirement to flow down such terms to all lower-tiered subcontractors.

16. ASSIGNABILITY

The CONTRACTOR shall not assign any interest in this Agreement, and shall not transfer any interest in the same (whether by assignment or novation) without prior written approval of the PRDOH.

17. INDEMNIFICATION

The CONTRACTOR shall indemnify, defend, and hold harmless the Government of Puerto Rico and PRDOH, its agents and employees, from and against any and all claims, actions, suits, charges, and judgments arising from or related to the negligence or willful misconduct of the CONTRACTOR in the performance of the services called for in this Contract.

18. COPELAND "ANTI-KICKBACK" ACT

(Applicable to all construction or repair contracts)

Salaries of personnel performing work under this Contract shall be paid unconditionally and not less often than once a month without payroll deduction or rebate on any account except only such payroll deductions as are mandatory by law or permitted by

JDPF
JDPF

WORR
WORR

the applicable regulations issued by the Secretary of Labor pursuant to the Copeland "Anti-Kickback Act" of June 13, 1934 (48 Stat. 948; 62 Stat. 740; 63 Stat. 108; Title 18 U.S.C. § 874; and Title 40 U.S.C. § 276c). The CONTRACTOR shall comply with all applicable "Anti-Kickback" regulations and shall insert appropriate provisions in all subcontracts covering work under this Agreement to ensure compliance by subcontractors with such regulations, and shall be responsible for the submission of affidavits required of subcontractors thereunder except as the Secretary of Labor may specifically provide for variations of or exemptions from the requirements thereof.

19. CONTRACT WORK HOURS AND SAFETY STANDARDS ACT

(Applicable to construction contracts exceeding \$2,000 and contracts exceeding \$2,500 that involve the employment of mechanics or laborers)

The CONTRACTOR shall comply with Sections 103 and 107 of the Contract Work Hours and Safety Standards Act (40 U.S.C. §§ 3701-3708) as supplemented by Department of Labor regulations (29 C.F.R. Part 5).

All laborers and mechanics employed by CONTRACTORS or subcontractors shall receive overtime compensation in accordance with and subject to the provisions of the Contract Work Hours and Safety Standards Act, and the CONTRACTORS and subcontractors shall comply with all regulations issued pursuant to that act and with other applicable Federal laws and regulations pertaining to labor standards.

20. DAVIS-BACON ACT

(Applicable to construction contracts exceeding \$2,000 when required by Federal program legislation)

The CONTRACTOR shall comply with the Davis Bacon Act (40 U.S.C. § 3141, *et seq.*) as supplemented by Department of Labor regulations (29 C.F.R. Part 5).

All laborers and mechanics employed by CONTRACTORS or subcontractors, including employees of other governments, on construction work assisted under this Contract, and subject to the provisions of the federal acts and regulations listed in this paragraph, shall be paid wages at rates not less than those prevailing on similar construction in the locality as determined by the Secretary of Labor in accordance with the Davis-Bacon Act.

On a semi-annual basis, the CONTRACTOR shall submit Form HUD 4710 (Semi-Annual labor Standards Enforcement Report) to PRDOH.

JDPF
JDPF

WORR
WORR

21. TERMINATION FOR CAUSE

(Applicable to contracts exceeding \$10,000)

If, through any cause, the CONTRACTOR shall fail to fulfill in a timely and proper manner his or her obligations under this Contract, or if the CONTRACTOR shall violate any of the covenants, agreements, or stipulations of this Contract, the PRDOH shall thereupon have the right to terminate this Contract by giving written notice to the CONTRACTOR of such termination and specifying the effective date thereof, at least five (5) days before the effective date of such termination. In such event, all finished or unfinished documents, data, studies, surveys, drawings, maps, models, photographs, and reports prepared by the CONTRACTOR under this Agreement shall, at the option of the PRDOH, become the PRDOH's property and the CONTRACTOR shall be entitled to receive just and equitable compensation for any work satisfactorily completed hereunder. Notwithstanding the above, the CONTRACTOR shall not be relieved of liability to the Government of Puerto Rico and PRDOH for damages sustained by the Government of Puerto Rico and/or PRDOH by virtue of any breach of the Agreement by the CONTRACTOR, and the Government of Puerto Rico and/or PRDOH may withhold any payments to the CONTRACTOR for the purpose of set-off until such time as the exact amount of damages due to the Government of Puerto Rico and/or PRDOH from the CONTRACTOR is determined.

22. TERMINATION FOR CONVENIENCE

(Applicable to contracts exceeding \$10,000)

The PRDOH may terminate this Contract at any time by giving at least ten (10) days' notice in writing to the CONTRACTOR. If the Contract is terminated by the PRDOH as provided herein, the CONTRACTOR will be paid for the time provided and expenses incurred up to the termination date.

23. SECTION 503 OF THE REHABILITATION ACT OF 1973

(Applicable to contracts exceeding \$10,000)

The CONTRACTOR shall comply with Section 503 of the Rehabilitation Act of 1973 (29 U.S.C. § 793), as amended, and any applicable regulations.

Equal Opportunity for Workers with Disabilities:

- 1) The CONTRACTOR will not discriminate against any employee or applicant for employment because of physical or mental disability in regard to any position for which the employee or applicant for employment is qualified. The CONTRACTOR agrees to take affirmative action to employ, advance in employment and otherwise treat qualified individuals with disabilities without discrimination based on their physical or mental disability in all employment practices, including the following:

JDPF
JDPF

WDRR
WDRR

- (i) Recruitment, advertising, and job application procedures;
- (ii) Hiring, upgrading, promotion, award of tenure, demotion, transfer, layoff, termination, right of return from layoff and rehiring;
- (iii) Rates of pay or any other form of compensation and changes in compensation;
- (iv) Job assignments, job classifications, organizational structures, position descriptions, lines of progression, and seniority lists;
- (v) Leaves of absence, sick leave, or any other leave;
- (vi) Fringe benefits available by virtue of employment, whether or not administered by the CONTRACTOR;
- (vii) Selection and financial support for training, including apprenticeship, professional meetings, conferences, and other related activities, and selection for leaves of absence to pursue training;
- (viii) Activities sponsored by the CONTRACTOR including social or recreational programs; and
- (ix) Any other term, condition, or privilege of employment.

- 2) The CONTRACTOR agrees to comply with the rules, regulations, and relevant orders of the Secretary of Labor issued pursuant to the act.
- 3) In the event of the CONTRACTOR's noncompliance with the requirements of this clause, actions for noncompliance may be taken in accordance with the rules, regulations, and relevant orders of the Secretary of Labor issued pursuant to the act.
- 4) The CONTRACTOR agrees to post in conspicuous places, available to employees and applicants for employment, notices in a form to be prescribed by the Deputy Assistant Secretary for Federal Contract Compliance Programs, provided by or through the contracting officer. Such notices shall state the rights of applicants and employees as well as the CONTRACTOR'S obligation under the law to take affirmative action to employ and advance in employment qualified employees and applicants with disabilities. The CONTRACTOR must ensure that applicants and employees with disabilities are informed of the contents of the notice (e.g., the CONTRACTOR may have the notice read to a visually disabled individual, or may lower the posted notice so that it might be read by a person in a wheelchair).
- 5) The CONTRACTOR will notify each labor organization or representative of workers with which it has a collective bargaining agreement or other contract understanding, that the CONTRACTOR is bound by the terms of Section 503 of the Rehabilitation Act

JDPF
JDPF

WORR
WORR

of 1973, as amended, and is committed to take affirmative action to employ and advance in employment individuals with physical or mental disabilities.

- 6) The CONTRACTOR will include the provisions of this clause in every subcontract or purchase order in excess of \$10,000, unless exempted by the rules, regulations, or orders of the Secretary issued pursuant to Section 503 of the act, as amended, so that such provisions will be binding upon each subcontractor or vendor. The CONTRACTOR will take such action with respect to any subcontract or purchase order as the Deputy Assistant Secretary for Federal Contract Compliance Programs may direct to enforce such provisions, including action for noncompliance.

24. EQUAL EMPLOYMENT OPPORTUNITY

(Applicable to construction contracts and subcontracts exceeding \$10,000)

The CONTRACTOR shall comply with Executive Order 11246 of September 24, 1965, entitled "Equal Employment Opportunity," as amended by Executive Order 11375 of October 13, 1967, and as supplemented in Department of Labor regulations (41 C.F.R. chapter 60).

During the performance of this Agreement, the CONTRACTOR agrees as follows:

- 1) The CONTRACTOR shall not discriminate against any employee or applicant for employment because of race, color, religion, sex, or national origin. The CONTRACTOR shall take affirmative action to ensure that applicants for employment are employed, and that employees are treated during employment, without regard to their race, color, religion, sex, or national origin. Such action shall include, but not be limited to, the following: employment, upgrading, demotion, or transfer; recruitment or recruitment advertising; layoff or termination; rates of pay or other forms of compensation; and selection for training, including apprenticeship.
- 2) The CONTRACTOR shall post in conspicuous places, available to employees and applicants for employment, notices to be provided by Contracting Officer setting forth the provisions of this non-discrimination clause. The CONTRACTOR shall state that all qualified applicants will receive consideration for employment without regard to race, color, religion, sex, or national origin.
- 3) The CONTRACTOR will, in all solicitations or advertisements for employees placed by or on behalf of the CONTRACTOR, state that all qualified applicants will receive consideration for employment without regard to race, color, religion, sex or national origin.

JDPF
JDPF

WORR
WORR

- 4) The CONTRACTOR will send to each labor union or representative of workers with which he or she has a collective bargaining agreement or other contract or understanding, a notice, to be provided by the agency contracting officer, advising the labor union or workers representative of the CONTRACTOR's commitments under Section 202 of Executive Order 11246 of September 24, 1965, and shall post copies of the notice in conspicuous places available to employees and applicants for employment.
- 5) The CONTRACTOR will comply with all provisions of Executive Order 11246 of September 24, 1965, and of the rules, regulations and relevant orders of the Secretary of Labor.
- 6) The CONTRACTOR will furnish all information and reports required by Executive Order 11246 of September 24, 1965, and by the rules, regulations and orders of the Secretary of Labor, or pursuant thereto, and will permit access to books, records and accounts by the contracting agency and the Secretary of Labor for purposes of investigation to ascertain compliance with such rules, regulations and orders.
- 7) In the event of the CONTRACTOR's non-compliance with the non-discrimination clause of this Agreement or with any of such rules, regulations or orders, this Agreement may be cancelled, terminated or suspended in whole or in part and the CONTRACTOR may be declared ineligible for further government contracts in accordance with procedures authorized in Executive Order 11246 and such other sanctions as may be imposed and remedies invoked as provided in Executive Order 11246 of September 24, 1965, or by rule, regulation or order of the Secretary of Labor, or as otherwise provided by law.
- 8) CONTRACTOR shall incorporate the provisions of 1 through 7 above in every subcontract or purchase order unless exempted by rules, regulations or orders of the Secretary of Labor so that such provisions shall be binding on such subcontractor. The CONTRACTOR will take such action with respect to any subcontract or purchase order as the contracting agency may direct as a means of enforcing such provisions including sanctions for non-compliance, provided, however, that in the event the CONTRACTOR becomes involved in, or is threatened with, litigation with a subcontractor or vendor as a result of such direction by the contracting agency, the CONTRACTOR may request the United States to enter into such litigation to protect the interests of the United States.

JDPF
JDPF

WORR
WORR

25. CERTIFICATION OF NONSEGREGATED FACILITIES
(Applicable to construction contracts exceeding \$10,000)

The CONTRACTOR certifies that it does not maintain or provide for its establishments, and that it does not permit employees to perform their services at any location, under its control, where segregated facilities are maintained. It certifies further that it will not maintain or provide for employees any segregated facilities at any of its establishments, and it will not permit employees to perform their services at any location under its control where segregated facilities are maintained. The CONTRACTOR agrees that a breach of this certification is a violation of the equal opportunity clause of this Agreement.

As used in this certification, the term "segregated facilities" means any waiting rooms, work areas, rest rooms and wash rooms, restaurants and other eating areas, time clocks, locker rooms, and other storage or dressing areas, parking lots, drinking fountains, recreation or entertainment areas, transportation and housing facilities provided for employees which are segregated by explicit directive or are, in fact, segregated on the basis of race, color, religion, or national origin because of habit, local custom, or any other reason.

The CONTRACTOR further agrees that (except where it has obtained for specific time periods) it will obtain identical certification from proposed subcontractors prior to the award of subcontracts exceeding \$10,000 which are not exempt from the provisions of the equal opportunity clause; that it will retain such certifications in its files; and that it will forward the preceding notice to such proposed subcontractors (except where proposed subcontractors have submitted identical certifications for specific time periods).

26. CERTIFICATION OF COMPLIANCE WITH CLEAN AIR AND WATER ACTS
(Applicable to contracts exceeding \$100,000)

CLEAN AIR ACT

- 1)--The CONTRACTOR agrees to comply with all applicable standards, orders or regulations issued pursuant to the Clean Air Act, as amended, 42 U.S.C. § 7401 *et seq.*

- 2)--The CONTRACTOR agrees to report each violation to the PRDOH and understands and agrees that the PRDOH will, in turn, report each violation as required to assure notification to the Government of Puerto Rico, HUD, and the appropriate Environmental Protection Agency Regional Office.

JDPF
JDPF

WORR
WORR

- 3)--The CONTRACTOR agrees to include these requirements in each subcontract exceeding \$150,000 financed in whole or in part with Federal assistance provided by HUD.

WATER POLLUTION CONTROL ACT

- 1)--The CONTRACTOR agrees to comply with all applicable standards, orders or regulations issued pursuant to the Federal Water Pollution Control Act, as amended, 33 U.S.C. §1251, *et seq.*
- 2)--The CONTRACTOR agrees to report each violation to the PRDOH and understands and agrees that the PRDOH will, in turn, report each violation as required to assure notification to the Government of Puerto Rico, HUD, and the appropriate Environmental Protection Agency Regional Office.
- 3)--The CONTRACTOR agrees to include these requirements in each subcontract exceeding \$150,000 financed in whole or in part with Federal assistance provided by HUD.

The CONTRACTOR and all subcontractors shall comply with the requirements of the Clean Air Act, as amended, 42 U.S.C. § 7401 *et seq.*, the Federal Water Pollution Control Act, as amended, 33 U.S.C. § 1251 *et seq.*, and the regulations of the Environmental Protection Agency with respect thereto, at 40 C.F.R. Part 15 and 32, as amended, Section 508 of the Clean Water Act (33 U.S.C. § 1368) and Executive Order 11738.

In addition to the foregoing requirements, all nonexempt contractors and subcontractors shall furnish to the owner, the following:

- 1) A stipulation by the CONTRACTOR or subcontractors, that any facility to be utilized in the performance of any nonexempt contract or subcontract, is not listed on the Excluded Party Listing System pursuant to 40 C.F.R. Part 32 or on the List of Violating Facilities issued by the Environmental Protection Agency (**EPA**) pursuant to 40 C.F.R. Part 15, as amended.
- 2) Agreement by the CONTRACTOR to comply with all the requirements of Section 114 of the Clean Air Act, as amended, (42 U.S.C. § 7414) and Section 308 of the Federal Water Pollution Control Act, as amended, (33 U.S.C. § 1318) relating to inspection, monitoring, entry, reports and information, as well as all other requirements specified in said Section 114 and Section 308, and all regulations and guidelines issued thereunder.

JDPF
JDPF

WORR
WORR

- 3) A stipulation that as a condition for the award of the Agreement, prompt notice will be given of any notification received from the Director, Office of Federal Activities, EPA, indicating that a facility utilized, or to be utilized for the Agreement, is under consideration to be listed on the Excluded Party Listing System or the EPA List of Violating Facilities.
- 4) Agreement by the CONTRACTOR that he or she will include, or cause to be included, the criteria and requirements in paragraph (1) through (4) of this section in every nonexempt subcontract and requiring that the CONTRACTOR will take such action as the government may direct as a means of enforcing such provisions.

27. ANTI-LOBBYING (Applicable to contracts exceeding \$100,000)

By the execution of this Contract, the CONTRACTOR certifies, to the best of his or her knowledge and belief, that:

- 1) No Federal appropriated funds have been paid or will be paid, by or on behalf of the CONTRACTOR, to any person for influencing or attempting to influence an officer or employee of an agency, a Member of Congress, an officer or employee of Congress, or an employee of a Member of Congress in connection with the awarding of any Federal contract, the making of any Federal grant, the making of any Federal loan, the entering into of any cooperative agreement, and the extension, continuation, renewal, amendment, or modification of any Federal contract, grant, loan, or cooperative agreement.
- 2) If any funds other than Federal appropriated funds have been paid or will be paid to any person for influencing or attempting to influence an officer or employee of any agency, a Member of Congress, an officer or employee of Congress, or an employee of a Member of Congress in connection with this Federal contract, grant, loan, or cooperative agreement, the CONTRACTOR shall complete and submit Standard Form-LLL, "Disclosure of Lobbying Activities", in accordance with its instructions.
- 3) The CONTRACTOR shall require that the language of this certification be included in the award documents for all subawards at all tiers (including subcontracts, subgrants, and contracts under grants, loans, and cooperative agreements) and that all subrecipients shall certify and disclose accordingly.

This certification is a material representation of fact upon which reliance was placed when this transaction was made or entered into. Submission of this certification is a prerequisite for making or entering into this transaction imposed by Section 1352, Title

JDPF
JDPF

WORR
WORR

31, U.S. Code. Any person who fails to file the required certification shall be subject to a civil penalty of not less than \$10,000 and not more than \$100,000 for each such failure.

28. BONDING REQUIREMENTS

(Applicable to construction and facility improvement contracts exceeding \$100,000)

The CONTRACTOR shall comply with Puerto Rico bonding requirements, unless they have not been approved by HUD, in which case the CONTRACTOR shall comply with the following minimum bonding requirements:

- 1) A bid guarantee from each bidder equivalent to five percent (5%) of the bid price. The "bid guarantee" shall consist of a firm commitment such as a bid bond, certified check, or other negotiable instrument accompanying a bid as assurance that the bidder will, upon acceptance of his or her bid, execute such contractual documents as may be required within the time specified.
- 2) A performance bond on the part of the CONTRACTOR for one hundred percent (100%) of the Agreement price. A "performance bond" is one executed in connection with a contract to secure fulfillment of all the CONTRACTOR's obligations under such contract.
- 3) A payment bond on the part of the CONTRACTOR for one hundred percent (100%) of the Agreement price. A "payment bond" is one executed in connection with a contract to assure payment as required by law of all persons supplying labor and material in the execution of the work provided for in the contract.

29. SECTION 3 OF THE HOUSING AND URBAN DEVELOPMENT ACT OF 1968 (As required by applicable thresholds)

- 1) The work to be performed under this Agreement is subject to the requirements of Section 3 of the Housing and Urban Development Act of 1968, as amended, 12 U.S.C. § 1701u (**Section 3**). The purpose of Section 3 is to ensure that employment and other economic opportunities generated by HUD assistance or HUD-assisted projects covered by Section 3, shall, to the greatest extent feasible, be directed to low- and very low-income persons, particularly persons who are recipients of HUD assistance for housing.
- 2) The parties to this Agreement agree to comply with HUD's regulations in 24 C.F.R. Part 75 which implement Section 3. As evidenced by their execution of this Agreement,

JDPF
JDPF

WORR
WORR

the parties to this Agreement certify that they are under no contractual or other impediment that would prevent them from complying with the Part 75 regulations.

- 3) The CONTRACTOR agrees to send to each labor organization or representative of workers with which the CONTRACTOR has a collective bargaining agreement or other understanding, if any, a notice advising the labor organization or workers' representative of the CONTRACTOR's commitments under this Section 3 clause, and will post copies of the notice in conspicuous places at the work site where both employees and applicants for training and employment positions can see the notice. The notice shall describe the Section 3 preference, shall set forth minimum number and job titles subject to hire, availability of apprenticeship and training positions, the qualifications for each; and the name and location of the person(s) taking applications for each of the positions; and the anticipated date the work shall begin.
- 4) The CONTRACTOR agrees to include this Section 3 clause in every subcontract subject to compliance with regulations in 24 C.F.R. Part 75, and agrees to take appropriate action, as provided in an applicable provision of the subcontract or in this Section 3 clause, upon a finding that the subcontractor is in violation of the regulations in 24 C.F.R. Part 75. The CONTRACTOR will not subcontract with any subcontractor where the CONTRACTOR has notice or knowledge that the subcontractor has been found in violation of the regulations in 24 C.F.R. Part 75.
- 5) The CONTRACTOR will certify that any vacant employment positions, including training positions, that are filled: (1) after the CONTRACTOR is selected but before the contract is executed, and (2) with persons other than those to whom the regulations of 24 C.F.R. Part 75 require employment opportunities to be directed, were not filled to circumvent the CONTRACTOR's obligations under 24 C.F.R. Part 75.
- 6) Noncompliance with HUD's regulations in 24 C.F.R. Part 75 may result in sanctions, termination of this Agreement for default, and debarment or suspension from future HUD assisted contracts.
- 7) With respect to work performed in connection with Section 3 covered Indian housing assistance, Section 7(b) of the Indian Self-Determination and Education Assistance Act (46 U.S.C. § 5307) also applies to the work to be performed under this Agreement. Section 7(b) requires that to the greatest extent feasible: (i) preference and opportunities for training and employment shall be given to Indians, and (ii) preference in the award of contracts and subcontracts shall be given to Indian organizations and Indian-owned Economic Enterprises. Parties to this Agreement that are subject to the provisions of Section 3 and Section 7(b) agree to comply with

JDPF
JDPF

WORR
WORR

Section 3 to the maximum extent feasible, but not in derogation of compliance with Section 7(b).

- 8) For contracts exceeding \$100,000, the CONTRACTOR shall submit Form HUD 60002 (Section 3 Summary Report) to PRDOH on a quarterly basis, notwithstanding the annual reporting requirement set forth in that form's instructions.

30. FAIR HOUSING ACT

CONTRACTOR shall comply with the provisions of the Fair Housing Act of 1968, as amended. The act prohibits discrimination in the sale or rental of housing, the financing of housing or the provision of brokerage services against any person on the basis of race, color, religion, sex, national origin, handicap or familial status. The Equal Opportunity in Housing Act prohibits discrimination against individuals on the basis of race, color, religion, sex or national origin in the sale, rental, leasing or other disposition of residential property, or in the use or occupancy of housing assisted with Federal funds.

31. ENERGY POLICY AND CONSERVATION ACT

CONTRACTOR shall comply with mandatory standards and policies relating to energy efficiency as contained in the Government of Puerto Rico's energy conservation plan, issued in compliance with the Energy Policy and Conservation Act (42 U.S.C. 6201 *et seq.*).

32. HATCH ACT

CONTRACTOR agrees to comply with mandatory standards and policies relating to Hatch Act, Public Law 76-252, as amended.

The Hatch Act applies to political activities of certain state and local employees. As a Puerto Rico Department of Housing CONTRACTOR, you may do any of the following activities: be a candidate in nonpartisan elections; attend political meetings and conventions; contribute money; campaign in partisan elections; and hold office in political parties.

The CONTRACTOR may not do the following activities: be a candidate in partisan elections; use official influence to interfere in elections; coerce political contributions from subordinates in support of political parties or candidates. The office of special counsel operates a website that provides guidance concerning hatch act issues.

33. HEALTH AND SAFETY STANDARDS

All parties participating in this project agree to comply with Sections 107 and 103 of the Contract Work Hours and Safety Standards Act. Section 107 of the Act is applicable to construction work and provides that no laborer or mechanic shall be required to work in

JDPF
JDPF

WORR
WORR

surroundings or under working conditions, which are unsanitary, hazardous, or dangerous to his or her health and safety as determined under construction, safety, and health standards promulgated by the Secretary of Labor. These requirements do not apply to the purchase of supplies or materials or articles ordinarily available on the open market, or contracts for transportation.

34. PERSONNEL

The CONTRACTOR represents that it has, or will secure at its own expense, all personnel required in performing the services under this Agreement. Such personnel shall not be employees of, or have any contractual relationship with, the contracting party. All the services required hereunder will be performed by the CONTRACTOR or under its supervision, and all personnel engaged in the work shall be fully qualified and shall be authorized or permitted under State and local law to perform such services. No person who is serving sentence in a penal or correctional institution shall be employed on work under this Contract.

35. WITHHOLDING OF WAGES

If in the performance of this Agreement, there is any underpayment of wages by the CONTRACTOR or by any subcontractor thereunder, the PRDOH may withhold from the CONTRACTOR out of payment due to him or her an amount sufficient to pay to employees underpaid the difference between the wages required thereby to be paid and the wages actually paid such employees for the total number of hours worked. The amounts withheld may be disbursed by the PRDOH for and on account of the CONTRACTOR or subcontractor to the respective employees to whom they are due.

36. CLAIMS AND DISPUTES PERTAINING TO WAGE RATES

Claims and disputes pertaining to wage rates or to classifications of professional staff or technicians performing work under this Contract shall be promptly reported in writing by the CONTRACTOR to the PRDOH for the latter's decision, which shall be final with respect thereto.

37. DISCRIMINATION BECAUSE OF CERTAIN LABOR MATTERS

No person employed on the services covered by this Agreement shall be discharged or in any way discriminated against because he or she has filed any complaint or instituted or caused to be instituted any proceeding or has testified or is about to testify in any proceeding under or relating to the labor standards applicable hereunder to his or her employer.

38. INTEREST OF MEMBERS OF LOCAL PUBLIC AGENCY AND OTHERS

JDPF
JDPF

WORR
WORR

The CONTRACTOR agrees to establish safeguards to prohibit employees from using positions for a purpose that is or gives the appearance of being motivated by a desire for private gain for themselves or others, particularly those with whom they have a family, business, or other tie. The CONTRACTOR will be aware of and avoid any violation of the laws of this State which prohibit municipal officers and employees from having or owning any interest or share, individually or as agent or employee of any person or corporation, either directly or indirectly, in any contract made or let by the governing authorities of such municipality for the construction or doing of any public work, or for the sale or purchase of any materials, supplies or property of any description, or for any other purpose whatsoever, or in any subcontract arising therefrom or connected therewith, or to receive, either directly or indirectly, any portion or share of any money or other thing paid for the construction or doing of any public work, or for the sale or purchase of any property, or upon any other contract made by the governing authorities of the municipality, or subcontract arising therefore or connected therewith.

The CONTRACTOR will also be aware of and avoid any violation of the laws of this State which prescribe a criminal penalty for any public officer who has an interest in any contract passed by the board of which he or she is a member during the time he or she was a member and for one year thereafter.

39. INTEREST OF CERTAIN FEDERAL OFFICERS

No member of, or delegate to, the Congress of the United States and no Resident Commissioner shall be admitted any share or part of this Agreement or to any benefit to arise therefrom.

40. INTEREST OF CONTRACTOR

The CONTRACTOR agrees that it presently has no interest and shall not acquire any interest, direct or indirect, in the above described project or any parcels therein or any other interest which would conflict in any manner or degree with the performance of the Work hereunder. The CONTRACTOR further agrees that no person having any such interest shall be employed in the performance of this Agreement.

41. POLITICAL ACTIVITY

The CONTRACTOR will comply with the provisions of the Hatch Act (5 U.S.C. § 1501 et seq.), which limits the political activity of employees.

42. RELIGIOUS ACTIVITY

The CONTRACTOR agrees to abstain from using any funds related to this Agreement for inherently religious activities prohibited by 24 C.F.R. § 570.200(j), such as worship, religious instruction, or proselytization.

JDPF
JDPF

WORR
WORR

43. FLOOD DISASTER PROTECTION ACT OF 1973

The CONTRACTOR will ensure that procedures and mechanisms are put into place to monitor compliance with all flood insurance requirements as found in the Flood Disaster Protection Act of 1973, 24 C.F.R. § 570.605.

44. LEAD BASED PAINT

The CONTRACTOR must comply with the regulations regarding lead-based paint found at 24 C.F.R. Part 35 on LEAD-BASED PAINT POISONING PREVENTION IN CERTAIN RESIDENTIAL STRUCTURES with regards to all housing units assisted using CDBG-DR funds.

45. VALUE ENGINEERING

(Applicable to construction contracts exceeding \$2,000 when required by Federal program legislation)

The CONTRACTOR must comply with the regulations regarding systematic and organized approach to analyze functions of systems, equipment, facilities, services, and materials to ensure they achieve their essential functions at the lowest cost consistent to life cycle in execution, reliability, quality, and safety, in accordance with 24 C.F.R. § 200.318(g).

JDPF
JDPF

WORR
WORR

ATTACHMENT G

APPENDIX C CONTRACTOR CERTIFICATION FINANCIAL OVERSIGHT AND MANAGEMENT BOARD FOR PUERTO RICO CONTRACTS REVIEW POLICY

Carlbe Tecno, CRL

The following is hereby certified to the Oversight Board regarding the request for authorization for **Increased Capacity- PV Systems, Water Cisterns Acquisition and Installation Services for the Community Energy and Water Resilience Installation Services** contract by and between the **Puerto Rico Department of Housing and Carlbe Tecno, CRL:**

- JDPF*
JDPF
- WORR*
WORR
1. The expected contractor's subcontractor(s) in connection with the contract¹ is (are) the following:
 - Daky Electrical Services - Ruben Ramos
Electrical Work
Approximately: \$2,000,000.00
 2. Neither the contractor nor any of its owners², partners, directors, officials or employees, has agreed to share or give a percentage of the contractor's compensation under the contract to, or otherwise compensate, any third party, whether directly or indirectly, in connection with the procurement, negotiation, execution, or performance of the contract, except as follows:
N/A
 - (Name of individual or firm, including names or principals or owners of the latter)
 - (Principal terms and conditions of the compensation sharing agreement and consideration for such benefit)
 3. To the best knowledge of the signatory (after due investigation), no person has unduly intervened in the procurement, negotiation, or execution of the contract, for its own benefit or that of a third person, in contravention of applicable law.
 4. To the best knowledge of the signatory (after due investigation), no person has: (i) offered, paid, or promised to pay money to; (ii) offered, given, or

¹As used herein, the term "contract" is inclusive of any amendments, modifications or extensions.

²For purposes of this certification, a contractor's "owner" shall mean any person or entity with more than a ten percent (10%) ownership interest in the contractor.

promised to give anything of value to; or (iii) otherwise influenced any public official or employee with the purpose of securing any advantages, privileges, or favors for the benefit of such person in connection with the contract (such as the execution of a subcontract with contractor, beneficial treatment under the contract, or the written or unwritten promise of a gift, favor, or other monetary or non-monetary benefit.

5. Neither the contractor, nor any of its owners, partners, directors, officials or employees or, to the best of its knowledge (after due investigation), its representatives or sub-contractors, has required, directly or indirectly, from third persons to take any action with the purpose of influencing any public official or employee in connection with the procurement, negotiation, or execution of the contract.
6. Any incorrect, incomplete or false statement made by the contractor's representative as part of this certification shall cause the nullity of the proposed contract and the contractor must reimburse immediately to the Commonwealth any amounts, payments or benefits received from the Commonwealth under the proposed contract.

JDPF
JDPF

WORR
WORR

[The above certifications shall be signed under penalty of perjury by the Chief Executive Officer (or equivalent highest rank officer) in the following form:]

I hereby certify under penalty of perjury that the foregoing is complete, true, and correct.

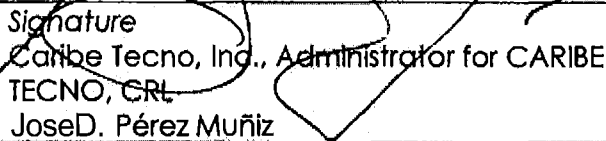

Signature
Caribe Tecno, Inc., Administrator for CARIBE
TECNO, CRL
Jose D. Pérez Muñiz

Printed Name

September 21, 2022

Date

President

Position



GOVERNMENT OF PUERTO RICO
DEPARTMENT OF HOUSING

ATTACHMENT H

GOVERNMENT OF PUERTO RICO

PROJECT LABOR AGREEMENT

BETWEEN

PUERTO RICO DEPARTMENT OF HOUSING (PRDOH)

AND

CARIBE TECNO, CRL

ARTICLE 1. —LEGAL BASIS

This Project Labor Agreement (hereinafter, "Agreement") is hereby adopted in accordance and in compliance with Section 3 of Administrative Bulletin No. OE-2018-033, titled "Executive Order of the Governor of Puerto Rico, Hon. Ricardo A. Rosselló Nevares, to increase minimum wage for construction workers, implement laws that require the use of cement produced in Puerto Rico, and require the use of labor agreements in construction projects paid using public funds", enacted on July 30, 2018 (hereinafter, "OE-2018-033").

ARTICLE 2. —PURPOSE

The Government of Puerto Rico wishes to contribute to the economic welfare of construction workers, increase peace in the workplace and employee safety, and promote efficient and punctual performance of the Construction Project, as defined in Article 4 of this Agreement, in such a way that complies with the public policy set forth in OE-2018-033. In accordance with Section 4 of OE-2018-033, this Agreement shall promote these objectives and it exclusively: binds all contractors and subcontractors who participate in the Construction Project; contains tools to avoid interruptions based on labor disputes; promotes harmony in the workplace; provides uniform mechanisms to solve labor conflicts, and increases cooperation between contractors and workers in matters related to productivity and occupational safety.

ARTICLE 3. —PARTIES TO THE AGREEMENT

This document is a Project Labor Agreement entered into by Puerto Rico Department of Housing (PRDOH), as agency of the Executive Branch of the Government of Puerto Rico (hereinafter, "Agency"), and Caribe Tecno, CRL as a contractor who employs construction workers for the Construction Project (hereinafter, "Contractor"). Project Labor Agreement (AGENCY AND CONTRACTOR)

ARTICLE 4. —CONSTRUCTION PROJECT

The Construction Project (hereinafter, "Construction Project") is described in the Agreement between PRDOH and the Contractor, to which this Project Labor Agreement is an attachment of.

JDPF
JDPF

WORR
WORR

ARTICLE 5. —RESPONSIBILITIES AND OBLIGATIONS OF THE PARTIES

This Agreement shall be binding on the Agency and on all Contractors at all levels who are part of the Construction Project, as defined in OE-2018-033 and Circular Letter No. 2018-01 of the Department of Labor and Human Resources (hereinafter, "DTRH" for its Spanish acronym). Contractors shall include a clause in any subcontract entered into during the term of this Agreement to the effect that their subcontractors, on all levels, shall be parties that are governed by this Agreement as to any work subcontracted within the scope of the Construction Project. Furthermore, all Contractors and subcontractors who are a part of the Construction Project, as defined in OE-2018-033 and DTRH Circular Letter No. 2018-01, shall include a clause in the contract in which they agree to comply with the provisions of this Agreement.

The Agency shall not be responsible for any violation of this Agreement. The Agency and any Contractor shall not be liable for violations to this Agreement committed by other Contractors. Liability of any Contractor under this Agreement shall be individual and shall not be joint liability ("mancomunada", in Spanish). The Agency and any Contractor shall not be liable for violations to this Agreement committed by another Contractor. It is further provided that the Contractor shall be responsible for compensating workers hired by subcontractors who did not comply with the minimum wage requirement.

Nothing in this Article shall limit the exclusive discretion of the Agency to determine what Contractor to award contracts to for the Construction Project. The Agency retains the authority to totally or partially cancel, delay, or suspend the Construction Project.

In addition to the provisions of this Agreement, in the event that there is a collective bargaining agreement between the Contractor and an exclusive union representative of its employees, or a certification of a relevant forum establishing a labor union as the exclusive union representative of the workers or group of workers for the Contractor, the liability of the latter shall be governed as expressly agreed in the appropriate collective bargaining agreement and/or relevant case law of the National Labor Relations Board.

ARTICLE 6. —WAGES

All workers covered by this Agreement shall be paid a wage of no less than fifteen dollars (\$15.00) per hour, in accordance with OE-2018-033, DTRH Circular Letter No. 2018-01 and Article 9 of this Agreement. In the event that the worker is entitled to earn a wage greater than what is contemplated under OE-2018-033, due to some federal or state law, the contractor and subcontractors shall be required to pay the higher wage. The Contractor shall put up the poster made by the DTRH as to minimum wage established under OE-2018-033 in a visible location in the Construction Project. It is further provided that the classification of a person as independent contractor shall not, in and of itself, be grounds to avoid the minimum wage provided under OE-2018-033.

As provided by Section 3 of Law No. 17 enacted on April 17, 1931, as amended, known as "Wage Payment Law", workers shall receive compensation either in cash,

JDPF
JDPF

WORR
WORR

by check, direct deposit, transfer, or credit to a payroll card, in intervals that shall not exceed fifteen (15) days. When a worker is terminated or resigns from his or her job during any day of the week, the Contractor shall pay the amount for the number of days worked, no later than the next official pay day in the manner agreed upon.

If the provisions of Law No. 379 enacted on May 15, 1948, as amended, known as the "Law to Establish Work Hours in Puerto Rico", is applicable because there is no collective bargaining agreement in effect negotiated by a labor organization, the Contractor shall provide each worker with a pay stub containing the following information: name and address of the Contractor, name of the employee, position, dates and period of work covered by the payment, total regular hours and overtime, salary earned for regular hours and overtime; additions and deductions, indicating the reasons therefor; and the net amount received by the worker. The employer shall provide, within five (5) calendar days subsequent to payment, a check stub through a method that guarantees delivery in accordance with Article XV of DTRH Regulation No. 9017 enacted on April 4, 2018, "Regulations to Administer Law No. 379 enacted on May 15, 1948, as amended, known as the 'Law to Establish Work Hours in Puerto Rico'".

The Parties reaffirm their policy of non-discrimination in the workplace based on any of the reasons prohibited by law, as well as public policy, intended to promote equal pay for equal work in accordance with Law 16-2017, "Puerto Rico Equal Salary Act," and Law 61-2017. Furthermore, the Contractor acknowledges that he or she has consulted the "Uniform Guidelines for Self-Study as to Equal Salary in the Workplace" of August 10, 2017, in order to make any internal assessment to corroborate that it does not engage in salary discrimination of its employees based on sex.

Every other aspect of the legislation and federal and state regulations regarding how minimum wage is paid and what is considered to be work hours or time shall be applicable.

ARTICLE 7. —PROCEEDINGS BEFORE THE LABOR AND HUMAN RESOURCES DEPARTMENT

Any worker covered by this Agreement, by the provisions of OE-2018-033 and by DTRH Circular Letter No. 2018-01, who alleges a violation of the wage provisions may contact the DTRH's Work Regulations Bureau to report the violation. The DTRH shall initiate an expedited process to hear these claims for prompt decision in accordance with the Secretary's Memorandum No. 2018-05.

The Contractor shall cooperate with the Investigators of the Work Regulations Bureau and with any other employee or officer granted authority by the Secretary of the DTRH to investigate these claims. Furthermore, the Contractor shall be required to deliver payroll documents, a copy of the contracts or any other documents requested by said employees and/or officers with delegated authority.

In accordance with Law 115-1991, as amended, the Contractor shall not be able to terminate, threaten, or discriminate against any worker in relation to the terms, conditions, compensation, location, benefits, or privileges of employment based on the worker offering or attempting to offer any verbal or written testimony, statement or information, related to the rights given by the OE-2018-033, before the DTRH or any

JDPF
JDPF

WORR
WORR

other judicial, administrative, or legislative forum, if said statements are not defamatory or constitute a disclosure of privileged information established by law.

Nothing provided in this Article prevents workers from turning to the courts to enforce their rights, request any other legal remedies that are necessary to enforce the terms of the OE-2018-033, and compel compliance with the rules, orders, and determinations issued by the Secretary of the DTRH in the exercise of the powers given to the same under it.

ARTICLE 8. —DISPUTE RESOLUTION

The Contractor, as well as any other subcontractor, must take affirmative steps to solve labor controversies in order to avoid, but not prohibit, cessation of work, strikes, stoppages, or closures, which could put at risk the timely conclusion of the Construction Project. If, after attempting to solve the controversy internally, any of these conflicts materializes, both the Agency and the Contractor agree to notify the DTRH within a period of forty-eight (48) hours from conclusion of the internal resolution attempts. The DTRH shall send a DTRH mediator or arbitrator, within a period of two (2) business days from notice to the same, who shall attempt to solve the situation. The alternative conflict resolution process before the DTRH shall have priority and must be concluded within thirty (30) days from designation of the mediator or arbitrator.

Nothing provided in this Article prevents the parties from turning to any other judicial, administrative, or legislative forum to enforce their rights.

ARTICLE 9. —SAFETY AND PROTECTION REQUIREMENTS

At the Construction Project site, each Contractor must comply with and maintain the current safety requirements in accordance with the applicable state and federal rules and regulations, including the ones promulgated by the Puerto Rico Occupational Safety and Health Administration ("PR OSHA"), an entity under the DTRH.

Within sixty (60) days of signing the agreement, the Contractor must contact PR OSHA to request training regarding the occupational safety and health standards which must be implemented during the course of the Construction Project.

Furthermore, each Contractor must make sure that non-skillful workers ("obreros no-diestros" in Spanish) participate in training programs regarding subjects that are relevant to the construction industry, related to construction codes, safety, permits, among others, in accordance with the procedures and guidelines issued by the Office of Management and Permits of the Government of Puerto Rico ("OGPe," for its acronym in Spanish) in this regard. Compliance with said training programs shall be an indispensable requirement for non-skillful workers to be able to continue earning the minimum salary of fifteen dollars (\$15.00) per hour provided in the OE-2018-033 and interpreted in DTRH Circular Letter No. 2018-01. It shall be the responsibility of each Contractor to comply with the duties and guidelines issued by the OGPe in this regard.

JDPF
JDPF

WORR
WORR

ARTICLE 10. —UNIONS

The implementation of the provisions of this Agreement shall not be considered as the recognition by the Contractor or the Agency of a labor union as the exclusive union representative of any group of employees at the shop, in accordance with Section 9 of the OE-2018-033.

In the event that there is a collective bargaining agreement between the Contractor and an exclusive union representative of its employees, or a certification from a relevant forum establishing a labor union as the exclusive union representative of the workers or group of workers of the Contractor, it shall be the responsibility of the latter to negotiate work conditions and the controversy resolution process with the union representative. Therefore, the relationship between the Contractor and the workers shall be governed by the specific agreements in the corresponding collective bargaining agreement and/or relevant case law of the National Labor Relations Board, in all parts and sections that are not incompatible with the Agreement.

ARTICLE 11. —APPLICABILITY TO EMPLOYEES

The provisions of this agreement apply to all (skillful or non-skillful ("diestro o no diestro", in Spanish) construction workers who perform manual or physical duties in the Construction Project, as defined in the OE-2018-033 and the DTRH Circular Letter No. 2018-01. The following persons are not subject to the provisions of this Agreement, even if they perform Construction Project duties:

- a. "Professionals", "executives", and "administrators", as defined by the Regulations of the DTRH No. 7082 dated January 18, 2006, known as "Regulation Number 13 — Fifth Revision (2005)."
- b. Employees who do not directly perform manual or physical duties in the Construction Project, only performing duties in connection to public work, such as: security/surveillance area monitors, timekeepers, mailpersons, office works, secretaries, messengers, guards, accounting duties (payroll, bookkeeping), technicians, receptionists, switchboard operators, electronic data processing, record keepers, and other analogous duties, and all other employees who only perform administrative duties.
- c. Employees of the Agency, or of any other state entity, even if they work at the Construction Project site while it is in progress.

ARTICLE 12. —APPLICABILITY TO ENTITIES

This Agreement shall be available and shall be fully applied to any winning bidder for the Construction Project who becomes the signer of the same, regardless of whether or not it performs work in other projects. This Agreement shall not apply to the work of any Contractor performed in other projects. Furthermore, it shall not apply to the headquarters, subsidiaries, or affiliates of any Contractor, which does not participate in the Construction Project directly.

Work conditions under this Agreement shall not apply to the Agency, nor to any other public entity, and nothing contained in this document shall be interpreted to prohibit its employees from working in or outside of the Construction Project location.

JDPF
JDPF

WORR
WORR

ARTICLE 13. —SEVERABILITY

If any part of this Agreement is nullified, found to violate the law, or to potentially result in the loss of all or part of the Construction Project financing, it shall be considered temporarily or permanently null and void. However, the rest of the Agreement shall remain in full force and effect to the extent allowed by law. It is the express and unequivocal will of the Parties that the corresponding forums enforce the provisions and the application of this Agreement to the greatest extent possible, even if any part of it, or its application to any person or circumstance, is revoked, nullified, invalidated, affected, or declared unconstitutional.

ARTICLE 14. —EXCLUSIVITY OF AGREEMENTS

This document contains the only agreements of all signers in relation to the labor conditions governing the Construction Project and replace any other agreement between the parties regarding labor conditions which would otherwise completely or partially apply to the Construction Project. It shall not be required for any Contractor to execute another agreement regarding labor conditions as a requirement to carry out Construction Project.

ARTICLE 15. —EFFECTIVE PERIOD

This Agreement shall come into effect immediately upon being approved and signed by (1) the Agency appointing authority and (2) the Contractor. It is understood that this Agreement, along with all of its provisions, shall remain in effect for the entire Construction Project until it is concluded, even if it is not completed before the agreement expiration date.

AND SINCE THEY ARE IN AGREEMENT AS TO THE FOREGOING, the parties sign this Agreement on December 19, 2022.

PUERTO RICO DEPARTMENT OF HOUSING

CARIBE TECNO, CRL

William O. Rodríguez Rodríguez
William O. Rodríguez Rodríguez (Dec 19, 2022 16:35 AST)

William O. Rodríguez Rodríguez, Esq.,
Secretary

José D. Pérez Fernández
José D. Pérez Fernández (Dec 15, 2022 18:26 AST)

José D. Pérez Fernández
Authorized Representative

A. APPLICABILITY

The Project or Program to which the construction work covered by this Contract pertains is being assisted by the United States of America, and the following Federal Labor Standards Provisions are included in this Contract pursuant to the provisions applicable to such Federal assistance.

(1) MINIMUM WAGES

- (i) All laborers and mechanics employed or working upon the site of the work will be paid unconditionally and not less often than once a week, and without subsequent deduction or rebate on any account (except such payroll deductions as are permitted by regulations issued by the Secretary of Labor under the Copeland Act (29 CFR Part 3)), the full amount of wages and bona fide fringe benefits (or cash equivalents thereof) due at time of payment, computed at rates not less than those contained in the wage determination of the Secretary of Labor (which is attached hereto and made a part hereof), regardless of any contractual relationship which may be alleged to exist between the contractor and such laborers and mechanics. Contributions made or costs reasonably anticipated for bona fide fringe benefits under Section 1(b)(2) of the Davis-Bacon Act on behalf of laborers or mechanics are considered wages paid to such laborers or mechanics, subject to the provisions of 29 CFR 5.5(a)(1)(iv); also, regular contributions made or costs incurred for more than a weekly period (but not less often than quarterly) under plans, funds, or programs, which cover the particular weekly period, are deemed to be constructively made or incurred during such weekly period.

Such laborers and mechanics shall be paid the appropriate wage rate and fringe benefits on the wage determination for the classification of work actually performed, without regard to skill, except as provided in 29 CFR 5.5(a)(4). Laborers or mechanics performing work in more than one classification may be compensated at the rate specified for each classification for the time actually worked therein: Provided, that the employer's payroll records accurately set forth the time spent in each classification in which work is performed. The wage determination (including any additional classification and wage rates conformed under 29 CFR 5.5(a)(1)(ii) and the Davis-Bacon poster (WH1321)) shall be posted at all times by the contractor and its subcontractors at the site of the work in a prominent and accessible place, where it can be easily seen by the workers.

(ii) Additional Classifications.

- (A) Any class of laborers or mechanics which is not listed in the wage determination and which is to be employed under the contract shall be classified in conformance with the wage determination. HUD shall approve an additional classification and wage rate and fringe benefits therefor only when the following criteria have been met:
- (1) The work to be performed by the classification requested is not performed by a classification in the wage determination;
 - (2) The classification is utilized in the area by the construction industry; and
 - (3) The proposed wage rate, including any bona fide fringe benefits, bears a reasonable relationship to the wage rates contained in the wage determination.
- (B) If the contractor, the laborers and mechanics to be employed in the classification (if known), or their representatives, and HUD or its designee agree on the proposed classification and wage rate (including the amount designated for fringe benefits, where appropriate), a report of the action taken shall be sent by HUD or its designee to the Administrator of the Wage and Hour Division ("Administrator"), Employment Standards Administration, U.S. Department of Labor, Washington, D.C. 20210. The Administrator, or an authorized representative, will approve, modify, or disapprove every additional classification action within 30 days of receipt and so advise HUD or its designee or will notify HUD or its designee within the 30-day period that additional time is necessary. (Approved by the Office of Management and Budget ("OMB") under OMB control number 1235-0023.)
- (C) In the event the contractor, the laborers or mechanics to be employed in the classification or their representatives, or HUD or its designee do not agree on the proposed classification and wage rate (including the amount designated for fringe benefits, where appropriate), HUD or its designee shall refer the questions, including the views of all interested parties and the recommendation of HUD or its designee, to the Administrator for determination. The Administrator, or an authorized representative, will issue a determination within 30 days of receipt and so advise HUD or its designee or will notify HUD or its designee within the 30-day period that additional time is necessary. (Approved by the Office of Management and Budget under OMB Control Number 1235-0023.)

JDPF
JDPF

WORR
WORR

(D) The wage rate (including fringe benefits, where appropriate) determined pursuant to subparagraphs (1)(ii)(B) or (C) of this paragraph, shall be paid to all workers performing work in the classification under this Contract from the first day on which work is performed in the classification.

(iii) Whenever the minimum wage rate prescribed in the contract for a class of laborers or mechanics includes a fringe benefit which is not expressed as an hourly rate, the contractor shall either pay the benefit as stated in the wage determination or shall pay another bona fide fringe benefit or an hourly cash equivalent thereof.

(iv) If the contractor does not make payments to a trustee or other third person, the contractor may consider as part of the wages of any laborer or mechanic the amount of any costs reasonably anticipated in providing bona fide fringe benefits under a plan or program, Provided, that the Secretary of Labor has found, upon the written request of the contractor, that the applicable standards of the Davis-Bacon Act have been met. The Secretary of Labor may require the contractor to set aside in a separate account assets for the meeting of obligations under the plan or program. (Approved by the Office of Management and Budget under OMB Control Number 1235-0023.)

(2) **Withholding.** HUD or its designee shall, upon its own action or upon written request of an authorized representative of the U.S. Department of Labor, withhold or cause to be withheld from the contractor under this contract or any other Federal contract with the same prime contractor, or any other Federally-assisted contract subject to Davis-Bacon prevailing wage requirements which is held by the same prime contractor, so much of the accrued payments or advances as may be considered necessary to pay laborers and mechanics, including apprentices, trainees and helpers, employed by the contractor or any subcontractor the full amount of wages required by the contract. In the event of failure to pay any laborer or mechanic, including any apprentice, trainee or helper, employed or working on the site of the work, all or part of the wages required by the contract, HUD or its designee may, after written notice to the contractor, sponsor, applicant, or owner, take such action as may be necessary to cause the suspension of any further payment, advance, or guarantee of funds until such violations have ceased. HUD or its designee may, after written notice to the contractor, disburse such amounts withheld for and on account of the contractor or subcontractor to the respective employees to whom they are due. The U.S. Department of Labor shall make such disbursements in the case of direct Davis-Bacon Act contracts.

(3) **Payrolls and basic records.**

(i) **Maintaining Payroll Records.** Payrolls and basic records relating thereto shall be maintained by the contractor during the course of the work and preserved for a period of three years thereafter for all laborers and mechanics working at the site of the work. Such records shall contain the name, address, and social security number of each such worker, his or her correct classification(s), hourly rates of wages paid (including rates of contributions or costs anticipated for bona fide fringe benefits or cash equivalents thereof of the types described in Section 1(b)(2)(B) of the Davis-Bacon Act), daily and weekly number of hours worked, deductions made, and actual wages paid.

Whenever the Secretary of Labor has found, under 29 CFR 5.5(a)(1)(iv), that the wages of any laborer or mechanic include the amount of any costs reasonably anticipated in providing benefits under a plan or program described in Section 1(b)(2)(B) of the Davis-Bacon Act, the contractor shall maintain records which show that the commitment to provide such benefits is enforceable, that the plan or program is financially responsible, and that the plan or program has been communicated in writing to the laborers or mechanics affected, and records which show the costs anticipated or the actual cost incurred in providing such benefits.

Contractors employing apprentices or trainees under approved programs shall maintain written evidence of the registration of apprenticeship programs and certification of trainee programs, the registration of the apprentices and trainees, and the ratios and wage rates prescribed in the applicable programs. (Approved by the Office of Management and Budget under OMB Control Numbers 1235-0023 and 1215-0018)

(ii) **Certified Payroll Reports.**

(A) The contractor shall submit weekly, for each week in which any contract work is performed, a copy of all payrolls to HUD or its designee if the agency is a party to the contract, but if the agency is not such a party, the contractor will submit the payrolls to the applicant sponsor, or owner, as the case may be, for transmission to HUD or its designee. The payrolls submitted shall set out accurately and completely all of the information required to be maintained under 29 CFR 5.5(a)(3)(i), except that full social security numbers and home addresses shall not be included on weekly transmittals. Instead, the payrolls only need to include an individually identifying number for each employee (e.g., the last four digits of the employee's social security number). The required weekly payroll information may be submitted in any form desired. Optional Form WH-347 is available for this purpose from the Wage and Hour Division Web site at <https://www.dol.gov/agencies/whd/forms> or its successor site. The prime contractor is responsible for the submission of copies of payrolls by all subcontractors.

JDPF
JDPF

WORR
WORR

Contractors and subcontractors shall maintain the full social security number and current address of each covered worker, and shall provide them upon request to HUD or its designee if the agency is a party to the contract, but if the agency is not such a party, the contractor will submit the payrolls to the applicant sponsor, or owner, as the case may be, for transmission to HUD or its designee, the contractor, or the Wage and Hour Division of the U.S. Department of Labor for purposes of an investigation or audit of compliance with prevailing wage requirements. It is not a violation of this subparagraph for a prime contractor to require a subcontractor to provide addresses and social security numbers to the prime contractor for its own records, without weekly submission to HUD or its designee. (Approved by the Office of Management and Budget under OMB Control Number 1235-0008.)

- (B) Each payroll submitted shall be accompanied by a "Statement of Compliance," signed by the contractor or subcontractor or his or her agent who pays or supervises the payment of the persons employed under the contract and shall certify the following:
- (1) That the payroll for the payroll period contains the information required to be provided under 29 CFR 5.5(a)(3)(ii), the appropriate information is being maintained under 29 CFR 5.5(a)(3)(i), and that such information is correct and complete;
 - (2) That each laborer or mechanic (including each helper, apprentice, and trainee) employed on the contract during the payroll period has been paid the full weekly wages earned, without rebate, either directly or indirectly, and that no deductions have been made either directly or indirectly from the full wages earned, other than permissible deductions as set forth in 29 CFR Part 3;
 - (3) That each laborer or mechanic has been paid not less than the applicable wage rates and fringe benefits or cash equivalents for the classification of work performed, as specified in the applicable wage determination incorporated into the contract; and
- (C) The weekly submission of a properly executed certification set forth on the reverse side of Optional Form WH-347 shall satisfy the requirement for submission of the "Statement of Compliance" required by subparagraph (a)(3)(ii)(b).
- (D) The falsification of any of the above certifications may subject the contractor or subcontractor to civil or criminal prosecution under Section 1001 of Title 18 and Section 3729 of Title 31 of the United States Code.

(iii) The contractor or subcontractor shall make the records required under subparagraph (a)(3)(i) available for inspection, copying, or transcription by authorized representatives of HUD or its designee or the U.S. Department of Labor, and shall permit such representatives to interview employees during working hours on the job. If the contractor or subcontractor fails to submit the required records or to make them available, HUD or its designee may, after written notice to the contractor, sponsor, applicant, or owner, take such action as may be necessary to cause the suspension of any further payment, advance, or guarantee of funds. Furthermore, failure to submit the required records upon request or to make such records available may be grounds for debarment action pursuant to 29 CFR 5.12.

(4) Apprentices and Trainees.

- (i) **Apprentices.** Apprentices will be permitted to work at less than the predetermined rate for the work they performed when they are employed pursuant to and individually registered in a bona fide apprenticeship program registered with the U.S. Department of Labor, Employment and Training Administration, Office of Apprenticeship Training, Employer and Labor Services, or with a State Apprenticeship Agency recognized by the Office, or if a person is employed in his or her first 90 days of probationary employment as an apprentice in such an apprenticeship program, who is not individually registered in the program, but who has been certified by the Office of Apprenticeship Training, Employer and Labor Services, or a State Apprenticeship Agency (where appropriate), to be eligible for probationary employment as an apprentice.

The allowable ratio of apprentices to journeymen on the job site in any craft classification shall not be greater than the ratio permitted to the contractor as to the entire work force under the registered program. Any worker listed on a payroll at an apprentice wage rate, who is not registered or otherwise employed as stated above, shall be paid not less than the applicable wage rate on the wage determination for the classification of work actually performed. In addition, any apprentice performing work on the job site in excess of the ratio permitted under the registered program shall be paid not less than the applicable wage rate on the wage determination for the work actually performed. Where a contractor is performing construction on a project in a locality other than that in which its program is registered, the ratios and wage rates (expressed in percentages of the journeyman's hourly rate) specified in the contractor's or subcontractor's registered program shall be observed.

Every apprentice must be paid at not less than the rate specified in the registered program for the apprentice's level of progress, expressed as a percentage of the journeymen hourly rate specified in the applicable wage determination. Apprentices shall be paid fringe benefits in accordance with the provisions of the apprenticeship program.

If the apprenticeship program does not specify fringe benefits, apprentices must be paid the full amount of fringe benefits listed on the wage determination for the applicable classification. If the Administrator determines that a different practice prevails for the applicable apprentice classification, fringe benefits shall be paid in accordance with that determination. In the event the Office of Apprenticeship Training, Employer and Labor Services, or a State Apprenticeship Agency recognized by the Office, withdraws approval of an apprenticeship program, the contractor will no longer be permitted to utilize apprentices at less than the applicable predetermined rate for the work performed until an acceptable program is approved.

- (ii) **Trainees.** Except as provided in 29 CFR 5.16, trainees will not be permitted to work at less than the predetermined rate for the work performed, unless they are employed pursuant to and individually registered in a program which has received prior approval, evidenced by formal certification by the U.S. Department of Labor, Employment and Training Administration. The ratio of trainees to journeymen on the job site shall not be greater than permitted under the plan approved by the Employment and Training Administration. Every trainee must be paid at not less than the rate specified in the approved program for the trainee's level of progress, expressed as a percentage of the journeyman hourly rate specified in the applicable wage determination. Trainees shall be paid fringe benefits in accordance with the provisions of the trainee program. If the trainee program does not mention fringe benefits, trainees shall be paid the full amount of fringe benefits listed on the wage determination unless the Administrator of the Wage and Hour Division determines that there is an apprenticeship program associated with the corresponding journeyman wage rate on the wage determination which provides for less than full fringe benefits for apprentices. Any employee listed on the payroll at a trainee rate who is not registered and participating in a training plan approved by the Employment and Training Administration shall be paid not less than the applicable wage rate on the wage determination for the work actually performed.

In addition, any trainee performing work on the job site in excess of the ratio permitted under the registered program shall be paid not less than the applicable wage rate on the wage determination for the work actually performed. In the event the Employment and Training Administration withdraws approval of a training program, the contractor will no longer be permitted to utilize trainees at less than the applicable predetermined rate for the work performed until an acceptable program is approved.

- (iii) **Equal employment opportunity.** The utilization of apprentices, trainees, and journeymen under 29 CFR Part 5 shall be in conformity with the equal employment opportunity requirements of Executive Order 11246, as amended, and 29 CFR Part 30.

- (5) **Compliance with Copeland Act requirements.** The contractor shall comply with the requirements of 29 CFR Part 3, which are incorporated by reference in this Contract.
- (6) **Subcontracts.** The contractor or subcontractor will insert in any subcontracts the clauses contained in subparagraphs (1) through (11) in this paragraph (a) and such other clauses as HUD or its designee may, by appropriate instructions, require, and a copy of the applicable prevailing wage decision, and also a clause requiring the subcontractors to include these clauses in any lower tier subcontracts. The prime contractor shall be responsible for the compliance by any subcontractor or lower tier subcontractor with all the contract clauses in this paragraph.
- (7) **Contract termination; debarment.** A breach of the contract clauses in 29 CFR 5.5 may be grounds for termination of the contract and for debarment as a contractor and a subcontractor as provided in 29 CFR 5.12.
- (8) **Compliance with Davis-Bacon and Related Act Requirements.** All rulings and interpretations of the Davis-Bacon and Related Acts contained in 29 CFR Parts 1, 3, and 5 are herein incorporated by reference in this Contract.
- (9) **Disputes concerning labor standards.** Disputes arising out of the labor standards provisions of this Contract shall not be subject to the general disputes clause of this Contract. Such disputes shall be resolved in accordance with the procedures of the U.S. Department of Labor set forth in 29 CFR Parts 5, 6, and 7. Disputes within the meaning of this clause include disputes between the contractor (or any of its subcontractors) and HUD or its designee, the U.S. Department of Labor, or the employees or their representatives.
- (10) **Certification of Eligibility.**
- (i) By entering into this Contract, the contractor certifies that neither it (nor he or she) nor any person or firm who has an interest in the contractor's firm is a person or firm ineligible to be awarded Government contracts by virtue of Section 3(a) of the Davis-Bacon Act or 29 CFR 5.12(a)(1) or to be awarded HUD contracts or participate in HUD programs pursuant to 24 CFR Part 24.

JDPF
JDPF

WORR
WORR

(ii) No part of this Contract shall be subcontracted to any person or firm ineligible for award of a Government contract by virtue of Section 3(a) of the Davis-Bacon Act or 29 CFR 5.12(a)(1) or to be awarded HUD contracts or participate in HUD programs pursuant to 24 CFR Part 24.

(iii) Anyone who knowingly makes, presents, or submits a false, fictitious, or fraudulent statement, representation or certification is subject to criminal, civil and/or administrative sanctions, including fines, penalties, and imprisonment (e.g., 18 U.S.C. §§ 287, 1001, 1010, 1012; 31 U.S.C. §§ 3729, 3802).

(11) Complaints, Proceedings, or Testimony by Employees. No laborer or mechanic, to whom the wage, salary, or other labor standards provisions of this Contract are applicable, shall be discharged or in any other manner discriminated against by the contractor or any subcontractor because such employee has filed any complaint or instituted or caused to be instituted any proceeding or has testified or is about to testify in any proceeding under or relating to the labor standards applicable under this Contract to his employer.

B. CONTRACT WORK HOURS AND SAFETY STANDARDS ACT

The provisions of this paragraph (b) are applicable where the amount of the prime contract exceeds **\$100,000**. As used in this paragraph, the terms "laborers" and "mechanics" include watchmen and guards.

(1) Overtime requirements. No contractor or subcontractor contracting for any part of the contract work, which may require or involve the employment of laborers or mechanics, shall require or permit any such laborer or mechanic in any workweek in which the individual is employed on such work to work in excess of 40 hours in such workweek, unless such laborer or mechanic receives compensation at a rate not less than one and one-half times the basic rate of pay for all hours worked in excess of 40 hours in such workweek.

(2) Violation; liability for unpaid wages; liquidated damages. In the event of any violation of the clause set forth in subparagraph B(1) of this paragraph, the contractor, and any subcontractor responsible therefor, shall be liable for the unpaid wages. In addition, such contractor and subcontractor shall be liable to the United States (in the case of work done under contract for the District of Columbia or a territory, to such District or to such territory) for liquidated damages. Such liquidated damages shall be computed with respect to each individual laborer or mechanic, including watchmen and guards, employed in violation of the clause set forth in subparagraph B(1) of this paragraph, **in the sum set by the U.S. Department of Labor at 29 CFR 5.5(b)(2)** for each calendar day on which such individual was required or permitted to work in excess of the standard workweek of 40 hours without payment of the overtime wages required by the clause set forth in subparagraph B(1) of this paragraph. In accordance with the Federal Civil Penalties Inflation Adjustment Act of 1990 (28 U.S.C. § 2461 Note), the DOL adjusts this civil monetary penalty for inflation no later than January 15 each year.

(3) Withholding for unpaid wages and liquidated damages. HUD or its designee shall, upon its own action or upon written request of an authorized representative of the U.S. Department of Labor, withhold or cause to be withheld from any moneys payable on account of work performed by the contractor or subcontractor under any such contract, or any other Federal contract with the same prime contract, or any other Federally-assisted contract subject to the Contract Work Hours and Safety Standards Act which is held by the same prime contractor, such sums as may be determined to be necessary to satisfy any liabilities of such contractor or subcontractor for unpaid wages and liquidated damages, as provided in the clause set forth in subparagraph B(2) of this paragraph.

(4) Subcontracts. The contractor or subcontractor shall insert in any subcontracts the clauses set forth in subparagraph B(1) through (4) of this paragraph and also a clause requiring the subcontractors to include these clauses in any lower tier subcontracts. The prime contractor shall be responsible for compliance by any subcontractor or lower tier subcontractor with the clauses set forth in subparagraphs B(1) through (4) of this paragraph.

C. HEALTH AND SAFETY

The provisions of this paragraph (c) are applicable where the amount of the prime contract exceeds **\$100,000**.

(1) No laborer or mechanic shall be required to work in surroundings or under working conditions which are unsanitary, hazardous, or dangerous to his or her health and safety, as determined under construction safety and health standards promulgated by the Secretary of Labor by regulation.

(2) The contractor shall comply with all regulations issued by the Secretary of Labor pursuant to 29 CFR Part 1926 and failure to comply may result in imposition of sanctions pursuant to the Contract Work Hours and Safety Standards Act, (Public Law 91-54, 83 Stat 96), 40 U.S.C. § 3701 et seq.

(3) The contractor shall include the provisions of this paragraph in every subcontract, so that such provisions will be binding on each subcontractor. The contractor shall take such action with respect to any subcontractor as the Secretary of Housing and Urban Development or the Secretary of Labor shall direct as a means of enforcing such provisions.

A. APLICABILIDAD

El Proyecto o Programa al que se refiere el trabajo de construcción cubierto por este Contrato está siendo asistido por los Estados Unidos de América, y las siguientes Disposiciones de Normas Laborales Federales están incluidas en este Contrato de conformidad con las disposiciones aplicables a dicha asistencia federal.

(1) SALARIOS MÍNIMOS

- (i) Todos los trabajadores y mecánicos empleados o que trabajen en el sitio del trabajo serán pagados incondicionalmente y con una frecuencia no inferior a una vez por semana, y sin deducciones o descuentos subsiguientes en ninguna cuenta (excepto las deducciones de nómina permitidas por los reglamentos emitidos por el Secretario de Trabajo en virtud de la Ley Copeland (29 CFR Parte 3)), el monto total de los salarios y los beneficios complementarios de buena fe (o sus equivalentes en efectivo) adeudados al momento del pago, calculados a tasas no inferiores a las contenidas en la determinación del salario del Secretaría del Trabajo (que se adjunta al presente y forma parte del mismo), independientemente de cualquier relación contractual que pueda alegarse que existe entre el contratista y dichos trabajadores y mecánicos. Las contribuciones hechas o los costos razonablemente anticipados por beneficios complementarios de buena fe bajo la Sección 1(b)(2) de la Ley Davis-Bacon en nombre de trabajadores o mecánicos se consideran salarios pagados a dichos trabajadores o mecánicos, sujeto a las disposiciones de 29 CFR 5.5 (a)(1)(iv); también, las contribuciones periódicas realizadas o los costos incurridos durante más de un período semanal (pero con una frecuencia no inferior a la trimestral) en virtud de planes, fondos o programas que cubran el período semanal en particular, se considerarán realizados o incurridos de manera constructiva durante dicho período semanal.

Dichos trabajadores y mecánicos recibirán el salario correspondiente y los beneficios complementarios según la determinación del salario para la clasificación del trabajo realmente realizado, sin tener en cuenta la habilidad, excepto según lo dispuesto en 29 CFR 5.5(a)(4).

Los trabajadores o mecánicos que realicen trabajos en más de una clasificación podrán ser compensados a la tarifa especificada para cada clasificación por el tiempo realmente trabajado en la misma: Siempre que los registros de nómina del empleador establezcan con precisión el tiempo empleado en cada clasificación en la que se realiza el trabajo. El contratista y sus subcontratistas deberán publicar en todo momento la determinación del salario (incluida cualquier clasificación adicional y tarifas salariales conforme a 29 CFR 5.5(a)(1)(ii) y el cartel de Davis-Bacon (WH1321)) en el sitio de la obra en un lugar visible y accesible, donde los trabajadores puedan verla fácilmente.

(ii) Clasificaciones Adicionales.

- (A) Cualquier clase de trabajadores o mecánicos que no figuren en la determinación del salario y que deban emplearse en virtud del contrato se clasificarán de conformidad con la determinación del salario. HUD aprobará una clasificación adicional y una tasa de salario y beneficios complementarios solo cuando se cumplan los siguientes criterios:

- (1) El trabajo para realizar por la clasificación solicitada no es realizado por una clasificación en la determinación del salario;
- (2) La clasificación es utilizada en el área por la industria de la construcción; y
- (3) La tasa salarial propuesta, incluidos los beneficios complementarios de buena fe, tiene una relación razonable con las tasas salariales contenidas en la determinación del salario.

- (B) Si el contratista, los trabajadores y los mecánicos que se emplearán en la clasificación (si se conocen), o sus representantes, y HUD o su designado acuerdan la clasificación propuesta y la tarifa salarial (incluida la cantidad designada para beneficios complementarios, cuando corresponda), HUD o su designado enviará un informe de la acción tomada al Administrador de la División de Horas y Salarios ("Administrador"), Administración de Normas Laborales, Departamento de Trabajo de EE. UU., Washington, D.C. 20210. El Administrador, o un representante autorizado, aprobará, modificará o desaprobará cada acción de clasificación adicional dentro de los 30 días posteriores a la recepción y así informará a HUD o su designado o notificará a HUD o su designado dentro del período de 30 días que se requiere de tiempo adicional. (Aprobado por la Oficina de Gerencia y Presupuesto ("OMB") bajo el número de control OMB 1235-0023).

- (C) En caso de que el contratista, los trabajadores o mecánicos que se emplearán en la clasificación o sus

JDPF
JDPF

WORR
WORR

representantes, o HUD o su designado no estén de acuerdo con la clasificación propuesta y la tarifa salarial (incluida la cantidad designada para beneficios complementarios, cuando corresponda), HUD o su designado remitirá las preguntas, incluidas las opiniones de todas las partes interesadas y la recomendación de HUD o su designado, al Administrador para su determinación. El Administrador, o un representante autorizado, emitirá una determinación dentro de los 30 días posteriores a la recepción y así informará a HUD o su designado o notificará a HUD o su designado dentro del período de 30 días que se necesita tiempo adicional. (Aprobado por la Oficina de Gerencia y Presupuesto bajo el Número de Control OMB 1235-0023).

(D) El salario (incluidos los beneficios complementarios, cuando corresponda) determinado de conformidad con los subpárrafos (1)(ii)(B) o (C) de este párrafo, se pagará a todos los trabajadores que realicen trabajos en la clasificación conforme a este Contrato desde el primer día en que se realiza el trabajo en la clasificación.

(iii) Siempre que la tasa de salario mínimo prescrita en el contrato para una clase de trabajadores o mecánicos incluya un beneficio adicional que no se exprese como una tarifa por hora, el contratista deberá pagar el beneficio según se establece en la determinación del salario o deberá pagar otro bono beneficio marginal de buena fe o un equivalente en efectivo por hora del mismo.

(iv) Si el contratista no realiza pagos a un fideicomisario u otra tercera persona, el contratista puede considerar como parte de los salarios de cualquier trabajador o mecánico el monto de cualquier costo razonable anticipado al proporcionar beneficios complementarios de buena fe bajo un plan o programa, siempre que la Secretaría del Trabajo haya determinado, previa solicitud por escrito del contratista, que se han cumplido las normas aplicables de la Ley Davis-Bacon. La Secretaría del Trabajo podrá requerir al contratista que aparte en una cuenta separada activos para el cumplimiento de las obligaciones bajo el plan o programa. (Aprobado por la Oficina de Gerencia y Presupuesto bajo el Número de Control OMB 1235-0023).

(2) **Retenciones.** HUD o su designado deberá, por su propia acción o por solicitud por escrito de un representante autorizado del Departamento de Trabajo de EE. UU., retener o hacer que se retenga del contratista en virtud de este contrato o cualquier otro contrato federal con el mismo contratista principal, o cualquier otro contrato con asistencia federal sujeto a los requisitos de salario prevaleciente de Davis-Bacon que esté en manos del mismo contratista principal, tanto de los pagos o anticipos devengados según se considere necesario para pagar a los trabajadores y mecánicos, incluidos los aprendices, personas en entrenamiento y ayudantes, empleados por el contratista o cualquier subcontratista, el monto total de los salarios requeridos por el contrato. En caso de que no se pague a cualquier trabajador o mecánico, incluido cualquier aprendiz, persona en entrenamiento o ayudante, empleados o que trabaje en el sitio de trabajo, la totalidad o parte de los salarios requeridos por el contrato, HUD o su designado puede, después de un aviso por escrito al contratista, patrocinador, solicitante o propietario, tomar las medidas que sean necesarias para provocar la suspensión de cualquier otro pago, adelanto o garantía de fondos hasta que tales violaciones hayan cesado. HUD o su designado puede, después de una notificación por escrito al contratista, desembolsar dichos montos retenidos por y a cuenta del contratista o subcontratista a los respectivos empleados a quienes se les adeuda. El Departamento de Trabajo de los Estados Unidos hará tales desembolsos en el caso de contratos directos de la Ley Davis-Bacon.

(3) Nóminas y registros básicos.

(i) **Mantenimiento de registros de nómina.** Las nóminas y los registros básicos relacionados con las mismas deberán ser mantenidos por el contratista durante el curso del trabajo y conservados por un período de tres años a partir de entonces para todos los trabajadores y mecánicos que laboren en el sitio del trabajo. Dichos registros deberán contener el nombre, la dirección y el número de seguro social de cada trabajador, su(s) clasificación(es) correcta(s), las tarifas por hora de los salarios pagados (incluidas las tasas de contribuciones o los costos previstos para los beneficios complementarios de buena fe o los equivalentes en efectivo de los mismos de los tipos descritos en la Sección 1(b)(2)(B) de la Ley Davis-Bacon), el número de horas diarias y semanales trabajadas, las deducciones realizadas y los salarios reales pagados.

Siempre que la Secretaría del Trabajo haya determinado, conforme a 29 CFR 5.5(a)(1)(iv), que los salarios de cualquier trabajador o mecánico incluyen el monto de cualquier costo anticipado razonablemente al brindar beneficios bajo un plan o programa descrito en la Sección 1(b)(2)(B) de la Ley Davis-Bacon, el contratista deberá mantener registros que demuestren que el compromiso de proporcionar dichos beneficios es exigible, que el plan o programa es financieramente responsable y que el plan o programa ha sido comunicados por escrito a los trabajadores o mecánicos afectados, y registros que muestren los costos previstos o el costo real incurrido en la prestación de dichos beneficios.

Los contratistas que empleen aprendices o personas en entrenamiento bajo programas aprobados deberán mantener evidencia escrita del registro de los programas de aprendices y la certificación de los programas de aprendizaje, el

JDPF
JDPF

WOPR
WOPR

registro de los aprendices y personas en entrenamiento, y las proporciones y tarifas salariales prescritas en los programas aplicables. (Aprobado por la Oficina de Gerencia y Presupuesto bajo los Números de Control OMB 1235-0023 y 1215-0018)

(ii) Informes Certificados de Nómina.

(A) El contratista deberá presentar semanalmente, por cada semana en la que se realice cualquier trabajo por contrato, una copia de todas las nóminas a HUD o su designado si la agencia es una parte del contrato, pero si la agencia no es tal parte, el contratista enviará las nóminas al patrocinador solicitante o propietario, según sea el caso, para su transmisión a HUD o a su designado. Las nóminas enviadas deberán establecer de manera precisa y completa toda la información que se requiere mantener según 29 CFR 5.5(a)(3)(i), exceptuando los números de seguro social completos y las direcciones de las casas que no se incluirán en las transmisiones semanales. En cambio, las nóminas solo deben incluir un número de identificación individual para cada empleado (por ejemplo, los últimos cuatro dígitos del número de seguro social del empleado). La información de nómina semanal requerida se puede enviar en cualquier forma deseada. El formulario opcional WH-347 está disponible para este propósito en el sitio web de la División de Horas y Salarios en <https://www.dol.gov/agencies/whd/forms> o en su sitio sucesor. El contratista primario es responsable de la presentación de copias de las nóminas por parte de todos los subcontratistas.

Los contratistas y subcontratistas deberán mantener el número de seguro social completo y la dirección actual de cada trabajador cubierto, y deberán proporcionarlos a pedido del HUD o su designado si la agencia es una parte del contrato, pero si la agencia no es tal parte, el contratista enviará las nóminas al patrocinador solicitante o al propietario, según sea el caso, para que las transmita al HUD o su designado, al contratista o a la División de Horas y Salarios del Departamento de Trabajo de los EE. UU. para fines de una investigación o auditoría de cumplimiento de los requisitos salariales vigentes. No es una violación de este subpárrafo que un contratista principal requiera que un subcontratista proporcione direcciones y números de seguro social al contratista principal para sus propios registros, sin la presentación semanal al HUD o su designado. (Aprobado por la Oficina de Gerencia y Presupuesto bajo el Número de Control OMB 1235-0008).

- (B)** Cada nómina presentada deberá estar acompañada de una "Declaración de Cumplimiento", firmada por el contratista o subcontratista o su agente que paga o supervisa el pago de las personas empleadas bajo el contrato y deberá certificar lo siguiente:
- (1)** Que la nómina para el período de nómina contiene la información que debe proporcionarse según 29 CFR 5.5(a)(3)(ii), la información adecuada se mantiene según 29 CFR 5.5(a)(3)(i), y que dicha información es correcta y completa;
 - (2)** Que a cada trabajador o mecánico (incluido cada ayudante, aprendiz y persona en entrenamiento) empleado bajo contrato durante el período de nómina se le haya pagado el salario semanal completo que haya ganado, sin descuento, ya sea directa o indirectamente, y que no se hayan hecho deducciones ya sea directa o indirectamente de los salarios completos ganados, que no sean las deducciones permitidas según lo establecido en 29 CFR Parte 3;
 - (3)** Que a cada trabajador o mecánico se le haya pagado no menos de las tasas salariales aplicables y beneficios marginales o equivalentes en efectivo para la clasificación del trabajo realizado, como se especifica en la determinación salarial aplicable incorporada en el contrato; y
- (C)** La presentación semanal de una certificación debidamente ejecutada establecida en el reverso del formulario opcional WH-347 que cumpla con el requisito de presentación de la "Declaración de cumplimiento" requerida por el subpárrafo (a)(3)(ii)(b).
- (D)** La falsificación de cualquiera de las certificaciones anteriores puede someter al contratista o subcontratista a un proceso civil o penal conforme a la Sección 1001 del Título 18 y la Sección 3729 del Título 31 del Código de los Estados Unidos.

(iii) El contratista o subcontratista deberá hacer que los registros requeridos bajo el subpárrafo (a)(3)(i) estén disponibles para inspección, copia o transcripción por parte de representantes autorizados de HUD o su designado o del Departamento del Trabajo de los EE. UU., y permitirá a tales representantes entrevistar a los empleados durante las horas de trabajo estando en el trabajo. Si el contratista o subcontratista no presenta los registros requeridos o no los pone a disposición, HUD o su designado puede, después de notificar por escrito al contratista, patrocinador, solicitante o propietario, tomar las medidas que sean necesarias para provocar la suspensión de cualquier pago adicional, anticipo o garantía de fondos. Además, la falta de presentación de los registros requeridos a petición o de no poner dichos registros a disposición puede ser motivo de acción de inhabilitación de conformidad con 29 CFR 5.12.

(4) Aprendices y Personas en entrenamiento.

- (i) **Aprendices.** A los aprendices se les permitirá trabajar a una tarifa inferior a la predeterminada por el trabajo que realizaron cuando estén empleados de conformidad con un programa de aprendizaje de buena fe registrado individualmente en el Departamento del Trabajo de los EE. UU., Administración de Empleo y Capacitación, Oficina de Capacitación de Aprendices, Servicios Laborales y de Empleadores, o con una Agencia Estatal de Aprendizaje reconocida por la Oficina, o si una persona está empleada en sus primeros 90 días de empleo a prueba como aprendiz en dicho programa de aprendizaje, que no está registrado individualmente en el programa, pero que ha sido certificado por la Oficina de Capacitación de Aprendices, Servicios Laborales y de Empleadores, o una Agencia Estatal de Aprendices (cuando corresponda), para ser elegible para un empleo de prueba como aprendiz.

La proporción permitida de aprendices a jornaleros en el sitio de trabajo en cualquier clasificación de oficio no será mayor que la proporción permitida al contratista en cuanto a la fuerza de trabajo total bajo el programa registrado. Cualquier trabajador que figure en una nómina con una tasa de salario de aprendiz, que no esté registrado o empleado de otra manera como se indicó anteriormente, recibirá un pago no inferior a la tasa de salario aplicable en la determinación del salario para la clasificación del trabajo realmente realizado. Además, cualquier aprendiz que realice un trabajo en el sitio de trabajo que exceda la proporción permitida por el programa registrado deberá recibir un pago no inferior al salario aplicable en la determinación del salario por el trabajo realmente realizado. Cuando un contratista esté realizando la construcción de un proyecto en una localidad distinta a la que tiene registrado su programa, se observarán las proporciones y tarifas salariales (expresadas en porcentajes de la tarifa por hora del jornalero) especificadas en el programa registrado del contratista o subcontratista.

A cada aprendiz se le debe pagar a un nivel no menor a la tarifa especificada en el programa registrado para el nivel de progreso del aprendiz, expresada como un porcentaje de la tarifa por hora del jornalero especificada en la determinación salarial aplicable.

Los aprendices recibirán beneficios complementarios de acuerdo con las disposiciones del programa de aprendizaje.

Si el programa de aprendizaje no especifica los beneficios complementarios, los aprendices deben recibir el monto total de los beneficios complementarios que figuran en la determinación del salario para la clasificación aplicable. Si el Administrador determina que prevalece una práctica diferente para la clasificación de aprendiz aplicable, los beneficios complementarios se pagarán de acuerdo con esa determinación. En caso de que la Oficina de Capacitación de Aprendices, Servicios Laborales y de Empleadores, o una Agencia Estatal de Aprendices reconocida por la Oficina, retire la aprobación de un programa de aprendices, el contratista ya no podrá utilizar aprendices a una tarifa inferior a la predeterminada aplicable para el trabajo realizado hasta que se apruebe un programa aceptable.

- (ii) **Personas en entrenamiento.** Salvo lo dispuesto en 29 CFR 5.16, no se permitirá que las personas en entrenamiento trabajen a una tarifa inferior a la predeterminada por el trabajo realizado, a menos que estén empleados de conformidad con un programa que haya recibido aprobación previa, evidenciado por una certificación formal del Departamento de Trabajo, Administración de Empleo y Capacitación de EE. UU. La proporción de personas en entrenamiento a jornaleros en el lugar de trabajo no será mayor que lo permitido según el plan aprobado por la Administración de Empleo y Capacitación. A cada persona en entrenamiento se le debe pagar a no menos de la tarifa especificada en el programa aprobado para el nivel de progreso de la persona en entrenamiento, expresada como un porcentaje de la tarifa por hora especificada del jornalero en la determinación salarial aplicable. Las personas en entrenamiento recibirán beneficios complementarios de acuerdo con las disposiciones del programa de aprendices. Si el programa de entrenamiento no menciona los beneficios complementarios, a las personas en entrenamiento se les pagará el monto total de los beneficios complementarios enumerados en la determinación del salario, a menos que el Administrador de la División de Horas y Salarios determine que existe un programa de aprendizaje asociado con la tasa salarial del oficial correspondiente en la determinación del salario que prevé menos de los beneficios complementarios completos para los aprendices. Cualquier empleado que figure en la nómina con una tarifa de persona en entrenamiento que no esté registrado y que no participe en un plan de capacitación aprobado por la Administración de Empleo y Capacitación recibirá un pago no inferior al salario aplicable en la determinación del salario por el trabajo realmente realizado.

Además, a cualquier persona en entrenamiento que realice labores en el sitio de trabajo que exceda la proporción permitida por el programa registrado se le pagará no menos que la tarifa salarial aplicable en la determinación del salario por el trabajo realmente realizado. En caso de que la Administración de Empleo y Capacitación retire la aprobación de un programa de capacitación, el contratista ya no podrá utilizar personas en entrenamiento a una tarifa inferior a la predeterminada aplicable para el trabajo realizado hasta que se apruebe un programa aceptable.

- (iii) **Igualdad de oportunidades de empleo.** La utilización de aprendices, personas en entrenamiento y jornaleros bajo 29 CFR Parte 5 deberá estar en conformidad con los requisitos de igualdad de oportunidades de empleo de la Orden

JDPF
JDPF

WORR
WORR

Ejecutiva 11246, enmendada, y 29 CFR Parte 30.

- (5) **Cumplimiento de los requisitos de la Ley Copeland.** El contratista deberá cumplir con los requisitos de 29 CFR Parte 3, que se incorporan por referencia en este Contrato.
- (6) **Subcontratos.** El contratista o subcontratista insertará en cualquier subcontrato las cláusulas contenidas de los subpárrafos (1) al (11) en este párrafo (a) y cualquier otra cláusula que HUD o su designado pueda requerir, mediante las instrucciones apropiadas, y una copia de la correspondiente decisión sobre el salario prevaleciente, y también una cláusula que requiere que los subcontratistas incluyan estas cláusulas en cualquier subcontrato de nivel inferior. El contratista principal será responsable del cumplimiento por parte de cualquier subcontratista o subcontratista de nivel inferior de todas las cláusulas del contrato en este párrafo.
- (7) **Terminación del contrato; exclusión.** El incumplimiento de las cláusulas del contrato en 29 CFR 5.5 puede ser motivo de rescisión del contrato y de inhabilitación como contratista y subcontratista según lo dispuesto en 29 CFR 5.12.
- (8) **Cumplimiento con los Requisitos de la Ley Davis-Bacon y Leyes Relacionadas.** Todos los fallos e interpretaciones de Davis-Bacon y Actos Relacionados contenidos en 29 CFR Partes 1, 3 y 5 se incorporan aquí por referencia en este Contrato.
- (9) **Controversias relativas a las normas laborales.** Las disputas que surjan de las disposiciones sobre normas laborales de este Contrato no estarán sujetas a la cláusula general de disputas de este Contrato. Dichas disputas se resolverán de acuerdo con los procedimientos del Departamento de Trabajo de los EE. UU. establecidos en 29 CFR Partes 5, 6 y 7. Las disputas dentro del significado de esta cláusula incluyen disputas entre el contratista (o cualquiera de sus subcontratistas) y HUD o su designado, el Departamento de Trabajo de los Estados Unidos, o los empleados o sus representantes.
- (10) **Certificación de la elegibilidad.**
- (i) Al celebrar este Contrato, el contratista certifica que ni él (ni él o ella) ni ninguna persona o firma que tenga un interés en la firma del contratista es una persona o firma inelegible para adjudicarse contratos del Gobierno en virtud de la Sección 3 (a) de la Ley Davis-Bacon o 29 CFR 5.12(a)(1) o para recibir contratos de HUD o participar en programas de HUD de conformidad con 24 CFR Parte 24.
 - (ii) Ninguna parte de este Contrato se subcontratará a ninguna persona o firma que no sea elegible para la adjudicación de un contrato del Gobierno en virtud de la Sección 3(a) de la Ley Davis-Bacon o 29 CFR 5.12(a)(1) o para ser adjudicado contratos de HUD o participar en programas de HUD de conformidad con 24 CFR Parte 24.
 - (iii) Cualquier persona que a sabiendas haga, presente o envíe una declaración, representación o certificación falsa, ficticia o fraudulenta está sujeta a sanciones penales, civiles y/o administrativas, incluidas multas, sanciones y encarcelamiento (p. ej., 18 U.S.C. §§ 287, 1001, 1010, 1012, 31 USC §§ 3729, 3802).
- (11) **Quejas, Procedimientos o Testimonio de los Empleados.** Ningún trabajador o mecánico, a quien se apliquen las disposiciones sobre sueldos, salarios u otras normas laborales de este Contrato, será despedido o discriminado de ninguna otra manera por parte del contratista o cualquier subcontratista porque dicho empleado haya presentado una queja o instituido o causado a haber iniciado cualquier procedimiento o ha declarado o está a punto de declarar en cualquier procedimiento bajo o relacionado con las normas laborales aplicables en virtud de este Contrato a su empleador.

B. LEY DE NORMAS DE SEGURIDAD Y HORAS DE TRABAJO POR CONTRATO

Las disposiciones de este párrafo (b) se aplican cuando el monto del contrato principal excede los \$100,000. Tal como se usa en este párrafo, los términos "obreros" y "mecánicos" incluyen vigilantes y guardias.

- (1) **Requisitos de horas extras.** Ningún contratista o subcontratista que contrate para cualquier parte del trabajo del contrato, que pueda requerir o involucrar el empleo de trabajadores o mecánicos, requerirá o permitirá que dicho trabajador o mecánico en cualquier semana laboral en la que el individuo esté empleado en dicho trabajo trabaje en exceso de 40 horas en dicha semana laboral, a menos que dicho trabajador o mecánico reciba una compensación a una tasa no inferior a una vez y media la tasa básica de pago por todas las horas trabajadas en exceso de 40 horas en dicha semana laboral.
- (2) **Violación; responsabilidad por salarios no pagados; daños y perjuicios.** En caso de cualquier violación de la cláusula establecida en el inciso B (1) de este párrafo, el contratista, y cualquier subcontratista responsable por ello, será responsable por los salarios no pagados. Además, dicho contratista y subcontratista serán responsables ante los Estados Unidos (en el caso de trabajos realizados bajo contrato para el Distrito de Columbia o un territorio, ante dicho Distrito o territorio) por daños y perjuicios. Dichos daños y perjuicios se calcularán con respecto a cada trabajador o mecánico individual, incluidos los vigilantes y guardias, empleados en violación de la cláusula establecida en el subpárrafo B(1) de este párrafo, en la suma establecida por el Departamento de Trabajo de los EE. UU. en 29 CFR 5.5(b)(2) por cada día calendario en el que se requirió o permitió que dicha persona trabajara más de la semana laboral estándar de 40 horas sin

el pago de los salarios por horas extras requeridos por la cláusula establecida en el subpárrafo B(1) de este párrafo. De acuerdo con la Ley Federal de Ajuste de Sanciones Civiles por Inflación de 1990 (28 U.S.C. § 2461 Note), el DOL ajusta esta sanción monetaria civil por inflación a más tardar el 15 de enero de cada año.

- (3) **Retención por salarios no pagados y daños y perjuicios.** HUD o su designado deberá, por su propia acción o previa solicitud por escrito de un representante autorizado del Departamento de Trabajo de los EE. UU., retener o hacer que se retenga cualquier dinero pagadero a cuenta del trabajo realizado por el contratista o subcontratista en virtud de dicho contrato, o cualquier otro contrato federal con el mismo contrato principal, o cualquier otro contrato con asistencia federal sujeto a la Ley de estándares de seguridad y horas de trabajo por contrato que esté en manos del mismo contratista principal, las sumas que se determinen como necesarias para satisfacer cualquier responsabilidad de dicho contratista o subcontratista por salarios no pagados y daños y perjuicios, según lo dispuesto en la cláusula establecida en el subpárrafo B(2) de este párrafo.
- (4) **Subcontratos.** El contratista o subcontratista insertará en cualquier subcontrato las cláusulas establecidas en el subpárrafo B (1) a (4) de este párrafo y también una cláusula que requiera que los subcontratistas incluyan estas cláusulas en cualquier subcontrato de nivel inferior. El contratista principal será responsable del cumplimiento por parte de cualquier subcontratista o subcontratista de nivel inferior de las cláusulas establecidas en los subpárrafos B (1) a (4) de este párrafo.

JDPFC.
JDPF

SALUD Y SEGURIDAD

Las disposiciones de este párrafo (c) se aplican cuando el monto del contrato principal excede los **\$100,000**.

- (1) No se le exigirá a ningún trabajador o mecánico que trabaje en un entorno o en condiciones de trabajo insalubres, riesgosas o peligrosas para su salud y seguridad, según lo determinen las normas de seguridad y salud en la construcción promulgadas por la Secretaría del Trabajo mediante reglamentos.
- (2) El contratista deberá cumplir con todos los reglamentos emitidos por el la Secretaria del Trabajo de conformidad con 29 CFR Parte 1926 y el incumplimiento puede resultar en la imposición de sanciones de conformidad con la Ley de Normas de Seguridad y Horas de Trabajo por Contrato, (Ley Pública 91-54, 83 Stat 96), 40 U.S.C. § 3701 y siguientes.
- (3) El contratista deberá incluir las disposiciones de este párrafo en cada subcontrato, de modo que dichas disposiciones sean vinculantes para cada subcontratista. El contratista tomará las medidas con respecto a cualquier subcontratista que la Secretaría de Vivienda y Desarrollo Urbano o la Secretaría del Trabajo indiquen como un medio para hacer cumplir dichas disposiciones.

WORR
WORR

ATTACHMENT J

"General Decision Number: PR20220003 02/25/2022

Superseded General Decision Number: PR20210003

State: Puerto Rico

Construction Type: Residential

Counties: Puerto Rico Statewide.

RESIDENTIAL CONSTRUCTION PROJECTS (consisting of single family homes and apartments up to and including 4 stories)

Note: Contracts subject to the Davis-Bacon Act are generally required to pay at least the applicable minimum wage rate required under Executive Order 14026. Please note that this Executive Order applies to covered contracts entered into by the federal government that are subject to the Davis-Bacon Act itself, but does not apply to contracts subject only to the Davis-Bacon Related Acts, including those set forth at 29 CFR 5.1(a)(2)-(60).

JDPF
JDPF

WORR
WORR

<p>If the contract is entered into on or after January 30, 2022, or the contract is renewed or extended (e.g., an option is exercised) on or after January 30, 2022:</p>	<ul style="list-style-type: none"> . Executive Order 14026 generally applies to the contract. . The contractor must pay all covered workers at least \$15.00 per hour (or the applicable wage rate listed on this wage determination, if it is higher) for all hours spent performing on the contract in 2022.
--	--

The applicable Executive Order minimum wage rate will be adjusted annually. If this contract is covered by one of the Executive Orders and a classification considered necessary for performance of work on the contract does not appear on this wage determination, the contractor must still submit a conformance request.

Additional information on contractor requirements and worker protections under the Executive Orders is available at <https://www.dol.gov/agencies/whd/government-contracts>.

Modification Number	Publication Date
0	01/07/2022
1	02/25/2022

* SUPR1993-002 10/29/1993

	Rates	Fringes
CARPENTER.....	\$ 7.25 **	.65
CEMENT MASON/CONCRETE FINISHER...	\$ 7.25 **	
ELECTRICIAN.....	\$ 7.25 **	.64
IRONWORKER.....	\$ 7.25 **	.63

Laborer, Unskilled.....\$ 7.25 ** .36
 PAINTER.....\$ 7.25 **
 PLUMBER.....\$ 7.25 ** .56
 Power equipment operators:
 Cranes.....\$ 7.25 ** 1.14
 Diggers.....\$ 7.25 **
 TRUCK DRIVER.....\$ 7.25 **

 WELDERS - Receive rate prescribed for craft performing operation to which welding is incidental.

=====

JDPF ** Workers in this classification may be entitled to a higher minimum wage under Executive Order 14026 (\$15.00). Please see the Note at the top of the wage determination for more information.
JDPF

WORRU Unlisted classifications needed for work not included within the scope of the classifications listed may be added after award only as provided in the labor standards contract clauses (29CFR 5.5 (a) (1) (ii)).
WORRU

The body of each wage determination lists the classification and wage rates that have been found to be prevailing for the cited type(s) of construction in the area covered by the wage determination. The classifications are listed in alphabetical order of ""identifiers"" that indicate whether the particular rate is a union rate (current union negotiated rate for local), a survey rate (weighted average rate) or a union average rate (weighted union average rate).

Union Rate Identifiers

A four letter classification abbreviation identifier enclosed in dotted lines beginning with characters other than ""SU"" or ""UAVG"" denotes that the union classification and rate were prevailing for that classification in the survey. Example: PLUM0198-005 07/01/2014. PLUM is an abbreviation identifier of the union which prevailed in the survey for this classification, which in this example would be Plumbers. 0198 indicates the local union number or district council number where applicable, i.e., Plumbers Local 0198. The next number, 005 in the example, is an internal number used in processing the wage determination. 07/01/2014 is the effective date of the most current negotiated rate, which in this example is July 1, 2014.

Union prevailing wage rates are updated to reflect all rate changes in the collective bargaining agreement (CBA) governing this classification and rate.

Survey Rate Identifiers

Classifications listed under the ""SU"" identifier indicate that

no one rate prevailed for this classification in the survey and the published rate is derived by computing a weighted average rate based on all the rates reported in the survey for that classification. As this weighted average rate includes all rates reported in the survey, it may include both union and non-union rates. Example: SULA2012-007 5/13/2014. SU indicates the rates are survey rates based on a weighted average calculation of rates and are not majority rates. LA indicates the State of Louisiana. 2012 is the year of survey on which these classifications and rates are based. The next number, 007 in the example, is an internal number used in producing the wage determination. 5/13/2014 indicates the survey completion date for the classifications and rates under that identifier.

Survey wage rates are not updated and remain in effect until a new survey is conducted.

Union Average Rate Identifiers

JDPF
JDPF classification(s) listed under the UAVG identifier indicate that no single majority rate prevailed for those classifications; however, 100% of the data reported for the classifications was union data. EXAMPLE: UAVG-OH-0010 08/29/2014. UAVG indicates that the rate is a weighted union average rate. OH indicates the state. The next number, 0010 in the example, is an internal number used in producing the wage determination. 08/29/2014 indicates the survey completion date for the classifications and rates under that identifier.

WORR
WORR

A UAVG rate will be updated once a year, usually in January of each year, to reflect a weighted average of the current negotiated/CBA rate of the union locals from which the rate is based.

WAGE DETERMINATION APPEALS PROCESS

1.) Has there been an initial decision in the matter? This can be:

- * an existing published wage determination
- * a survey underlying a wage determination
- * a Wage and Hour Division letter setting forth a position on a wage determination matter
- * a conformance (additional classification and rate) ruling

On survey related matters, initial contact, including requests for summaries of surveys, should be with the Wage and Hour National Office because National Office has responsibility for the Davis-Bacon survey program. If the response from this initial contact is not satisfactory, then the process described in 2.) and 3.) should be followed.

With regard to any other matter not yet ripe for the formal process described here, initial contact should be with the Branch of Construction Wage Determinations. Write to:

Branch of Construction Wage Determinations
Wage and Hour Division
U.S. Department of Labor
200 Constitution Avenue, N.W.
Washington, DC 20210

2.) If the answer to the question in 1.) is yes, then an interested party (those affected by the action) can request review and reconsideration from the Wage and Hour Administrator (See 29 CFR Part 1.8 and 29 CFR Part 7). Write to:

Wage and Hour Administrator
U.S. Department of Labor
200 Constitution Avenue, N.W.
Washington, DC 20210

The request should be accompanied by a full statement of the interested party's position and by any information (wage payment data, project description, area practice material, etc.) that the requestor considers relevant to the issue.

3.) If the decision of the Administrator is not favorable, an interested party may appeal directly to the Administrative Review Board (formerly the Wage Appeals Board). Write to:

JDPF
JDPF

Administrative Review Board
U.S. Department of Labor
200 Constitution Avenue, N.W.
Washington, DC 20210

WORR
WORR

4.) All decisions by the Administrative Review Board are final.

=====

END OF GENERAL DECISIO"



ATTACHMENT K NON-CONFLICT OF INTEREST CERTIFICATION

CARIBE TECNO, CRL

The CONTRACTOR certifies that:

1. No public servant of this executive agency has a pecuniary interest in this contract, subrecipient agreement, purchase, or commercial transaction.
2. No public servant of this executive agency has requested me or accepted from me, directly or indirectly, for him (her), for any member of his family unit or for any person, gifts, bonuses, favors, services, donations, loans or anything else of monetary value.
3. No public servant (s) requested or accepted any good of economic value, linked to this transaction, from any person of my entity as payment for performing the duties and responsibilities of their employment.
4. No public servant has requested from me, directly or indirectly, for him (her), for any member of his or her family unit, or for any other person, business, or entity, something of economic value, including gifts, loans, promises, favors or services in exchange for the performance of said public servant is influenced in my favor or of my entity.
5. I have no kinship relationship, within the fourth degree of consanguinity and second by affinity, with any public servant who has the power to influence and participate in the institutional decisions of this executive agency.

"I hereby certify under penalty of perjury that the foregoing is complete, true, and correct."

Signature

José D. Pérez Fernández

Printed Name

December 13, 2022

Date

Vice President of Caribe
Tecno, Inc., Administrator
of CARIBE TECNO, CRL

Position

JDPF
JDPF

WORR
WORR











Caribe Tecno Agreement Part I of 2

Final Audit Report

2022-12-19

Created:	2022-12-15
By:	Radames Comas Segarra (rcomas@vivienda.pr.gov)
Status:	Signed
Transaction ID:	CBJCHBCAABAAT4-hl8lmdfRLPgFOwB09m5zjNJPziUY

"Caribe Tecno Agreement Part I of 2" History

-  Document created by Radames Comas Segarra (rcomas@vivienda.pr.gov)
2022-12-15 - 9:00:20 PM GMT
-  Document emailed to jdpiii@caribetecno.com for signature
2022-12-15 - 9:03:29 PM GMT
-  Email sent to dramos@vivienda.pr.com bounced and could not be delivered
2022-12-15 - 9:03:52 PM GMT
-  Email viewed by jdpiii@caribetecno.com
2022-12-15 - 10:27:31 PM GMT
-  Signer jdpiii@caribetecno.com entered name at signing as José D. Pérez Fernández
2022-12-15 - 10:32:18 PM GMT
-  Document e-signed by José D. Pérez Fernández (jdpiii@caribetecno.com)
Signature Date: 2022-12-15 - 10:32:20 PM GMT - Time Source: server
-  Document emailed to w.rodriquez@vivienda.pr.gov for signature
2022-12-15 - 10:32:23 PM GMT
-  Email viewed by w.rodriquez@vivienda.pr.gov
2022-12-19 - 8:27:19 PM GMT
-  Signer w.rodriquez@vivienda.pr.gov entered name at signing as William O. Rodríguez Rodríguez
2022-12-19 - 8:31:42 PM GMT
-  Document e-signed by William O. Rodríguez Rodríguez (w.rodriquez@vivienda.pr.gov)
Signature Date: 2022-12-19 - 8:31:44 PM GMT - Time Source: server
-  Agreement completed.
2022-12-19 - 8:31:44 PM GMT











Caribe Tecno Agreement Part 2 of 2

Final Audit Report

2022-12-19

Created:	2022-12-15
By:	Radames Comas Segarra (rcomas@vivienda.pr.gov)
Status:	Signed
Transaction ID:	CBJCHBCAABAAAtCbR3DnsVLLLeGys2jbBgy-QeHy7722re

"Caribe Tecno Agreement Part 2 of 2" History

-  Document created by Radames Comas Segarra (rcomas@vivienda.pr.gov)
2022-12-15 - 9:06:04 PM GMT
-  Document emailed to jdpiii@caribetecno.com for signature
2022-12-15 - 9:10:06 PM GMT
-  Email sent to dramos@vivienda.pr.com bounced and could not be delivered
2022-12-15 - 9:10:12 PM GMT
-  Email viewed by jdpiii@caribetecno.com
2022-12-15 - 10:20:52 PM GMT
-  Signer jdpiii@caribetecno.com entered name at signing as José D. Pérez Fernández
2022-12-15 - 10:26:28 PM GMT
-  Document e-signed by José D. Pérez Fernández (jdpiii@caribetecno.com)
Signature Date: 2022-12-15 - 10:26:30 PM GMT - Time Source: server
-  Document emailed to w.rodriquez@vivienda.pr.gov for signature
2022-12-15 - 10:26:32 PM GMT
-  Email viewed by w.rodriquez@vivienda.pr.gov
2022-12-19 - 8:31:57 PM GMT
-  Signer w.rodriquez@vivienda.pr.gov entered name at signing as William O. Rodríguez Rodríguez
2022-12-19 - 8:35:22 PM GMT
-  Document e-signed by William O. Rodríguez Rodríguez (w.rodriquez@vivienda.pr.gov)
Signature Date: 2022-12-19 - 8:35:24 PM GMT - Time Source: server
-  Agreement completed.
2022-12-19 - 8:35:24 PM GMT