

**ENVIRONMENTAL ASSESSMENT
DETERMINATIONS AND COMPLIANCE FINDINGS
FOR HUD-ASSISTED PROJECTS
24 CFR PART 58**

FOR:



Centro de Distribución de Supermercados Econo Inc.
Canóvanas, PR.



U.S. Department of Housing and Urban
Development

451 Seventh Street, SW
Washington, DC 20410
www.hud.gov
espanol.hud.gov

Environmental Assessment Determinations and Compliance Findings for HUD-assisted Projects 24 CFR Part 58

Project Information

Project Name: Econo Energy Project / IPGM-00375

Responsible Entity: Puerto Rico Department of Housing (PRDOH)

Grant Recipient (if different than Responsible Entity): Supermercados Econo, Inc

State/Local Identifier: Puerto Rico / Canóvanas

Preparer: Héctor L Sánchez-Cruz, PE – SCA Consulting Engineering LLC

Certifying Officer Name and Title:

Juan Carlos Perez-Bofill - Director, Disaster Recovery CDBG-DR

Sally Z. Acevedo-Cosme - Permits and Environmental Compliance Specialist

Pedro de León Rodriguez - Permits and Environmental Compliance Specialist

Maria T. Torres-Bregón - Permits and Environmental Compliance Manager

Angel G. López Guzmán - Deputy Director, Permits and Environmental Compliance Specialist

Ivelisse Lorenzo Torres - Permits and Environmental Compliance Specialist

Santa Ramírez Lebrón - Permits and Environmental Compliance Specialist

Janette I. Cambrelen - Permits and Environmental Compliance Specialist

Limary Vélez Marrero - Permits and Environmental Compliance Specialist

Mónica Machuca Rios - Permits and Environmental Compliance Specialist

Aldo A. Rivera Vazquez - Director of Program Management

Priscilla Toro Rivera - Permits and Environmental Compliance Specialist

Abdul Feliciano Plaza - Permits and Environmental Compliance Specialist

Javier Mercado Barrera - Permits and Environmental Compliance Specialist

Consultant (if applicable): SCA Consulting Engineering LLC.

Direct Comments to: Puerto Rico Department of Housing- environmentcdbg@vivienda.pr.gov

Project Location:

Road PR-3, Km. 16.2, Lot 3, Canovanillas Ward, Canóvanas, Puerto Rico

Site Coordinates: 18.373613°, -65.906549°

Cadaster number: 117-000-003-01-000

See **Appendix 1** for map with Site Location.

Description of the Proposed Project [24 CFR 50.12 & 58.32; 40 CFR 1508.25]:

The proposed project consists of the construction of a new Hybrid Power Plant for the Econo supermarket chain's distribution center in Canóvanas, Puerto Rico. A hybrid energy system combines one or more renewable with non-renewable energy sources, which may be connected to the electric grid, or operate off the grid in some instances. For the Econo Distribution Center, the proposed power configuration includes approximately 2,750 photovoltaic panels to generate clean, solar energy, combined with a generator powered by natural gas, and a Battery Energy Storage System (BESS) to store energy generated from both sources.

The project also includes a new thermal recovery system to reduce water consumption and wastewater discharges from the facility. The heat generated by the engine will be delivered to a new evaporator to treat the wastewater from the utilities. This process will generate distilled water, that will be directed to a cooling tower, and mineral concentrated salt waste (sludge) that will be directed to a drying bed. In the drying bed, the sludge will de-water and the remaining material can be disposed in a landfill or may also be reused as fertilizer or animal feed. Thus, the new utilities for the thermal recovery system include an evaporator, a cooling tower, water storage tanks, drying beds and all the ancillary equipment required for their operation, such as pumps, piping and electrical connections. See figure 1 for details of the proposed project flow diagram.

The activity will involve excavations on the industrial site to construct foundations and installation of underground utilities. Underground water pipes from the existing cooling towers will be connected to the evaporator system and from the evaporator to the towers for recycling water. The ground impact at the site will be required for the gas engine (48.31 m²), the new battery system (45.52 m²), the dry cooler (15.79 m²), CW pumps (0.84 m²), HT pumps (0.84 m²), electrical container (45.52 m²), buffer tank (1.86 m²), evaporator (5.57 m²), blowdown buffer tank (29.73 m²), conditioned water buffer tank (14.86 m²), three drying beds (148.64 m²), and LNG regasification plant (195.10 m²), for a total area of 552.59 m². The estimated depth of bases for each of these areas is estimated at 0.3 meters (1 ft). Pipes connecting each of the project elements, including water pipes, electrical conduits, and any other underground lines, will also be installed at the depth of 0.3 meters (1 ft).

As mentioned, the proposed project will occur at a warehouse and distribution center operated and owned by the Econo company since it was constructed between 2019 and 2021. Thus, no site expansion or land acquisition will be required.

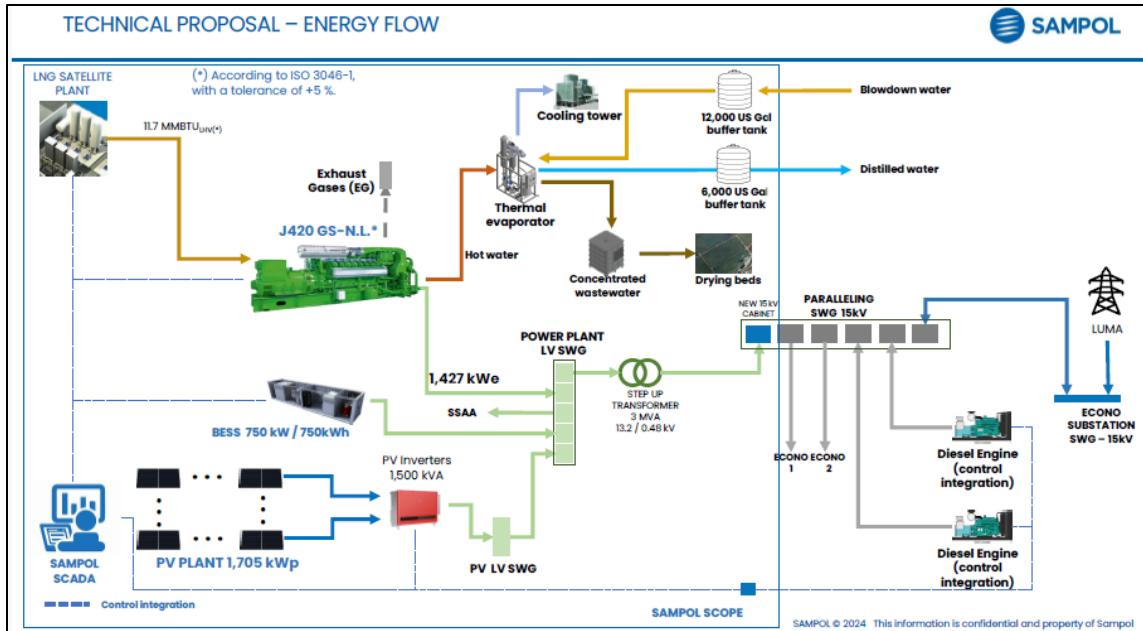

Figure 1 - Proposed material flow

The following is a list of the new equipment that the proposed project includes:

Photovoltaic Plant (PV)

- Estimated 2,750 solar panels will be installed on the roof of the warehouse.
- Electrical conduits and general installation of electrical conduits and wires to Low Voltage switchgear plant located within the facility.

Generator

- 1x Natural Gas Genset-Container (engine type Jenbacher J420 GS-N.L). The unit will use Natural Gas as its main fuel source and is prepared for conversion to operate with hydrogen.
- Electrical power on site 1,427 kW_e
- Voltage generation: 480V, 60Hz

Liquefied Natural Gas (LNG) plant

- 20,000-gallon storage tank (5 days autonomy - 1.3 MWe average demand)
- Vaporizers
- Pump skid

Battery Energy Storage System (BESS)

- Low Voltage BESS 750 kWh/ 750 Kw

Electrical system

- Control equipment to be in a trailer type structure
- Low Voltage Plant SWG cabinets: Solar Panel System, Genset, BESS, Auxiliary loads and output to Step-up transformer

- Step-Up Transformer 3,000kVA, 0.48/13.2kV installed in the Power Plant area
- 1 x HV cabinet to be installed in the existing Paralleling Switchgear – 15kV

Control System

- Distributed Control System and monitoring of grid interconnection.
- Remote operation, SCADA and visualization.
- Operation desk to be located at control room.
- BESS integration.
- Existing Diesel power plant integration.

Utilities -thermal recovery

- Cooling tower
- Blowdown and Distilled water tank
- Concentrated wastewater storage and drying beds will be installed to handle the wastewater from the evaporator and generate a sludge that will be landfill-disposed.
- Piping associated with all the new material flow

Civil engineering elements include:

- Genset, BESS, and LV electrical container foundations
- HV Cabinet to be installed inside Engine room at existing foundation.
- Electrical canalization (considering using existing ones).
- The removal of gravel from the Natural Gas Engine and LNG areas is contemplated for its subsequent reuse.
- Stormwater & Control of Erosion and Sedimentation during construction
- Retaining wall, access ladder, and cementation included in the LNG area.
- Gas piping canalization to Natural Gas Engine
- Safety Fence
- Underground geo survey to be performed to determine any interferences with new pipping and trenches.
- Latest available Geotechnical study to be provided to designer company by Econo.

The Project’s Technical Proposal, included in **Appendix 2**, provides information and details on the project’s elements.

Statement of Purpose and Need for the Proposal [40 CFR 1508.9(b)]:

The Puerto Rico Department of Housing (PRDOH) launched the Economic Development Investment Portfolio for Growth – Lifeline Mitigation Program (IPG-MIT), with the objective to target economic development funding for privately owned lifeline infrastructure to support Risk-Based Mitigation Needs. The IPG-MIT program intends to support private investment in lifeline infrastructure to increase stability and/or expansion of lifeline services.

The site’s electrical needs are supplied by LUMA Energy, the power company responsible for power distribution and power transmission in Puerto Rico. However, the energy supply is

unstable, and this poses a risk for food that requires a controlled temperature. Currently, the facility has emergency power generation from two (2) diesel-powered engines, each with a nominal capacity of 2,500 kWe, but these cannot be used for prolonged periods of time.

The proposed activity will add power generation capacity by means of a combined photovoltaic system, a power generator that runs on natural gas, and BESS in addition to the existing emergency-power generator units that will remain at the site and will continue to be used as needed. The proposed new energy supply will be an additional source of electricity during emergency and non-emergency periods. This new power source will ensure operation continuity year-round, reducing threats to food security and distribution on the island. Econo is one of the largest food suppliers on the island, and the site serves as the main distribution center for the supermarket chain. This project's objective is to provide electrical autonomy to the facility in case of catastrophic events affecting the island-wide power supply and distribution. The Hybrid Power Plant will supply power solely to the cold storage facility, not serving any offsite structures or other facilities on site.

Existing Conditions and Trends [24 CFR 58.40(a)]:

As indicated previously, the proposed project will be developed at an existing and operational industrial site that serves as a warehouse and distribution center for Econo Supermarkets. The site was constructed between 2019 and 2021 and has since been in operation by Econo. The proposed project will only impact areas within the facility's boundaries, so no expansion or land acquisition will be needed. Since the site is developed, there are no areas that can serve as habitat for threatened or endangered species. When the facility was developed, wetland areas were delineated and mitigated to the East of the site. There is a detention pond to the East, beyond the site boundary fence. Wetland areas are over 100 feet from the project area (see wetland section below and Appendix 15). The site has no unique qualities in terms of environmental resources, architectural styles or historical context that could be impacted by the proposed activity. The location is a fully developed industrial site that has been deprived of natural attributes.

The site includes two main buildings and three parking lots, located to the North, West and South of the buildings. There are other smaller buildings to support utilities and operations. The topography for the site has been manipulated to make it flat. The *Supermercados Econo Distribution Center* is a modern construction located in a terrain previously used until as a quarry, until c.2006, and which was impacted by heavy machinery to produce boulders and gravel for the construction industry.

As mentioned, the project site is supplied by an unstable energy supply and will continue to maintain a deficient and inconsistent source of energy in the absence of this project. This puts the food products at the site as risk of spoiling and inhibits the facilities ability to have consistent food distribution services. This trend is foreseen to continue in the absence of the project.

Funding Information

Grant Number	HUD Program	Funding Amount
B-18-DP-72-0002	Community Development Block Grant – Disaster Recovery (CDBG-MIT)	\$8,285,284,000

Estimated Total HUD Funded Amount: \$8,222,500.00

Estimated Total Project Cost (HUD and non-HUD funds) [24 CFR 58.32(d)]: \$19,149,819.00

Funding Sources	Amount
CDBG-MIT	\$8,222,500.00
Other Federal (USDA-REAP)	\$1,000,000.00
Applicant Contribution	\$9,927,319.00

Compliance with 24 CFR 50.4, 58.5, and 58.6 Laws and Authorities

Record below the compliance or conformance determinations for each statute, executive order, or regulation. Provide credible, traceable, and supportive source documentation for each authority. Where applicable, complete the necessary reviews or consultations and obtain or note applicable permits of approvals. Clearly note citations, dates/names/titles of contacts, and page references. Attach additional documentation as appropriate.

Compliance Factors: Statutes, Executive Orders, and Regulations listed at 24 CFR §58.5 and §58.6	Are formal compliance steps or mitigation required?	Compliance Determinations
STATUTES, EXECUTIVE ORDERS, AND REGULATIONS LISTED AT 24 CFR 50.4 and 58.6		
Airport Hazards 24 CFR Part 51 Subpart D	Yes No <input type="checkbox"/> <input checked="" type="checkbox"/>	<p>The closest airport to the project site is the San Juan Luis Muñoz Marin international Airport (SJU), located approx. 36,800 feet (about 11.22 km) to the Northwest of the project site. The SJU is a joint-use airport that serves military and civil needs. Per HUD, the Accident Potential Zone (APZ) is within a radius of 15,000 feet from a military airport runway.</p> <p>The nearest civilian airport is the Fernando Luis Ribas (SIG), located approx. 72,539 feet (about 22.11 km) to the Northwest of the project site. HUD has established that the Runway Protection Zone/Clear Zone (RPZ/CZ) is within 2,500 feet of the nearest civil airport.</p> <p>Since the project is located at a greater distance than both the APZ and the RPZ/CZ, the site</p>

		project is in compliance with Airport Hazards requirement and no compliance measures are needed. Refer to Appendix 3 for a map of airport locations.
<p>Coastal Barrier Resources</p> <p>Coastal Barrier Resources Act, as amended by the Coastal Barrier Improvement Act of 1990 [16 USC 3501]</p>	<p>Yes No</p> <p><input type="checkbox"/> <input checked="" type="checkbox"/></p>	<p>According to information obtained from the U.S. Fish and Wildlife (USFWS) Coastal Barrier Resources System Mapper, the site is located outside of the Coastal Barrier Resource System (CBRS). The closest resource (Punta Vacia Talega PR-87) is over 2.22 miles to the North of the project site. Therefore, the project has no potential to impact a CBRS Unit and complies with the Coastal Barrier Resources Act. Refer to Appendix 4 for map of CBRS.</p>
<p>Flood Insurance</p> <p>Flood Disaster Protection Act of 1973 and National Flood Insurance Reform Act of 1994 [42 USC 4001-4128 and 42 USC 5154a]</p>	<p>Yes No</p> <p><input type="checkbox"/> <input checked="" type="checkbox"/></p>	<p>According to the FEMA Flood Insurance Rate Maps (FIRM), the proposed project site is not located in a 100-year floodplain. The project site is located in Zone X as per panels number 72000C0395J and 72000C0760J, both with effective date of 11/18/2009. Therefore, the project is in compliance with flood insurance. Refer to Appendix 5 for the FIRM map.</p>

STATUTES, EXECUTIVE ORDERS, AND REGULATIONS LISTED AT 24 CFR 50.4 & 58.5		
<p>Clean Air</p> <p>Clean Air Act, as amended, particularly section 176(c) & (d); 40 CFR Parts 6, 51, 93</p>	<p>Yes No</p> <p><input type="checkbox"/> <input checked="" type="checkbox"/></p>	<p>The proposed project does not include new construction or conversion of land use, but it does involve the construction of new air emission sources in an existing industrial facility. No population density increase is expected from project activities.</p> <p>Currently, according to the EPA Green Book "Puerto Rico Nonattainment / Maintenance Status for Each County by Year for all Criteria Pollutants," the proposed project is located within an Attainment of the municipality of Canóvanas, PR.</p> <p>The project will establish a new emission source that will use LNG for fuel. Emissions estimates considered the use of the new generator continuously for an entire year (365 days) simultaneously to use of emergency power equipment for a period of 500 hours per year. This is an unrealistic scenario but one that provides a worst-case emission estimates. When compared to rates in non-attainment areas, per</p>

		<p>40 CFR 93.153(b)(2), the emissions will not alter the current attainment area status. The new air emission source will be equipped with controls to ensure the best performance.</p> <p>The emissions associated with the construction period, such as dust, can be mitigated with best management practices and controls.</p> <p>Due to the scale of activities, the air emissions can be assumed to be below de minimis levels, and the project does not constitute a major source of air pollution (to be determined). AS such, the project complies with the Clean Air Act.</p> <p>Per local regulations, the Department of Natural and Environmental Resources (DNER) will require an air emission source permit for the new facility. This will be managed according to the regulations of the agency. Refer to Appendix 6 for Attainment area Map, EPA Green Book data, engine specs and emission calculations.</p>
<p>Coastal Zone Management Coastal Zone Management Act, sections 307(c) & (d)</p>	<p>Yes <input type="checkbox"/> No <input checked="" type="checkbox"/></p>	<p>The proposed project is not within the Puerto Rico coastal zone delineation. The site is about 1 mile south from the delineated coastal zone area, based on Puerto Rico Planning Board map. Thus, the project complies with the Coastal Zone Management Act. Refer to Appendix 7.</p>
<p>Contamination and Toxic Substances 24 CFR Part 50.3(i) & 58.5(i)(2)</p>	<p>Yes <input type="checkbox"/> No <input checked="" type="checkbox"/></p>	<p>Based on the historical Imagery from Google Earth, the site was not developed in 2018 and was previously used as a quarry. The 2019 image shows soil movement for the facility's construction and in 2021 the site was developed. This shows the site was undeveloped before 2019.</p> <p>Based on NEPAassist, Envirofacts, and EPA Echo information, there are several EPA facilities within a 3,000-foot buffer of the projects' site, including 8 Hazardous Waste (RCRAInfo) generators, 3 Brownfields (ACRES), 2 sites that issue Toxic Release inventory (TRI), 1 Air Pollution (ICIS-AIR) emitter, 2 Water Dischargers (NPDES) (including the project site) and 1 Superfund (NPL). Regarding the NPL site, upon detailed review of the Environmental Protection Agency, there are no sites within the municipality of Canovanas. The other sites reflect past or present industrial activities that</p>

	<p>require some reporting or registration with the EPA and are not expected to affect the development and use of the proposed project.</p> <p>A site visit conducted on June 17, 2024, did not reveal concerns at the site with the handling of toxic substances or petroleum. The activities at the site appear to be following the EPA requirements, per ECHO report (see Appendix 8), there are no enforcement actions or non-compliance records.</p> <p>The location of sites with environmental activities listed by the EPA within a 3,000 of the proposed project will not result in conflicts with the intended use of the property or the proposed construction activities. Also, none of these sites are directly adjacent to the project.</p> <p>According to CPD-23-102 notice issued by HUD on January 11, 2024, Radon must be considered for structures that involve occupancy of at least 4 hours a day. The facility where the proposed project will be developed includes an existing building that will not be subject to evaluation of this ERR. The proposed project does include an elevated control room, whose daily occupancy has not yet been determined. The control room will be located on the second floor within a steel encased container that will be placed aboveground over a concrete pad and anchored. This further limit potential radon or intrusion into the work area. However, PRDOH has determined that Radon testing and mitigation at this moment is impracticable and not feasible, as explained in the memorandum included in Appendix 8.</p> <p>The facility, built between 2019 and 2021, is unlikely to contain lead-based paint (LBP) as it was banned in 1978. The project designer confirmed that for installation of lines that cross the road and enter the building, there are existing underground conduits underground that will be used. Therefore, no roads or sidewalks of the facility will require removal or cutting. New conduits that will be installed will occur in gravel or areas that are currently not paved or asphalted, thus soil removal will be necessary. As such, no roadway asphalt removal</p>
--	--

		<p>for trenching will be required and no road paint will be removed during the construction activities. Therefore, an LBP assessment for road paint will not be required.</p> <p>Asbestos-containing materials (ACMs) are generally no longer used in roof construction or waterproofing today due to the significant health risks associated with asbestos exposure. Asbestos was commonly used in roofing materials, insulation, and waterproofing products in the past due to its fire-resistant and durable properties. However, it has been heavily regulated due to its link to serious health conditions, such as lung cancer, asbestosis, and mesothelioma. Today, modern roofing materials, such as bituminous membranes, synthetic rubber, PVC, and other waterproofing systems, are used instead of asbestos-containing products. Due to the recent construction of the building, there is no concern of ACM within the site.</p> <p>Rehabilitation of buildings containing ACM is regulated by the EPA under the National Emission Standards for Hazardous Air Pollutants (NESHAP), standard for demolition and renovation (40 CFR 61.145), the EPA standard for waste disposal for manufacturing, fabricating, demolition, and spraying operations, (40 CFR 61.150) and Puerto Rico "Regulation for the Control of Atmospheric Pollution" and no paint will be disturbed on the parking lot, therefore, there are no activities or circumstances that point to the presence of LBP or ACM at the site, and no mitigation activities will be required.</p> <p>Given that the site is an industrial property, and the facility was recently constructed, the following regulations and laws do not apply to the project: HUD's Lead-Safe Housing Rule (LSHR), EPA's Lead Renovation, Repair, and Painting (RRP) Rule, and the Puerto Rico Department of Natural and Environmental Resources (DNER) <i>Reglamento para el manejo adecuado de actividades de pintura con base de plomo</i> (Reglamento #9098 del 16 de julio de</p>
--	--	---

		<p>2019) as these apply to housing where there is exposure to vulnerable populations.</p> <p>The new generator will have an oil reservoir of about 80 gallons, requiring an update to the site’s Spill Prevention, Control, and Countermeasure (SPCC) plan in accordance with 40 CFR Part 112 to include this new unit.</p> <p>As per the information assessed, the proposed project complies with the Contamination and Toxic Substances requirement. Refer to Appendix 8 for historical imagery and facilities’ NEPAAssist reports.</p>
<p>Endangered Species Endangered Species Act of 1973, particularly section 7; 50 CFR Part 402</p>	<p>Yes <input checked="" type="checkbox"/> No <input type="checkbox"/></p>	<p>A Not Likely to Adversely Affect (NLAA) determination was issued for Section 7 ESA compliance. The memorandum explains that the project area is devoid of natural features and operates as an industrial site, lacking suitable habitat for listed species. Also, there are no Critical Habitats (see Critical Habitat map included in Appendix 9) at or near the project site. The nearest Critical Habitat is at “El Yunque National Forest” over 6.63 miles (35,006 ft) southeast of the proposed project location.</p> <p>According to by the US Fish and Wildlife Service’s (USFWS) Information for Planning and Consulting (IPaC) tool and presented in the information included in Appendix 9, indicates that the Puerto Rican Boa may be found in the project area. Due to widespread distribution of the Puerto Rican Boa, PRDOH has established guidelines to be followed in case an individual of the specie is found at the project site.</p> <p>If a Puerto Rican Boa is found in the project action site, work shall cease until the Boa moves off on its own. If the Boa does not move off, the contractor shall contact the Puerto Rico Department of Natural and Environmental Resources and ask for them to relocate the boa.</p> <p>On Dec 11, 2024, the USFWS concurred with the NLAA determination for threatened or endangered species. This determination required that Conservation Measures be implemented during the construction process. These are listed and included in Appendix 9 of this document and include dissemination of</p>

		<p>information of the species, construction site boundary delimitation, inspection of work area by experienced personnel, specific instructions on what to do if there is a boa sighting or identification within the construction area, and others. The contractor will develop the plan for the site and execute the Conservation Measures.</p> <p>Upon implementation of the Conservation Measures, the project complies with the Endangered Species Act. Refer to: Appendix 9.</p>
<p>Explosive and Flammable Hazards 24 CFR Part 51 Subpart C</p>	<p>Yes <input type="checkbox"/> No <input checked="" type="checkbox"/></p>	<p>The proposed project does not involve the construction, development or rehabilitation of a facility to increase residential density. Also, the project or the site is not considered as a facility solely for the storage, handling and processing of flammable or combustible chemicals. However, the proposed action will involve the installation of flammable hazards at the site in the form of a pressurized natural gas tank. To identify if nearby buildings and residential areas are within a safe distance, the Acceptable Separation Distance (ASD) Assessment tool was used. (https://www.hudexchange.info/programs/environmental-review/asd-calculator/) The ASD tool result for Thermal Radiation for People (ASDPNPD) is 181.84 feet. The ASD tool result for Thermal Radiation for Buildings (ASDBNPD) is 31.75 feet. The LNG facility will be 180 feet from the nearest building within the industrial facility. The building is made of concrete and people will be working within the building, normally shielded from the LNG facility. According to the assessment tool, the distance is acceptable. The LNG will be located 139 feet from an above ground, 15,000 gal, diesel fuel tank. The LNG facility will be located at over 1,000 feet from areas outside the facility where people congregate, live and work or have outside activities. This includes a distance of 1,144 ft from a shopping center to the East of the facility, 1,101 feet from horse stables, 1,439 ft from residential areas to the West of the facility and 1,877 ft from residential areas to the East of the facility.</p>

		<p>The LNG tank proposed is 20,000 gallons in volume, and intended to be used in an industrial setting, it is not exempt from meeting codes and standards from NPFA 59A Ed. 2019. The LNG facility will comply with these standards.</p> <p>The facility where the project will be developed handles flammable and/or combustible chemicals such as bulk fuel storage. There is a 15,000-gal, aboveground fuel tank adjacent to the building that houses the emergency-power generators. Inside this building there are two 600-gal day tanks, one for each generator. In addition, there are two mobile 600-gal storage tanks to supply mobile EGUs, a 4,500 gal diesel fuel tank truck, and an 15,850 gal fuel tank trailer. The facility has in place spill preventive measures for these units such as double-wall, containment areas and other measures as described on the sites Spill Prevention, Control and Countermeasures (SPCC) plan. The facility has in place administrative and engineered measures in place to monitor these units and provide quick emergency response should a fire or spill occur.</p> <p>Per design, the Acceptable Separation Distance required by HUD is met, the project complies with the requirements for Explosive and Flammable Hazards. See Appendix 10 for layout drawings, ASD calculation result, specs and tank descriptions.</p>
<p>Farmlands Protection Farmland Protection Policy Act of 1981, particularly sections 1504(b) and 1541; 7 CFR Part 658</p>	<p>Yes <input type="checkbox"/> No <input checked="" type="checkbox"/></p>	<p>According to the information issued by the Natural Resources Conservation Service (NRCS) from the US Department of Agriculture (USDA), the project site is in areas identified as “Not prime farmland”, “Prime farmland if drained”, and “Prime farmland if protected from flooding or not frequently flooded during growing season.” Soil types are MaC2, CbF, MaD2, MaB, and GPQ. However, the entire project site has already been developed for industrial use and the proposed project will not require any activities including new construction in undeveloped land, acquisition of undeveloped land or conversion of land that could convert agricultural land to non-agricultural land use. According to HUD exchange, the Act does not apply to projects already in or committed to urban development or those that could</p>

		<p>otherwise not convert farmland to non-agricultural uses. Furthermore, the Census TIGER maps and the Puerto Rico Planning Board's <i>Plan de Uso de Terreno</i> (PUT) map show the project site is designated as urban area. As such, the project is in compliance with the Farmland Protection Policy Act. See Appendix 11. https://websoilsurvey.nrcs.usda.gov/app/</p>
<p>Floodplain Management Executive Order 11988, particularly section 2(a); 24 CFR Part 55 EO 13690 and 11988 According to the New Rule (FFRMS)</p>	<p>Yes <input type="checkbox"/> No <input checked="" type="checkbox"/></p>	<p>The project is partially located within an FFRMS floodplain, as indicated by the ABFE and PFIRM maps, but it is not classified as a critical action. This determination was made using the Free Value Approach (FVA). According to the FFRMS tool, a 2-foot freeboard is applicable, corresponding to a FFRMS flood elevation of 35.1 feet (see appendix 12). The USGS Elevation Point Query Service reports the site's elevation as approximately 51.37 feet (15.66 meters). The Effective FIRM maps (Appendix 5) show that the project is not within the 100- or 500-year floodplain, but is located in Zone X, as per panels 72000C0395J and 72000C0760J, both with an effective date of 11/18/2009. While portions of the project site are within a floodplain, as indicated by the ABFE (Appendix 12a) and PFIRM (Appendix 12b), the site's elevation of 51.37 ft exceeds the area's Base Flood Elevation of 35.1 ft due to the construction development levels. The project is exempt from completing the full 8-dstep decision-making process as it meets the exemption under 24 CFR § 55.13 (e), which pertains to energy efficiency projects that do not meet the threshold for substantial improvement. Based on the calculation provided in Appendix 12, the estimated substantial improvement for this project is 23.38%, which is below the threshold for substantial improvement. Therefore, the project is in compliance with Executive Order 11988, as amended by Executive Order 13690.</p>
<p>Historic Preservation National Historic Preservation Act of 1966, particularly sections 106 and 110; 36 CFR Part 800</p>	<p>Yes <input type="checkbox"/> No <input checked="" type="checkbox"/></p>	<p>The following historic properties have been identified within the APE and the Program has determined the project will have the following effects on them:</p>

		<p>•Direct Effect: There are no NRHP-listed/eligible historic properties within the direct APE of the proposed High-Efficiency Hybrid Power Plant for the Supermercados Econo Distribution Center in Canóvanas, Puerto Rico. The area was originally a modern quarry, operating with drastic impact to the terrain from the 1960s 2006. The proposed undertaking has an estimated depth of impact of one foot. The original hill terrain was reduced by over 137.79 ft, as revealed by the destruction of a 1930s aljibe or cistern, documented in historic aerial photographs and topographic maps. The potential for unearthing intact material deposits is considered zero.</p> <p>•Indirect Effect: There are no listed NRHP-listed/eligible historic properties within the viewshed or visual APE at ground level, nor within a quarter-mile radius. The Casa Jesús T. Piñero; TCN-EH5 (CW0200010), is located 0.31 miles northwest, and the Canóvanas Traditional Urban Center is located 0.35 miles northeast. Given the distance to both historic properties, and the minimal scale of the proposed High-Efficiency Hybrid Power Plant for the Supermercados Econo Distribution Center, no indirect effects are anticipated.</p> <p>The project activities were submitted to PRSHPO on 10/18/2024. The agency concurred with the finding of "no adverse effects to historic properties" on 10/18/2024. No further mitigation is needed. As a result, the project adheres to the National Historic Preservation Act. See Appendix 13.</p>
<p>Noise Abatement and Control Noise Control Act of 1972, as amended by the Quiet Communities Act of 1978; 24 CFR Part 51 Subpart B</p>	<p>Yes No <input type="checkbox"/> <input checked="" type="checkbox"/></p>	<p>The project does not involve the construction or rehabilitation of a residential space; thus it is not considered to be a noise sensitive project, and therefore, a noise assessment was not required. The equipment installed will operate at levels acceptable to industrial receptors. The nearest site is located some 1,030 feet to the East of the property. This distance will help to mitigate sound effects.</p> <p>Noise may be generated by construction activities, but construction noise is not anticipated to impact the surrounding</p>

		neighborhood. The project is in compliance with HUD's Noise regulation.
<p>Sole Source Aquifers Safe Drinking Water Act of 1974, as amended, particularly section 1424(e); 40 CFR Part 149</p>	<p>Yes No <input type="checkbox"/> <input checked="" type="checkbox"/></p>	<p>There are no Sole Source Aquifers in Puerto Rico. Furthermore, the project consists of activities that are unlikely to have adverse impact on groundwater resources. The nearest SSA is approximately 1,100 miles (5,533,902 ft) from the project site. The project is in compliance with SSA requirements. Refer to Appendix 14.</p>
<p>Wetlands Protection Executive Order 11990, particularly sections 2 and 5</p>	<p>Yes No <input type="checkbox"/> <input checked="" type="checkbox"/></p>	<p>The proposed project will be developed within the confinement of an industrial/commercial facility. The project area does not have any wetlands on it, based on photos of the existing conditions of the project. This aligns with §55.9, <i>Identifying wetlands</i>, where it is indicated that identification of wetlands be performed by a visual assessment. Based on the National Wetlands Inventory map (see Appendix 15), the site is in proximity to offsite wetlands, which are identified to be located beyond the retention pond located directly to the East of the site. As presented, the proposed project will NOT have a direct impact on onsite wetlands because the construction area does not have any wetlands. This is true even if, for the purpose of this evaluation, we consider that the retention pond as a wetland, yet no grading, clearing, draining, filling, diking, impounding, or related activity will take place there, thus no direct impact will occur in the pond. This clause does not trigger the 8-step process.</p> <p>The proposed project will not affect the flow of storm water, release pollutants or otherwise change conditions that contribute to wetland viability. The activity will not affect the current patterns of storm water of the site, which will continue to release to the pond. The construction/installation of the proposed elements will not release pollutants to the environment which may alter the wetland composition. In any case, it can be argued that the ground disturbance at the site may impact the stormwater due to the possibility of erosion or sedimentation movement during construction only. However, this impact will be minimized through best management practices. As described in this section, this is not a reason</p>

		<p>for having to perform the 8-step process. The characteristics of the project help to further minimize the impact to off-site wetlands, given that a retention pond acts as a buffer to reduce impact to offsite wetlands. Thus, there is an added protection to offsite wetlands from the pond itself and the risk of impact to offsite wetlands is further reduced.</p> <p>Thus, for this project there will be no direct impact on onsite wetlands because there are none. Also, indirect impact to offsite wetland may be addressed with best management practices, as stated by the regulation. Therefore, with respect to impacts to wetlands, no decision-making process needs to be addressed. This complies with §55.10 and, as such, the proposed project is in compliance with Executive Order 11990. Refer to information in Appendix 12A and map in Appendix 15.</p>
<p>Wild and Scenic Rivers Wild and Scenic Rivers Act of 1968, particularly section 7(b) and (c)</p>	<p>Yes No <input type="checkbox"/> <input checked="" type="checkbox"/></p>	<p>Puerto Rico has three Wild and Scenic Rivers which are located in the east side of Puerto Rico. The closest wild and scenic river is over 9 miles to the east of the proposed project site; thus, the project is in compliance with Wild and Scenic Rivers Act. Refer to Appendix 16.</p>
ENVIRONMENTAL JUSTICE		
<p>Environmental Justice Executive Order 12898</p>	<p>Yes No <input type="checkbox"/> <input checked="" type="checkbox"/></p>	<p>The proposed project will be developed within an already established industrial site, and there is significant distance to community areas. Within a one-mile radius, the socioeconomic indicators in the community include 54% low income, 12% unemployment rate, compared to the island average of 70% and 14% respectfully. The development of the project will benefit low- and moderate-income communities not just in the project area but in areas far from it by providing food supply security. Thus, there will be no disproportionate impact on these communities. No adverse environmental impacts were identified in the project's total environmental review. Therefore, the proposed activity complies with Executive Order 12898. See Appendix 17 for EJ data.</p>

Environmental Assessment Factors [24 CFR 58.40; Ref. 40 CFR 1508.8 &1508.27] Recorded below is the qualitative and quantitative significance of the effects of the proposal on the character, features and resources of the project area. Each factor has been evaluated and documented, as appropriate and in proportion to its relevance to the proposed action. Verifiable source documentation has been provided

and described in support of each determination, as appropriate. Credible, traceable and supportive source documentation for each authority has been provided. Where applicable, the necessary reviews or consultations have been completed and applicable permits of approvals have been obtained or noted. Citations, dates/names/titles of contacts, and page references are clear. Additional documentation is attached, as appropriate. **All conditions, attenuation or mitigation measures have been clearly identified.**

Impact Codes: Use an impact code from the following list to make the determination of impact for each factor.

- (1) Minor beneficial impact
- (2) No impact anticipated
- (3) Minor Adverse Impact – May require mitigation
- (4) Significant or potentially significant impact requiring avoidance or modification which may require an Environmental Impact Statement

Table 1. Environmental Assessment Factors (Land Development).

Environmental Assessment Factor	Impact Code	Impact Evaluation
LAND DEVELOPMENT		
Conformance with Plans / Compatible Land Use and Zoning / Scale and Urban Design	2	According to Puerto Rico Planning Board data, the facility has a classification for Industrial use, and a designation of Urban Soil (see Appendix 18). The proposed activity is compatible with the site’s current land use classification and use. There will be no changes to land use or zoning.
Soil Suitability/ Slope/ Erosion/ Drainage/ Storm Water Runoff	2	<p>The proposed activity will not require significant changes to the site’s topography, nor will it require significant soil movement. The area where the project will be located has been previously leveled and filled during the construction of the site. The areas where equipment installation and construction will occur will be stabilized to avoid soil erosion.</p> <p>The proposed project will not affect the flow of storm water, release pollutants or otherwise change conditions that contribute to wetland viability. The activity will not affect the current patterns of storm water of the site, which will continue to release to the retention pond located to the East, outside the permitter fence. To avoid impact to the retention pond due to possibility of erosion or sedimentation movement during construction, best management practices will be implemented via the development and implementation of a Erosion and Sedimentation control plan.</p>
Hazards and Nuisances including Site Safety and Noise	2	<p>Hazards</p> <p>Based on findings presented above in Contamination and Toxic Substances, the project site has above ground storage of explosive or flammable materials. During construction, OSHA</p>

	<p>regulations will be followed to address any construction operational hazards. The proposed project involves the installation of a facility that manages a flammable and explosive substandard. However, the project is compliant with the appropriate separation distance (ASD) established by HUD. Administrative and engineering controls will be in place during the operation of the equipment at the site to ensure the hazards are minimized to controlled levels and avoid employee exposure.</p> <p>The most common hazards in the area include fires, earthquakes, and hurricanes. The facility has emergency brigades, fire control and communication systems in place to minimize the spread of any hazard.</p> <p>Noise</p> <p>Construction noise would be temporary and mitigated as per Regulations for Noise Pollution Control of the Department of Natural and Environmental Resources (DNER - formerly the Environmental Quality Board). Noise will be incidental to the construction period and the activities being performed during this phase. Contractors will be required to follow OSHA regulations to mitigate employee noise exposure, which may include the use of ear protection.</p> <p>Noise during the operation will be controlled by engineering and administrative controls aimed at minimization of exposure to employees and nuisance noise to area receptors. However, the nearest receptor is a commercial property located approximately 1,030 feet to the east of the site. The distance aids in noise dissipation and thus, it is not expected that the noise impacts commercial or residential areas.</p> <p>Nuisance</p> <p>The construction activity will introduce nuisances to the work area that include traffic limitation, dust and noise. These are expected to directly affect surrounding areas within the facility. Construction areas will be isolated, and several measures will be taken to reduce the impact of these nuisances, which include adequate maintenance of vehicle access and traffic within the site, fugitive dust control and noise control. Construction activities at night may be necessary to reduce conflicts with the site's operations, increase worker safety, and advance the construction process. All activities will be coordinated internally, as no external users will be affected by the activities. The nuisance will be incidental to the construction phase and will vary in intensity depending on the activities being performed. Once in operation, any nuisance associated with the construction will be eliminated.</p>
--	--

Table 2. Environmental Assessment Factors (Socioeconomic).

Environmental Assessment Factor	Impact Code	Impact Evaluation
SOCIOECONOMIC		
Employment and Income Patterns	1	The proposed activity will involve temporary construction employment. It is expected that 8 to 10 jobs may be created during construction. Once completed the operation of the new equipment will have continuous supervision during its operation. The new project is expected to add 1-4 permanent jobs at the existing site.
Demographic Character Changes, Displacement	2	The project will not require relocation or displacement of any population group or individuals. Therefore, there are no associated demographic changes to the proposed project.
Environmental Justice	2	The proposed project will not disproportionately affect low-income communities. Areas around the facility are at a safe distance from the proposed facilities and will not be affected by air emissions, noise or dust. The appropriate separation distance from the facility to areas where people congregate, and residential areas will be achieved.

Table 3. Environmental Assessment Factors (Community facilities and services).

Environmental Assessment Factor	Impact Code	Impact Evaluation
COMMUNITY FACILITIES AND SERVICES		
Educational and Cultural Facilities	2	The proposed activity will have no direct, indirect or cumulative impact on educational or cultural facilities.
Commercial Facilities	1	The proposed activity will help to support commercial facilities owned by the Econo supermarket chain by providing secure facilities for storage of perishable items. It will allow it to have products available to the public during events of power outages. Thus, there is a direct beneficial impact to commercial facilities associated with the project.
Health Care and Social Services	2	The proposed activity will have no direct, indirect or cumulative impact on health care and social services.
Solid Waste Disposal / Recycling	2	New drying bed(s) will be constructed to treat sludge residues from wastewater. This unit will result in the generation of residues that will be either sent to a landfill or repurposed for other industries. The end point of this waste is being evaluated and will also depend on the composition of the waste. Sludge management will be implemented to address if the residues will be transported to a landfill or re-used in other applications such as animal feed or fertilizer. Either way, the company will take responsibility for handling residues according to applicable regulations.

		<p>If the sludge needs to be disposed of at a landfill, the facility operator will perform with a licensed operator to ensure proper disposal. Solid waste generation permits will be needed, and the owner/operator will be responsible for obtaining said permits and payment of all fees.</p> <p>In addition to sludge, industrial equipment maintenance generates various waste streams that will be managed to comply with environmental regulations. These waste streams can include oils, lubricants, solvents, coolants, paints, and contaminated cleaning rags or filters, as well as metal shavings or debris. As the site is an operating facility, it has provisions to handle waste streams through contracted companies that collect the waste and dispose according to regulatory requirements. Waste will be characterized and disposed of according to regulations. Whenever possible, waste recycling will be evaluated and pursued. The facility already has authorization as facility for storage of oil (2023-490029-PAU-005279) and is subject to compliance under the Reglamento para el Manejo de Desperdicios Solidos No Peligrosos (RMDSNP).</p> <p>None of the proposed new components use refrigerant, thus no refrigerant management will result from the project.</p>
Waste Water / Sanitary Sewers	2	The project has been designed so that there is no wastewater generation, instead wastewater will be treated in and recirculated through the new units. Thus, there will be no discharge of wastewater to the environment. Purposefully the project has been designed to avoid discharges to the site's Underground Injection Control (UIC) system, which handles waste and sanitary water from the site. The proposed actions will deviate the liquid waste from the UIC system, to avoid overloading it. It should be noted that the site has an active Underground Injection Control (UIC) permit to operate from the DNER.
Water Supply	2	The project will not require the use of potable water, thus there is no impact to the public water supply from the proposed activity.
Public Safety - Police, Fire and Emergency Medical	2	The Project will not have any impact on public safety. The site is monitored 24 hours each day by private security systems. There are also fire control systems in place and a brigade, trained to address emergencies at the facility, will be activated in case of an emergency before any public services are used. This is intended for the safety and security of the personnel working at the site and to provide quick response in an emergency.
Parks, Open Space and Recreation	2	The proposed activity will have no direct, indirect or cumulative impact on parks, open space and recreation facilities.
Transportation and Accessibility	2	Since the project will be developed within the existing facilities of Econo, the proposed activity will have no direct, indirect or cumulative impact on transportation and accessibility outside

	the project and will not impact residents from nearby communities.
--	--

Table 4. Environmental Assessment Factors (Natural Features).

Environmental Assessment Factor	Impact Code	Impact Evaluation
NATURAL FEATURES		
Unique Natural Features, Water Resources	2	The project area does not harbor any unique natural features because the activities will occur within an industrial site. Thus, natural features in the area have been impacted and eliminated during previous site construction activities. Also, no water resources will be impacted by the action during the construction or operation of the facility.
Vegetation, Wildlife	2	The proposed activity will not have a direct or indirect impact on existing vegetation or wildlife. This is because the current conditions of the project area do not support any wildlife or vegetation because it has been developed for industrial use. The only vegetation is common grass that was planted in part of the facility for aesthetic reasons and to stabilize the soil and prevent erosion. Therefore, there will be no impact on existing vegetation or wildlife.
Other Factors	2	There are no other environmental factors that need to be addressed.

Table 5. Environmental Assessment Factors (Climate and Energy).

Environmental Assessment Factor	Impact Code	Impact Evaluation
CLIMATE AND ENERGY		
Climate Change Impacts	2	The project is being developed to ensure the facility is resilient when disasters related to climate change occur, such as hurricanes or droughts. The project aligns with HUD guidance to mitigate and adapt to climate change. The project will add de minimis emissions and use of sustainable energy to ensure continuity of services, such as solar. Additionally, the project will significantly reduce the carbon footprint by utilizing renewable energy and natural gas, in place of the fuels used by the Puerto Rico Electric Power Authority. Furthermore, it ensures food security through the distribution of food to the population.
Energy Efficiency	1	The project will meet current federal and local codes concerning energy consumption. Construction machinery will not be connected to the grid, so minimal to no impact

		<p>is expected during the construction period. The project site is served by LUMA, who serves the existing infrastructure at the site. The project is intended to increase the site's energy efficiency and thus reduce energy consumption from the grid. No utility disruptions are anticipated during construction. The site will comply with LUMA's recommendations and/or requirements of the electrical system connection.</p>
--	--	---

Additional Studies Performed: No studies have been performed to date.

Field Inspection (Date and completed by):

June 17, 2024, site visit by Héctor L Sánchez-Cruz, PE. The site was under operation, and it was a clear, sunny day. Access to all areas the project will impact on was provided, including access to the roof. The site has been developed and includes features of a commercial facility. Photographs from the site inspection are included in Appendix 9, as presented in the information related to Endangered Species Act.

List of Sources, Agencies and Persons Consulted [40 CFR 1508.9(b)]:

- US Department of Agriculture, Natural Resources Conservation Service, Web Soil Service, Farmland classification, accessed 7/17/2024 <https://websoilsurvey.nrcs.usda.gov/app/>
- US Environmental Protection Agency.
 - NEPA assist <https://www.epa.gov/nepa/nepassist>
 - EJ Screen <https://www.epa.gov/ejscreen>
 - Nonattainment Areas for Criteria Pollutants (Green Book) <https://www.epa.gov/green-book>
- US Fish and Wildlife Service
 - Wetland mapper, <https://www.fws.gov/program/national-wetlands-inventory/wetlands-mapper>
 - Information for Planning and Consultation (IPaC) <https://ipac.ecosphere.fws.gov/>
- Puerto Rico Planning Board <https://gis.jp.pr.gov/mipr/>
- Puerto Rico State Historic Preservation Office – direct consultation
- HUD tool: <https://www.hudexchange.info/programs/environmental-review/asd-calculator/>
- US Census: <https://tigerweb.geo.census.gov/tigerweb/>

List of Permits Obtained:

The facility already has authorization as facility for storage of oil (2023-490029-PAU-005279).

Public Outreach [24 CFR 50.23 & 58.43]:

As a result of the Environmental Review process, a combined public notice for the proposed project, *Finding of No Significant Impact and Notice of Intent to Request Release of Funds* (FONSI-NOI-RROF), will be published by the PRDOH. This notice will have a Spanish translation. Any substantive comments received will be addressed and incorporated into the final environmental review record (ERR).

Cumulative Impact Analysis [24 CFR 58.32]:

The proposed project will not contribute to adverse cumulative impacts on environmental resources. The site underwent intensive soil level alteration and leveling during its construction, which occurred between 2019 and 2021. At which time, impacts on natural resources occurred and were mitigated to obtain all the necessary construction and operation permits. The site is an existing, permitted, air emission source and while the proposed project will increase emissions, these are projected to be below the levels that would contribute to creating an unattainable area. Furthermore, the surrounding areas are not contributing to air emissions in such a way that the combination of these will increase pollutants in a harmful way. The surrounding areas are mostly residential, shopping centers, horse stables and horse racetrack.

Cumulatively, the proposed action may have a temporary impact on air quality, noise, traffic, and surface waters during construction activities, but will have a net long-term benefit to the human environment at the local and regional level. The proposed action will improve economic activity and food supply security once completed. The proposed actions are not anticipated to substantially contribute to further adverse cumulative environmental effects.

Alternatives [24 CFR 58.40(e); 40 CFR 1508.9]

To improve the energy supply at the facility, there were several alternatives considered. The main alternative was centered on the usage of a photovoltaic system, but on its own, the system would not suffice to serve as an energy source for the facility or a much larger system would have to be installed. Another alternative was to install a natural-gas powered electric generator unit on its own or install several of these. However, this would have required larger gas storage capacity for prolonged use. The use of natural gas, according to the US Energy Information Administration¹ (USEIA), “results in fewer emissions of nearly all types of air pollutants and CO₂, than burning coal or petroleum products to produce an equal amount of energy.” This makes the use of natural gas more favorable to meet air emissions regulation, and by extension, will have less impact in air quality of the area. Thus, the use of natural gas was always considered as a favorable alternative.

¹ <https://www.eia.gov/energyexplained/natural-gas/natural-gas-and-the-environment.php#:~:text=Natural%20gas%20has%20many%20qualities,burning%2C%20and%20economical%20energy%20source>. Accessed Sept 15, 2024

In addition to photovoltaic systems and natural gas, no other alternatives were considered. In the end, after evaluating the possibilities, a combination of both of these was deemed as the most favorable for the needs of the facility, the availability of raw materials and the complexity of the operations.

No Action Alternative [24 CFR 58.40(e)]:

A No Action Alternative was considered; however, this would not result in improved energy supply conditions at the site and thus limit the long-term food supply and availability. Also, a No Action Alternative will fail to meet the purpose and need of the project (energy stability) and does not contribute to PRDOH's goals under the CDBG-MIT Action Plan (Final Version approved by HUD and became effective on August 1, 2024).

Summary of Findings and Conclusions:

The proposed action involves the construction and installation of industrial equipment to provide a back-up energy supply to an existing food warehouse facility in Canóvanas, Puerto Rico. The equipment includes photovoltaic panels, a natural-gas powered generator, gas-storage tank and its auxiliary equipment, energy battery backup, control room and other electrical components to tie-in the new systems with the existing operations. The new equipment system will also be tied to a wastewater processing setup with an evaporator that will produce distilled water. Waste from the evaporator will be diverted to a cooling tower and a concentrated wastewater processing unit will process its output in drying beds.

The project will occur in an existing industrial facility, thus there will be no impact to the natural environment due to fill or site elevation changes, other than the resulting air emissions and waste generation in the form of sludge. The infrastructure improvements within the project area will not result in additional flooding risk to other properties in the vicinity, will not affect any historic resources or affect endangered species or wetlands. There will be construction-related impacts that may be mitigated with best management practices. This includes impact due to noise, dust generation and increased air emissions due to increased operation of machinery. These impacts would be temporary and will affect the industrial site itself, as noise receptors are a little over 1 km to the East of the construction area.

Based on the analysis documented in this EA, construction and operation of the proposed action complies with applicable statutory authorities and will have no significant environmental impact.

Mitigation Measures and Conditions [40 CFR 1505.2(c)]

Summarize below all mitigation measures adopted by the Responsible Entity to reduce, avoid, or eliminate adverse environmental impacts and to avoid non-compliance or non-conformance with the above-listed authorities and factors. These measures/conditions must be incorporated into project contracts, development agreements, and other relevant documents. The staff responsible for implementing and monitoring mitigation measures should be clearly identified in the mitigation plan.

Law, Authority, or Factor	Mitigation Measures and Conditions
Clean Air Reglamento para el Control de la Contaminación Atmosférica (RCCA)	Per local regulations, the Department of Natural and Environmental Resources (DNER) will require an air emission source permit for the new facility. This will be managed according to the regulations of the agency which follow CAA regulation compliance, including compliance with National Emission Standards for Hazardous Air Pollutants (NESHAP). The project will adhere to compliance with RCCA (1995) and additional DNER and OGPe requirements.
Contamination and Toxic Substances Oil Pollution Prevention (40 CFR Part 112)	<ul style="list-style-type: none"> Since the new generator has an oil reservoir, estimated to be around 80 gallons, the site's Spill Prevention, Control, and Countermeasure (SPCC) plan, per 40 CFR Part 112, will be updated.
Endangered Species Act	The NLAA determination requires that Conservation Measures be implemented during the construction process. These are listed and included in Appendix 9 of this document and include dissemination of information of the species, construction site boundary delimitation, inspection of work area by experienced personnel, specific instructions on what to do if there is a boa sighting or identification within the construction area, and others. The contractor will develop and implement the plan for the site and execute the Conservation Measures. These measures also meet DNER requirements for management of the Puerto Rican boa (<i>Chilabothrus inornatus</i>). If a Puerto Rican Boa is found in the project action site, work shall cease until the Boa moves off on its own. If the Boa does not move off, the contractor shall contact the Puerto Rico Department of Natural and Environmental Resources and ask for them to relocate the boa.
Wetlands Protection under Executive Order 11990 and 24 CFR Part 55.10	Best management practices (BMPs) to control and minimize erosion and sedimentation must be implemented within the project.
Facilities and Services (Solid Waste Disposal)	According to local regulations, a recycling plan for Construction and Demolition (C&D) debris will be required by the Department of Natural and Environmental Resources (DNER). C&D This will be developed by the contractor and submitted for agency approval prior to the start of construction.

	Also, the facility operator will update its waste management plans to incorporate waste generated from the operations of the new facility which basically is limited to sludge disposal. If needed, a waste generation permit will be obtained.
Conformance with Plans / Compatible Land Use and Zoning / Scale and Urban Design	The applicant and/or construction manager must obtain all required local and territorial building and environmental permits before beginning construction activities.
Occupational Safety and Health Administration (OSHA) regulations	OSHA regulations are centered around worker safety and will reduce worker-exposure to certain hazards. However, while compliance with OSHA regulations is a requirement for most construction projects, some projects can be exempted from OSHA regulations. The contractor, work and project conditions as well as the job hazard analysis, will determine if and which OSHA standards apply. The Responsible Entity (in this case PRDOH) will not impose construction conditions on the developers but will require that the OSHA construction standards be strictly followed whenever they apply. Thus, the contractor must establish which standard applies, based on the work and environmental conditions.

Determination:

Finding of No Significant Impact [24 CFR 58.40(g)(1); 40 CFR 1508.27]
The project will not result in a significant impact on the quality of the human environment.

Finding of Significant Impact [24 CFR 58.40(g)(2); 40 CFR 1508.27]
The project may significantly affect the quality of the human environment.

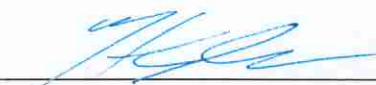
Preparer Signature:  Date: 12/16/2024

Name/Title/Organization: Hector L. Sanchez Cruz / Licensed engineer / SCA Consulting engineering

Certifying Officer Signature:  Date: 12/20/2024

Name/Title: Limary Vélez Marrero / Permits and Environmental Compliance Specialist

This original, signed document and related supporting material must be retained on file by the Responsible Entity in an Environmental Review Record (ERR) for the activity/project (ref: 24 CFR Part 58.38) and in accordance with recordkeeping requirements for the HUD program(s).

Appendices

1	1a Site location - Satellite image 1b Site location - Topographic Map
2	Project's Technical Proposal
3	Airport Hazards Map
4	Coastal Barrier Resources Map
5	Flood Insurance Rate Map
6	Clean Air data: Nonattainment/Maintenance Map EPA Green Book data Other data from designer and emissions calculations
7	Coastal Zone Boundary Map
8	Contamination and Toxic Substances Map Historical Images (8a – 8c) Facility Reports for identified sites Justification for the Infeasibility and Impracticability of Radon Testing
9	USFWS NLAA memo and support document
10	Explosive and Flammable Hazards
11	Farmland Protection Act
12	Floodplain management
13	SHPO Consultation Package
14	Sole Source Aquifers Map
15	Wetlands Map
16	Wild and Scenic Rivers Map
17	EJ Screen data
18	Zoning and Land Use

Appendix 1a

Site Location –Satellite image

Econo Energy Project

Project ID: IPGM-00375

Address: State Road PR-3, Int. PR 9959, Km. 15.21 Bo. Canovanillas, Canóvanas, PR. 00729

Coordinates: 18.373613° -65.906549° 



Source: Image from Google Earth Pro, image date 6/15/2023.

Appendix 1b

Site location -Topographic Map

Econo Energy Project

Project ID: IPGM-00375

Address: State Road PR-3, Int. PR 9959, Km. 15.21 Bo.
Canovanillas, Canóvanas, PR. 00729

Coordinates: 18.373613° -65.906549°

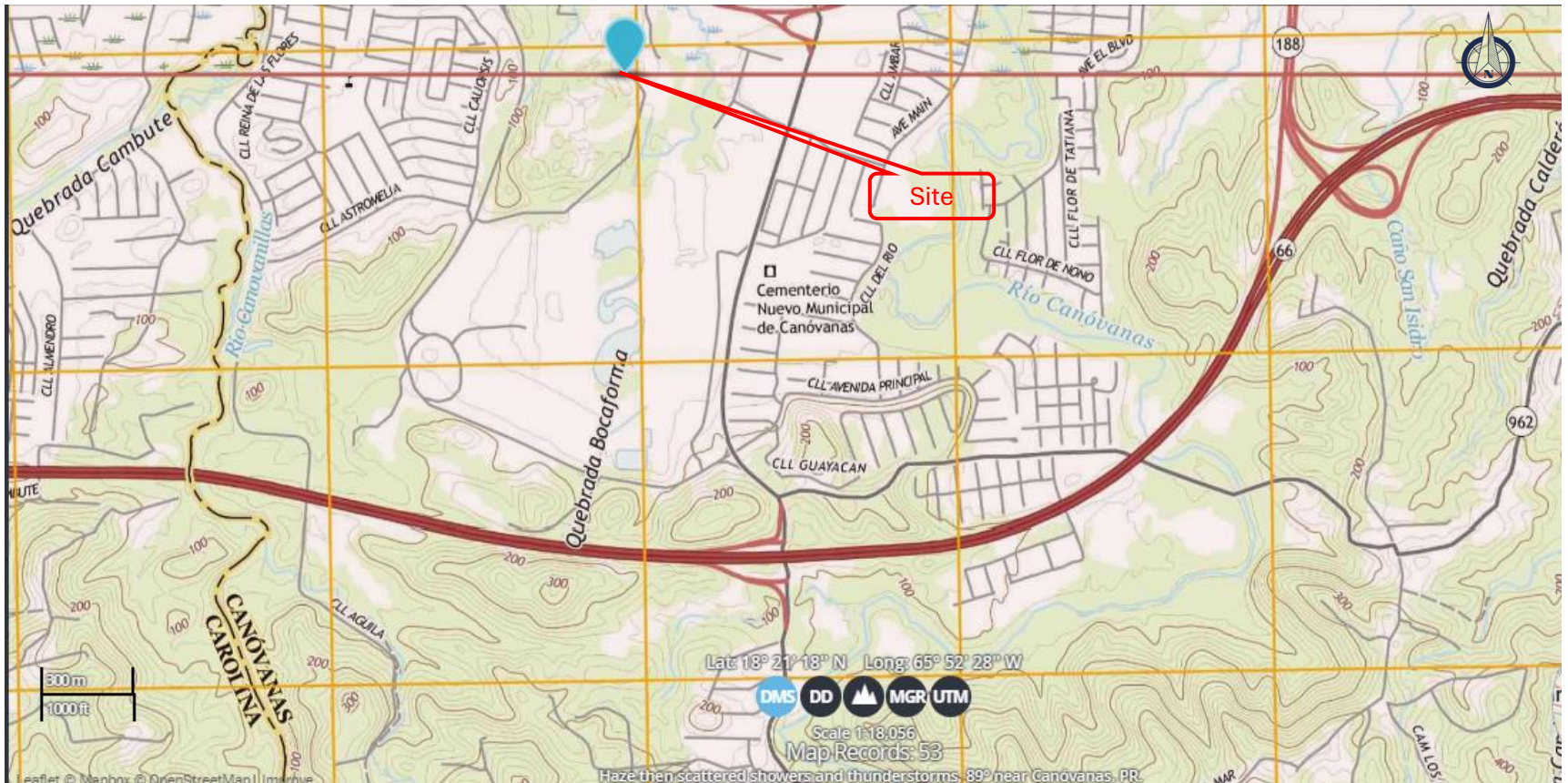

US Department of the Interior, US Geological Survey
Gurabo Quadrangle, 2018
Datum NAD83, Projection: TM

Source: <https://ngmdb.usgs.gov/topoview/> , accessed 6/1/2024

Appendix 2

Project 's Technical Proposal



SAMPOL
RELIABLE ENGINEERS

**HIGH EFFICIENCY HYBRID POWER PLANT
ECONO DISTRIBUTION CENTER
Canóvanas, Puerto Rico
SAM22-010374-18
September 2024**



SAMPOL



INDEX

1. SAMPOL GROUP
 - INTERNATIONAL PRESENCE
 - INTEGRAL SOLUTIONS
 - SAMPOL AND ENERGY
 - ESCO CONTRACTS
2. PROJECT SUMMARY
3. HIGH-EFFICIENCY HYBRID POWER PLANT ECONO DISTRIBUTION CENTER
 - TECHNICAL PROPOSAL – ENERGY FLOW
 - TECHNICAL PROPOSAL – PV PLANT
 - TECHNICAL PROPOSAL – HYBRID POWER PLANT
4. SAMPOL ECONOMIC PROPOSAL
5. DRAWINGS
6. SCOPE OF MATRIX
7. SCHEDULE





1 SAMPOL GROUP



About us

At SAMPOL we are a Spanish multinational group with over 85 years history.

Leaders in applied engineering projects with a special focus on energy, renewable energies, energy saving solutions, sustainability and digitization.

With strong presence in the industrial, hotel and airport sectors.



ENERGY AND
SUSTAINABILITY



INTEGRAL PROJECTS



DIGITAL



INDUSTRY



HOTELS



TRANSPORTS

More than 300 engineers integrate our human team



ENERGY AND SUSTAINABILITY

Energy plants which combine cogeneration with renewable energies and energy-saving solutions

Plants in ESCO/PPA as well as EPC modality

Experts in high energy efficiency systems which integrate photovoltaic, batteries, biogas, hydrogen or geothermal energy

Water: water management plants
Desalination, Purification, etc.

Energy and water integral management
We are responsible of the plants' operation and maintenance, offering all services to the client

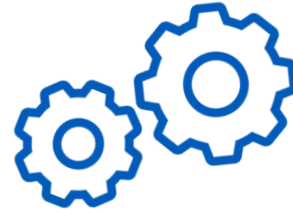

INTEGRAL PROJECTS

MEP installations Integral solutions for Electricity, HVAC, ACS, plumbing Networks, safety, fire protection Automation systems and SCADAS, hardware and software integration

Highly specialized in airport sector: Visual Aid Systems, Installations Control systems, Energy Control Systems, Aerial Navigation, Radio Aid Systems

High technic capability Complete project cycle from the design, planification and execution of the systems Commitment to technological innovation and integration

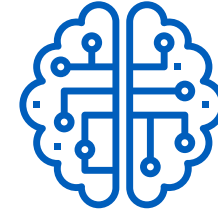

DIGITAL

Integration and development of IT solutions, products and services, which boost the digitalization processes of our clients

The scope of our expertise covers from networks and cybersafety to IoT, including our own software platforms and products for our markets

Leading the technology transformation with key solutions such as Optical Networks, Digital Twin and Specialized Cloud Applications Cloud (Icosaedro®) We focus our solutions on service mode (SaaS & IaaS) to ensure all the life cycle

14 COUNTRIES WHERE
WE HAVE
PERMANENT
PRESENCE

22 COUNTRIES IN
WHICH WE HAVE
CONDUCTED
PROJECTS

39% OF OUR TURNOVER
ABROAD

>30
COGENERATION
PLANTS

+1,500
EMPLOYEES
AROUND THE
WORLD

+1,000
MEGA WATIOS OF
INSTALLED ELECTRICAL
ENERGY

+4,000
COMPLETED
PROJECTS

International Presence



Spain



Italy



Mexico



Dominican Republic



Panama



Jamaica



Canada



Puerto Rico



Colombia



Cape Verde



Honduras



Peru



Guatemala

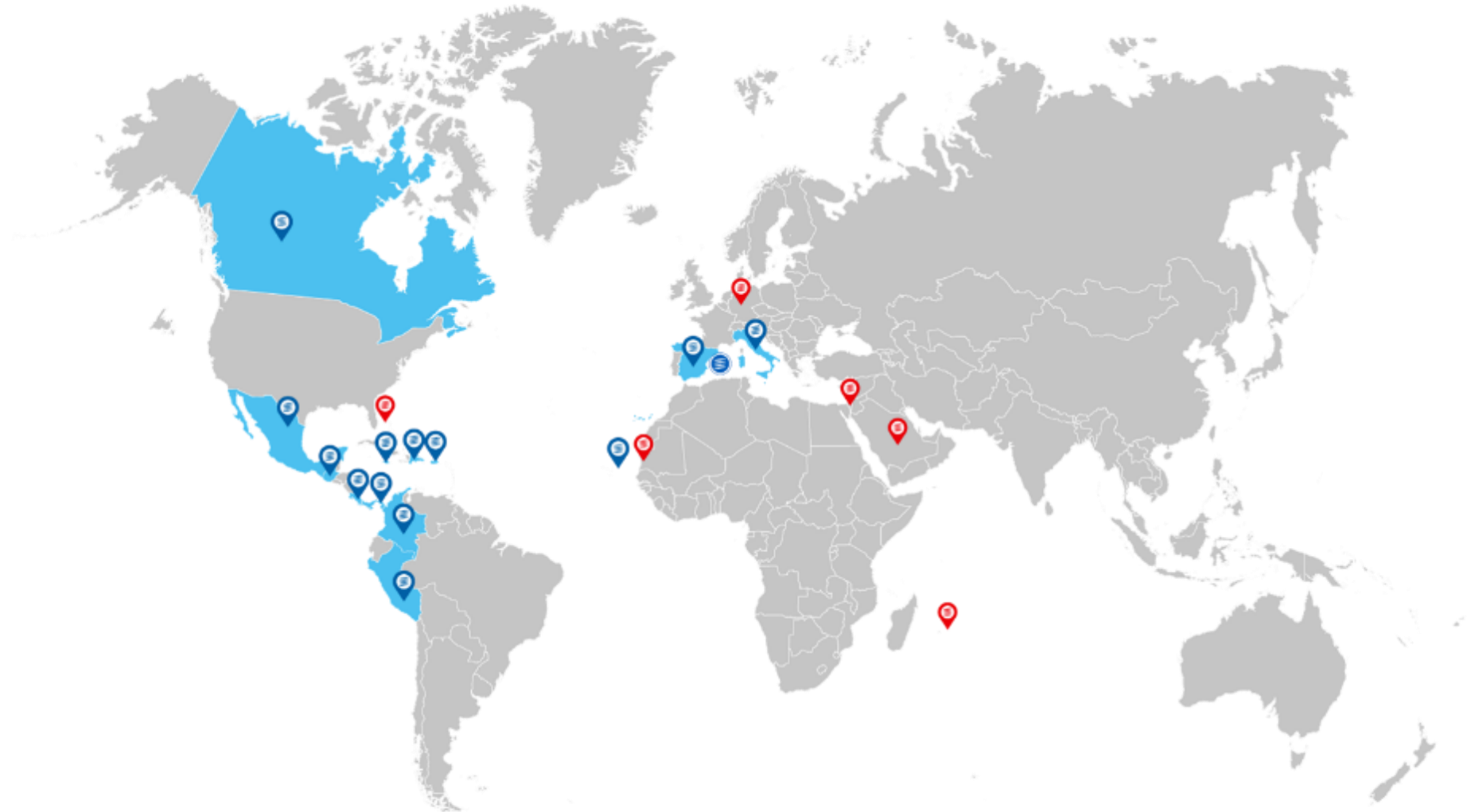

 Significant works

 Permanent presence

 Headquarters in Mallorca

Presence in Central America and the Caribbean



We develop **climate** actions

We **reduce** emissions

We **decrease** our clients' **carbon and hydric footprint**

We create **high energy efficiency** systems

We innovate with **green technologies**

We **digitalize** processes to achieve more **sustainable** solutions



ENERGY



30 YEARS OF EXPERIENCE

HYBRID PLANTS:
COGENERATION &
RENEWABLES



ENERGY
EFFICIENCY



PROJECTS
EPC & ESCO



SMART PLANT
MANAGEMENT



SMART O&M



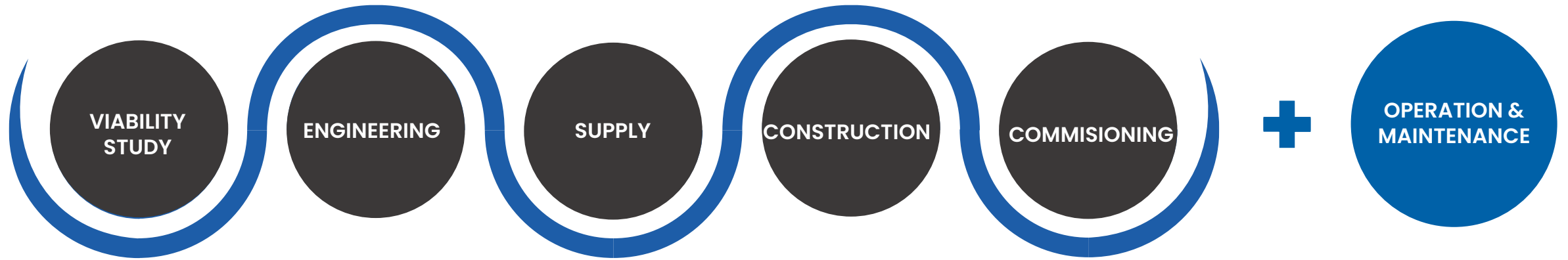

EPC

SAMPOL is responsible for the engineering, Development and construction of co/trigeneration plant

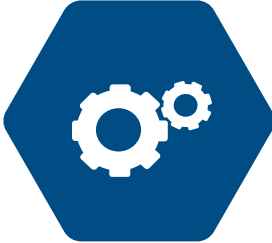

INVESTMENT

SAMPOL undertakes the investment of the project

ENERGY SUPPLY

SAMPOL ensures a reliable, efficient and secure energy supply

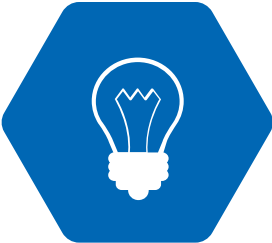

O&M

SAMPOL is responsible of the Operation and Maintenance of the installations





2 HIGH EFFICIENCY HYBRID POWER PLANT ECONO DISTRIBUTION CENTER

- **Facility location:** Canóvanas, Puerto Rico
- **Contract type:** Engineering, Procurement, and Construction (EPC)
- **Design:** Hybrid Power Plant: PV + Natural Gas Engine + BESS
- **Fuel:** Natural gas ; **Plant site elevation:** 55 ft. a.s.l.
- **Operation:** island mode / grid-tied
- **Energy demands:**
 - Night power consumption: 800 kWe
 - Day power consumption: 1,200 kWe
 - Demand 24/7
- **Current situation:**
 - Electricity consumption covered by LUMA
 - Diesel Back up engines power: 2 x 2500 kWe
- **SAMPOL proposal:**
 - High-Efficiency Hybrid Power Plant
 - Green Energy Production
 - H2-Ready
 - Carbon Footprint Reduction
 - Guaranteed availability and reliability
 - Economical savings

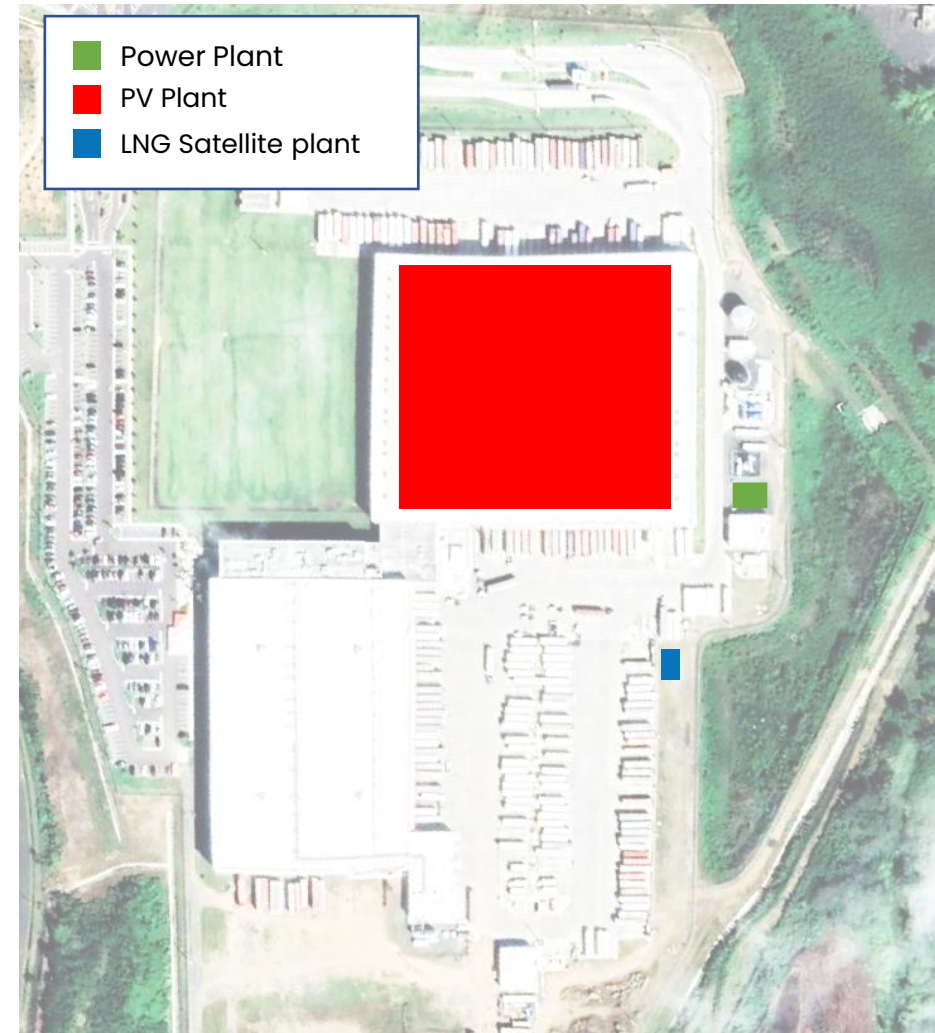

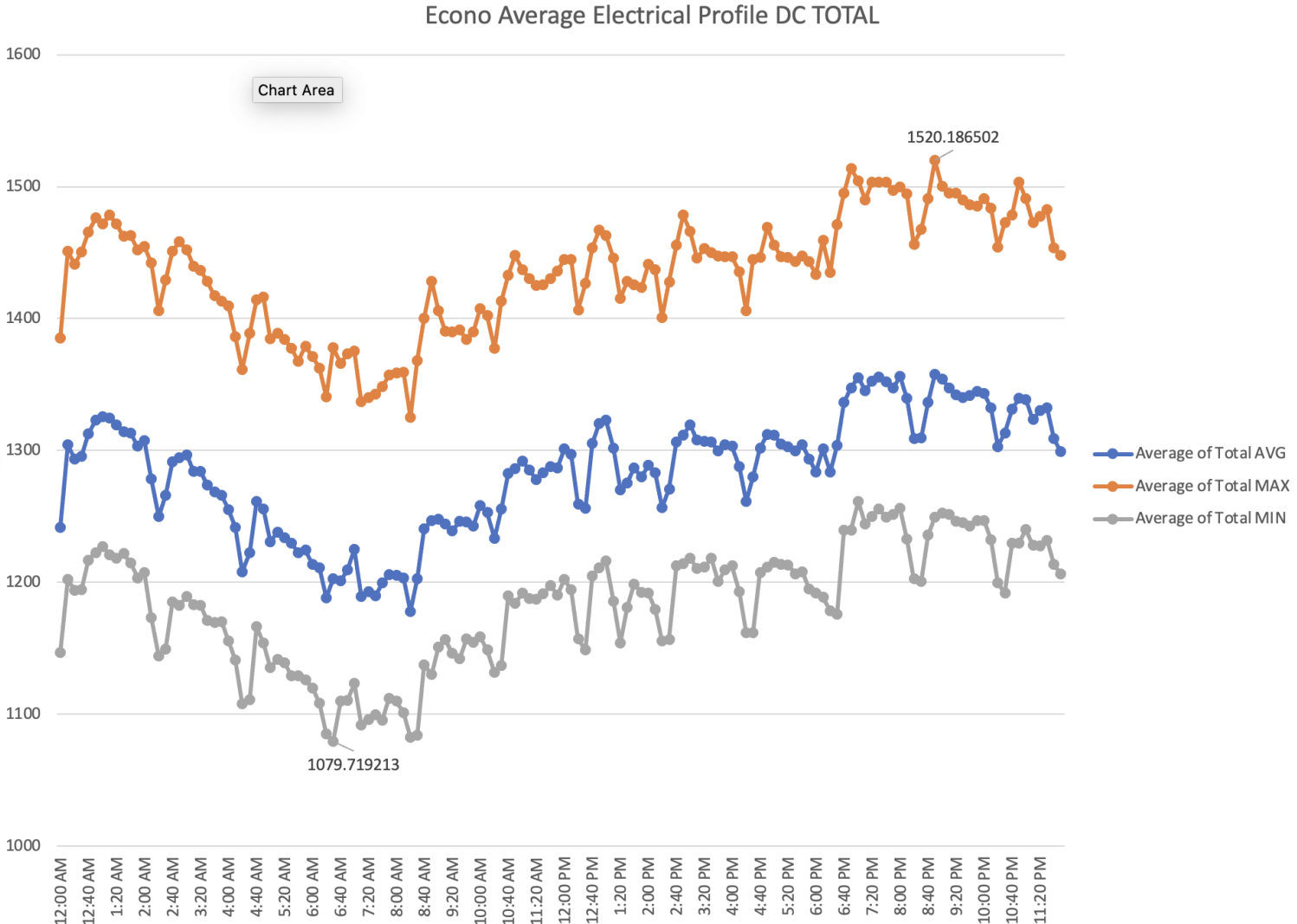



3 SAMPOL PROPOSAL

TECHNICAL PROPOSAL – ENERGY FLOW

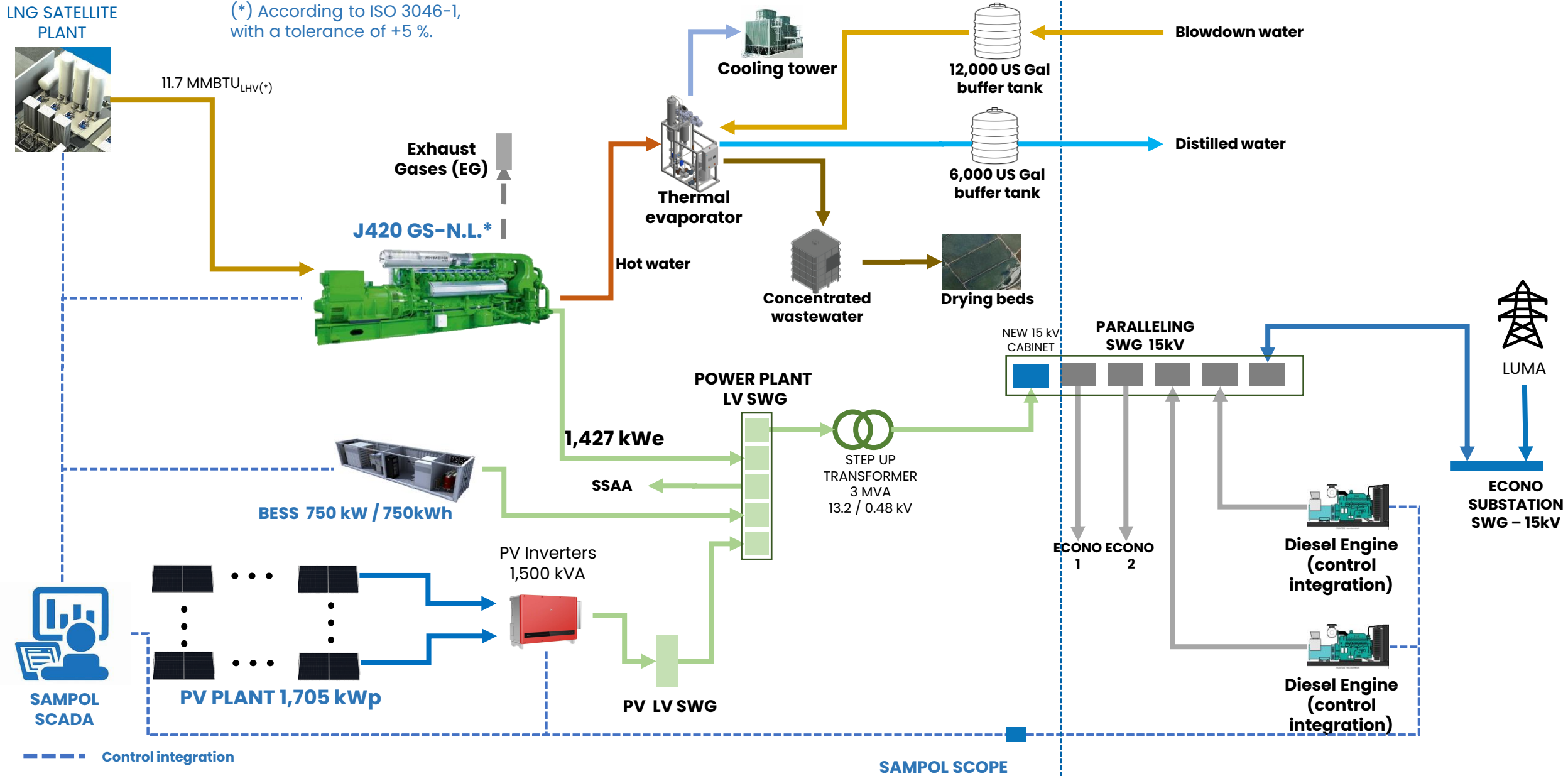

- **Design:** Photovoltaic Plant (PV) on roof connected to client installation
- **Location:** over flat roof; **Tilt:** coplanar to the roof
- **PV Plant peak power:** 1,705 kWp
- **PV Plant nominal power:** 1,500 kVA

MAIN EQUIPMENT

- 2,750 monocrystalline solar panels of 620 Wp*
- PV Inverters of 100 kVA*
- Equipment proposed as reference. The equipment will be defined during detailed engineering with similar quality and performance to the references

ELECTRICAL INSTALLATION

- CC and AC conduits, electrical protections. New LV PV SWITCHGEAR located indoor of client facilities.

PHOTOVOLTAIC STRUCTURE

- Steel support structure for coplanar installation with screws and steel anchors resistant against salt mist ambient
- Designed to resist winds velocities of 155 miles per hour.
- Structure installation will be coordinated with the contractor that guarantees the roof weatherproofing
- Structural approval of existing building for PV installation to be provided by Econo Structural Engineer.

CONSIDERATIONS

- PV inverters need internet access to control & monitoring
- No modifications of existing electrical installation considered
- Anchor-fixed system will be assumed by another contractor.
- Assumption made by Sampol: Structure of the building to support new PV installation. Customer to confirm structural engineering is complying.

PERFORMANCE

- **PV annual production estimation:** **2,825 MWh/year 0

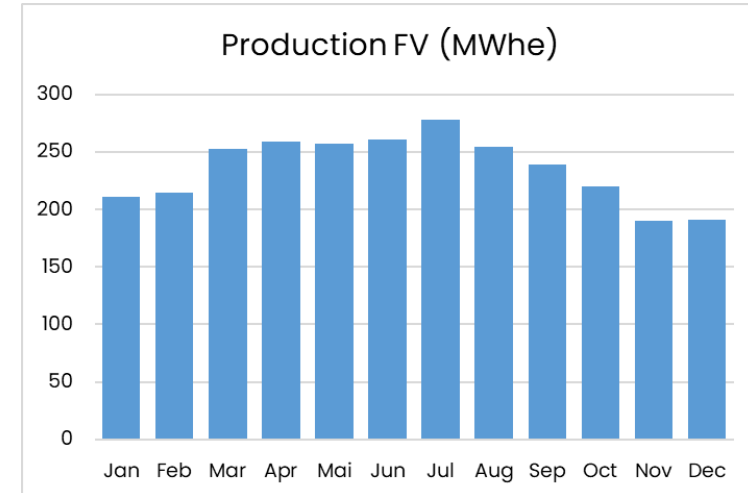

*Number and power of modules and inverters to be defined during detailed engineering respecting nominal and peak power

** The production is estimated for year 0 and based on NREL databases. More accurate estimation need detailed engineering, ambient local conditions and O&M conditions

HYBRID POWER GENERATION

- 1x Natural Gas Genset-Container **Jenbacher J420 GS-N.I**
 - Electrical power on site **1,427** kWe
 - Voltage generation: 480V, 60Hz
 - **Ready** to operate with **H2 up to 10%** per volume without losing any power
 - **Ready** to operate with **H2 up to 20%** per volume. The power operating with 20% H2 per volume is **1,336 kWe** and an electrical efficiency of 41.3%
- The engine can be converted in the future to operate 100% H2

LNG PLANT

- Storage tank – 20,000 USG (5 days autonomy – 1.3 MWe average demand)
- Vaporizers
- Pump skid

BRINE DRYING SYSTEM

- Thermal evaporator to reduce 6,000 Gal blowdown wastewater to 260 Gal concentrated wastewater, producing up to 5,740 Gal distilled water.
- Drying beds included to completely dry the concentrated wastewater.
- Auxiliary electric heater included to allow regular operation even when the engine is stopped.
- Post treatment to adapt the distilled water to the required characteristics.
- 12,000 Gal raw water buffer tank to increase autonomy.
- 6,000 Gal distilled water tank to allow usage management.

BESS

- LV BESS 750 kWh/ 750 kW

ELECTRICAL SYSTEM

- Control equipment to be located in a Container
- LV Plant SWG cabinets: PV, Genset, BESS, Auxiliary loads and output to Step-up transformer
- Step-Up Transformer 3,000kVA, 0.48/13.2kV installed in the Power Plant area
- 1 x HV cabinet to be installed in the existing Paralleling Switchgear – 15kV

CONTROL SYSTEM

- Distributed Control System, Control and monitoring of grid interconnection by HMI
- Remote operation, SCADA and visualization
- Operation desk to be located on LV & Control room
- BESS integration
- Existing Diesel integration

CIVIL WORKS

- Genset, BESS, LV electrical container, evaporator and water tanks foundations
- HV Cabinet to be installed inside Engine room at existing foundation
- Electrical canalization, considered using existing ones. Reserved spare conduits from control room to LNG station and future engine location.
- The removal of gravel from the Natural Gas Engine and LNG areas is contemplated for its subsequent reuse.
- Stormwater & CES planning included
- Retaining wall, access ladder, and cementation included in the LNG area.
- LNG station will include space and foundations for a future second LNG tank.
- Gas piping canalization to Natural Gas Engine including one spare conduit.
- Underground water piping including one spare pipe.
- Safety Fence considered
- Underground geo survey to be performed to determine any interferences with new pipping and trenches. Any existing underground utilities relocation if required, are not included
- Latest available Geotechnical study to be provided by Customer

CONSIDERATIONS

- Customer facilities have Water for Fire Protection System (acc. NFPA 850)
- Stack height up to 10 meters in order to comply with the requirements of Section 123 of the Clean Air Act subject. This stacks height is subject to in situ study during basic engineering
- Permits with government excluded and needs to be managed by Customer. All supporting documentation including professional drawing stamps will be provided by Sampol
- Sampol Civil proposal is based on a bearing load capacity of 1.5 kg/cm² (3,000 psf)

SOLAR PANEL		
Manufacture	LONGI	
Module type	LR7-72HGD-620M	
Cell material	Monocrystalline	
Module construction	Bifacial	
Power (STC)	620	Wp
Open Voltage (Voc)	52.77	V
Short Circuit Current (Isc)	14.85	A
Voltage at Maximum Power (Vmp)	44.33	V
Current at Maximum Power (Imp)	13.99	A
Efficiency	23%	
Dimension	2382 x 1134 x 30	mm
Weight	33.5	kg
J-BOX	IP68	
IEC 61701	Salt mist corrosion	
Materials and Processing Warranty	12	Years
Performance Warranty	30	years

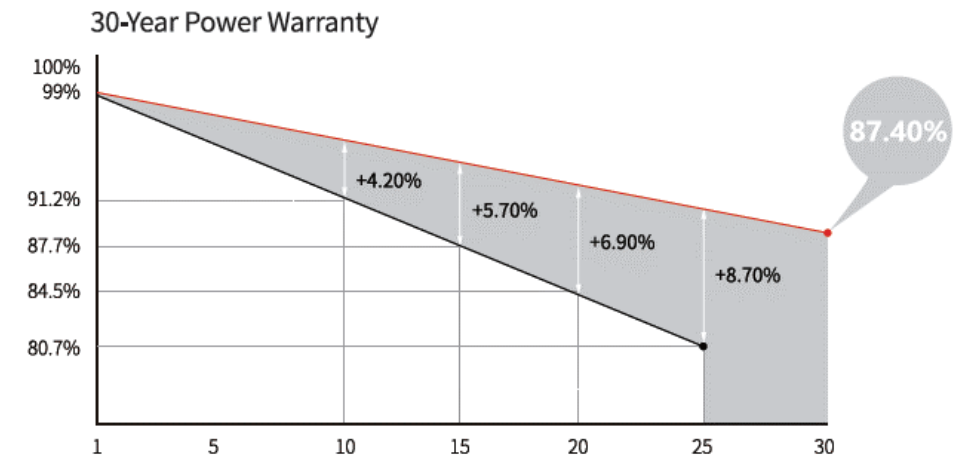
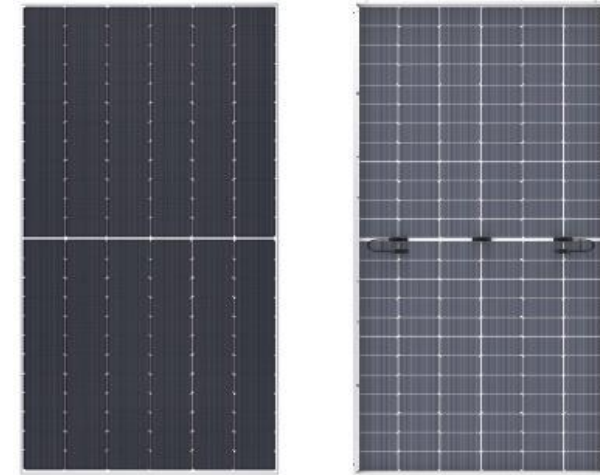

PV INVERTER		
MANUFACTURE		GOODWE
Model		GW100KHT
Power AC output	kVA	100
DC Voltage in	V	1000
Number of MPP trackers		10
Efficiency		98.6%
Dimension	mm	1008 x 678 x 343



BESS	
Power	750 kW
Capacity	750 kWh
Technology	Narada lithium battery
Efficiency	97%
Dimensions	40 ft container (8' w x 8'6 h x 40' l)
Protection	IP54



GENSET “Ready for H2”

Engine Type	JGC 420 GS-N.L	
Fuel	Natural Gas	
Number of cylinder	20	
Mechanical power (on site)⁽ⁱ⁾	1,466	kWm
Rated power (on site)⁽ⁱⁱ⁾	1,427	kWe
Fuel gas consumption⁽ⁱⁱⁱ⁾	11.64	MMBtu_lhv
Nominal Efficiency (on site)	41.8	%
Voltage	480	V
Frequency	60	Hz

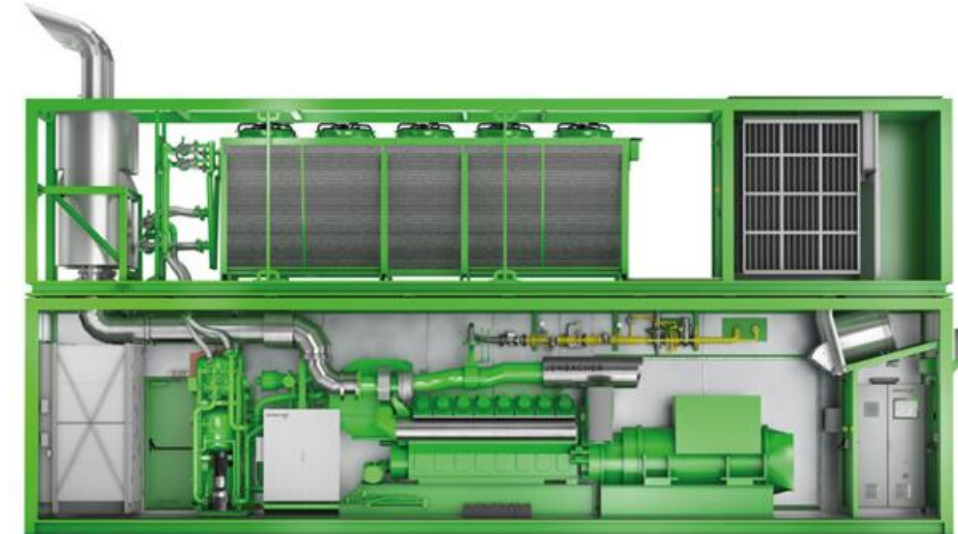

- (i) At nominal speed and standard reference conditions ICFN according to ISO 3046-1, respectively*
- (ii) At p. f. = 1.0 according to IEC 60034-1:2017*
- (iii) According to ISO 3046-1, respectively, with a tolerance of +5 %*

Ready to operate with **H2 up to 10%** per volume without losing any power
Ready to operate with **H2 up to 20%** per volume

BRINE DRYING SYSTEM	
Inlet water	23 m ³ /day
Distilled water	22 m ³ /day
Concentrated wastewater	1 m ³ /day
Thermal consumption	362 kW
Electrical consumption	17 kW
Salt residue in distilled water	<4 ppm
Protection against corrosion	Yes
Auxiliary Natural Gas Heater	400 kW water heater protected against corrosion
Post treatment	pH and salinity control
Raw water buffer tank	12,000 Gal (2 days autonomy)
Threated water tank	6,000 Gal

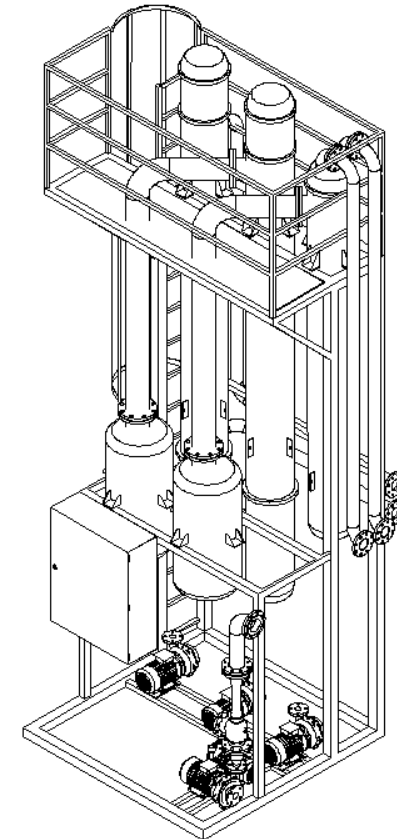



5 DRAWINGS

PARALLELING SWITCHGEAR - 15kV

TO SUBSTATION
SWITCHGEAR 15kV

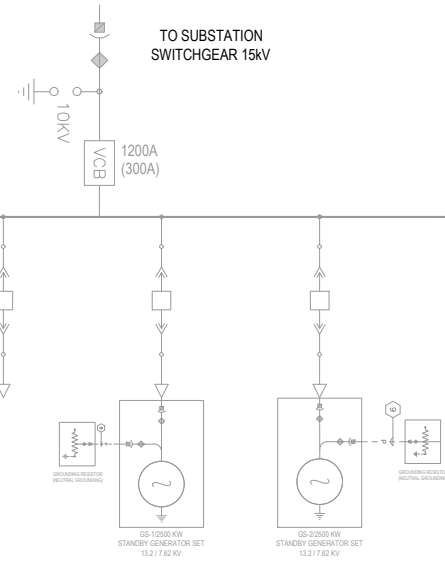

52 L1
600 A

T-LV/HV
3,000 kVA
13,200 V / 480 V

52 - L1
4000 A

ECONO HYBRID POWER PLANT LV SWG (MDB)
4000A, 480V, 3Ph, 4W, 85kAIC

Photovoltaic Plant 1,705 kWp

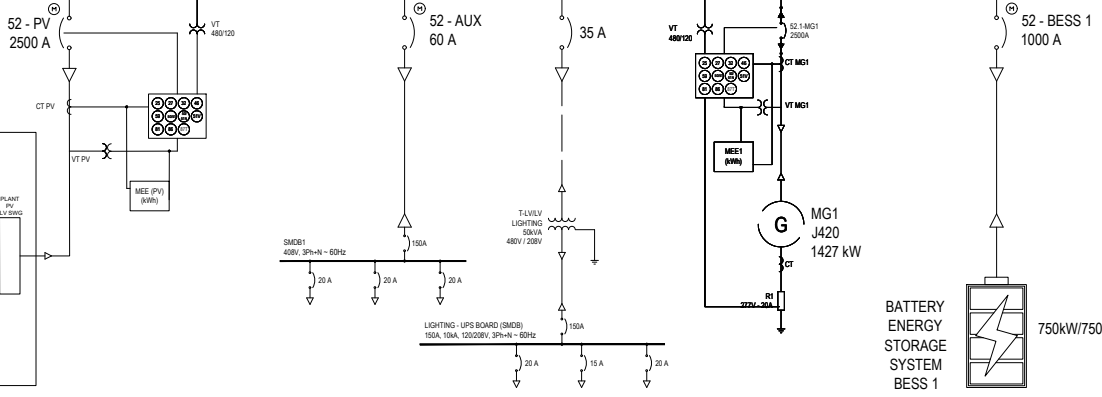
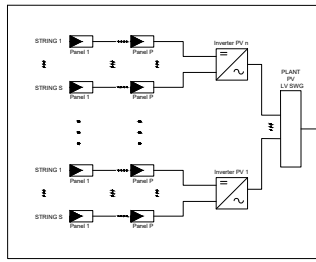

SCOPE OF SUPPLY LIMIT

SAMPOL  OTHERS

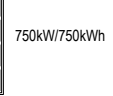

Client: HIGH EFFICIENCY HYBRID POWER PLANT
ECONO DISTRIBUTION CENTER

Project: SINGLE LINE DIAGRAM

Title: ECO-ELE-01-01-E18

Nº drawing: PRELIMINAR DESIGN SUBJECTED TO MODIFICATIONS
DURING THE PROJECT

Comments: Scale: N/S
Date: September 2024

Canóvanas (Puerto Rico)

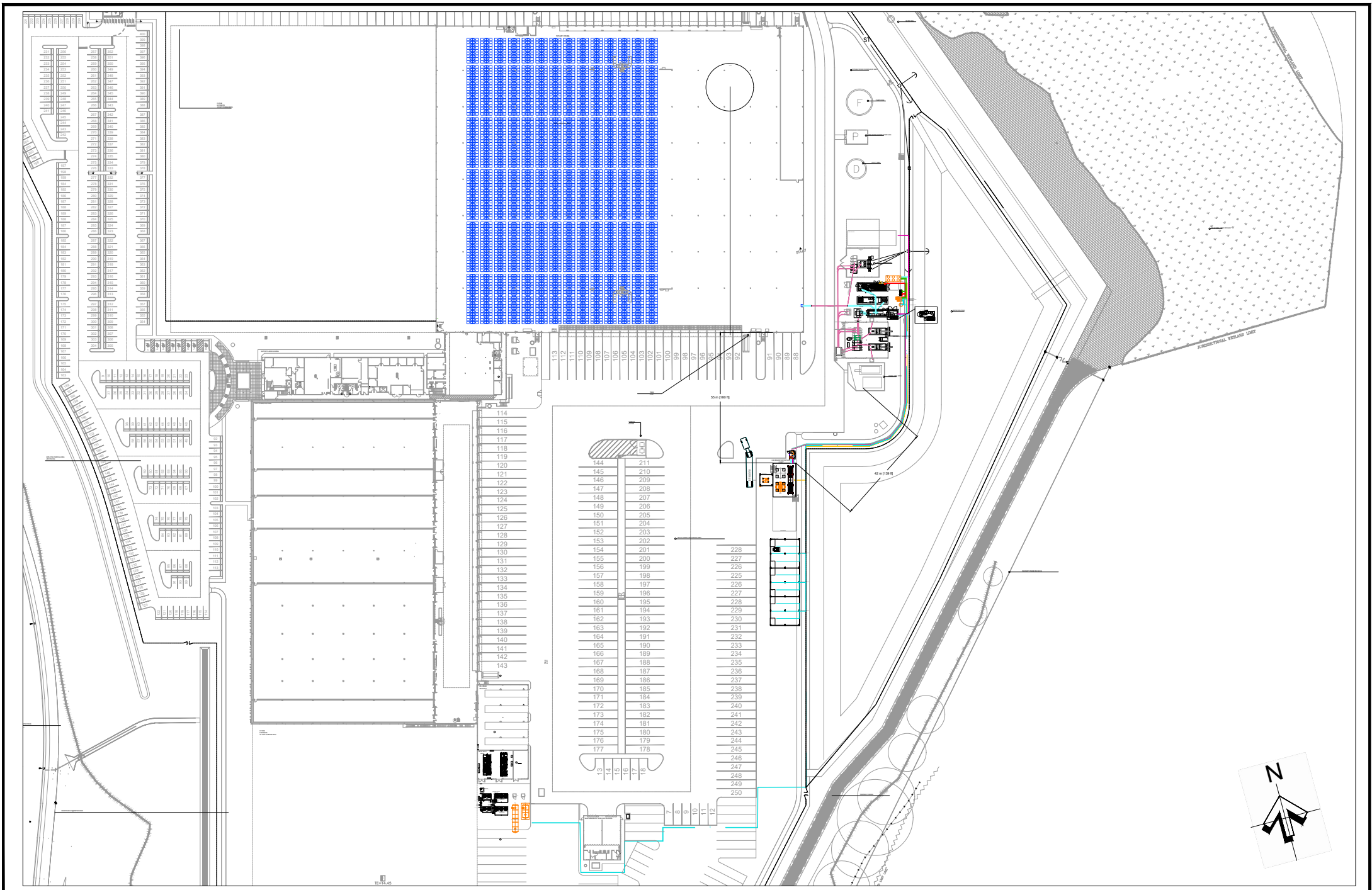

Client: **ECONO**
 Project: **HIGH EFFICIENCY HYBRID POWER PLANT
 ECONO DISTRIBUTION CENTER**
Canóvanas (Puerto Rico)

Title: **MASTER LAYOUT**

Nº drawing: **ECO-GEN-02-01-E18**

Comments: **PRELIMINAR DESIGN SUBJECTED TO MODIFICATIONS
 DURING THE PROJECT**

Scale: **1:2000**
 Date: **September 2024**

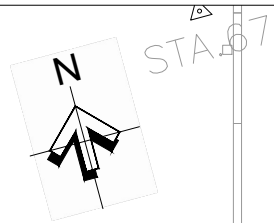

STA. 67

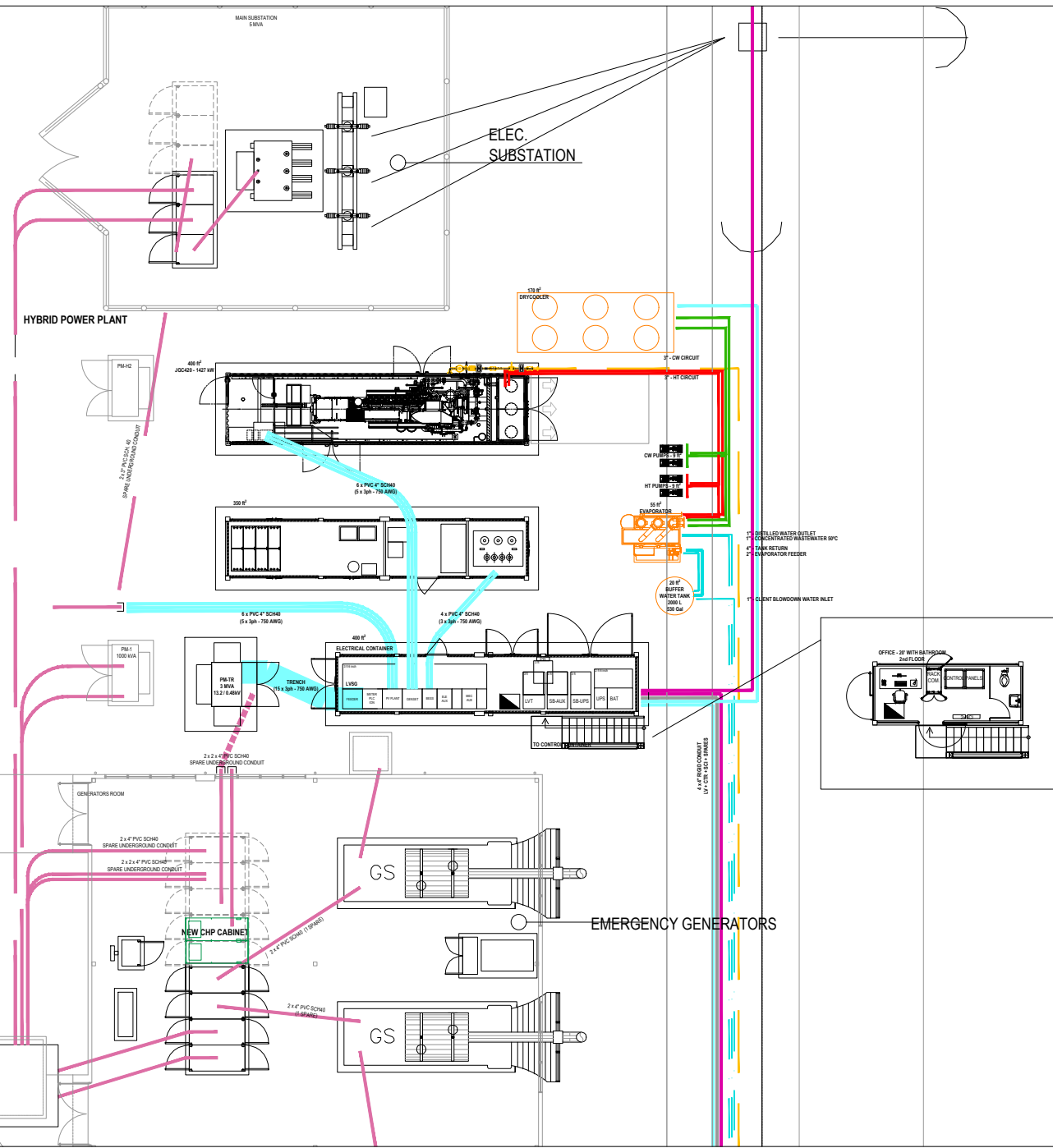

Client: HIGH EFFICIENCY HYBRID POWER PLANT
ECONO DISTRIBUTION CENTER
Canóvanas (Puerto Rico)

Title: LAYOUT POWER PLANT

Nº drawing: ECO-GEN-02-02-E18

Comments: PRELIMINAR DESIGN SUBJECTED TO MODIFICATIONS DURING THE PROJECT

Scale: 1:250
Date: September 2024



2,750 solar panels 620 Wp
PV PLANT 1,705 kWp

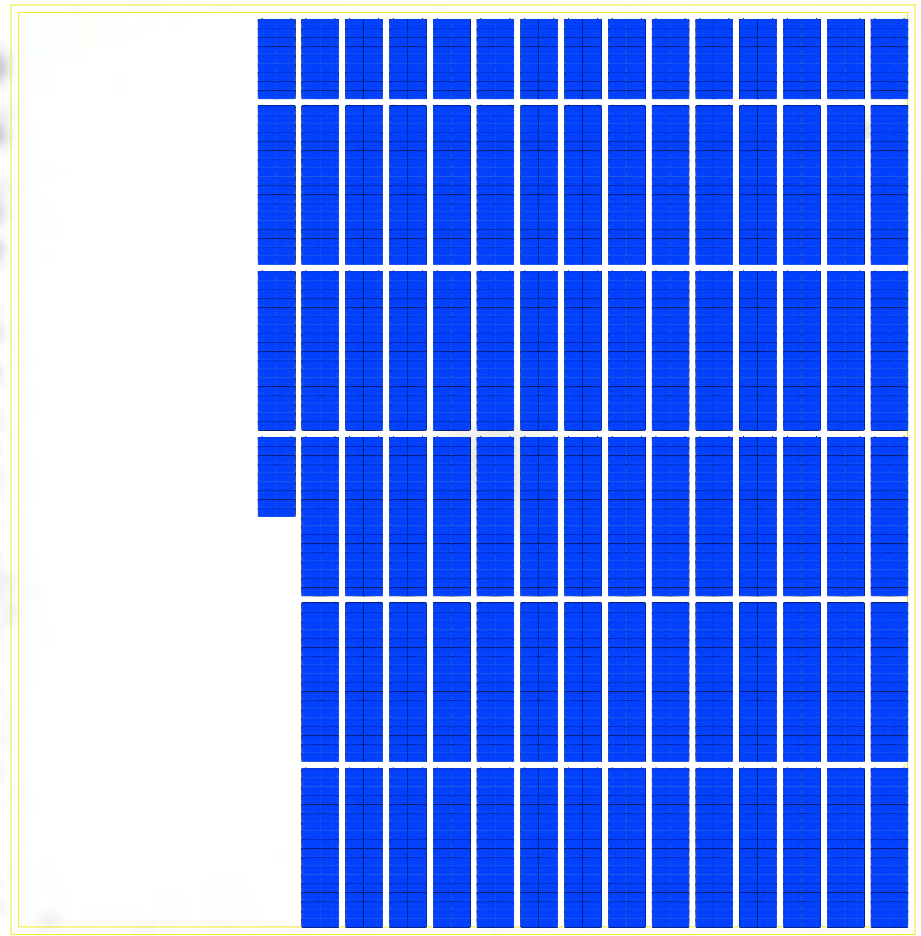

LAYOUT
E: 1:1000

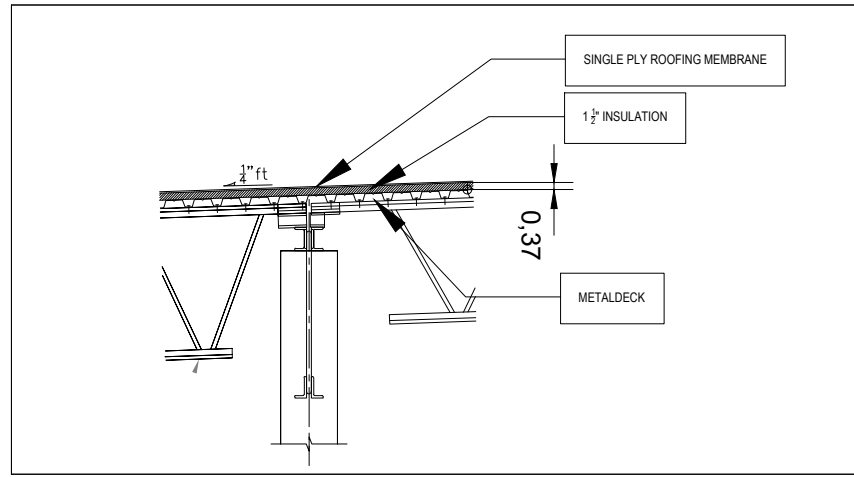

ROOF CONSTRUCTION DETAILS



Roof pictures



Construction roof support

2,750 solar panels 620 Wp

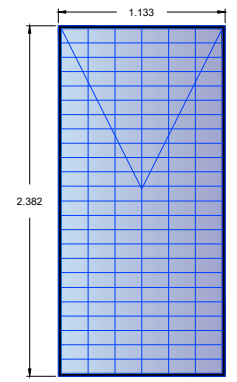

LONGI LR7-72HGD-620M



Client: SOLAR POWER PLANT
1.7 MWp
Canóvanas (Puerto Rico)

Title: PV LAYOUT

Nº drawing: ECO-GEN-02-03-E18

Comments: PRELIMINAR DESIGN SUBJECTED TO MODIFICATIONS
DURING THE PROJECT

Scale: 1:1000
Date: September 2024

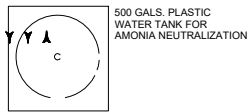

EXISTING AMONIA CHILLER PLANT

COOLING TOWERS

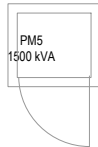
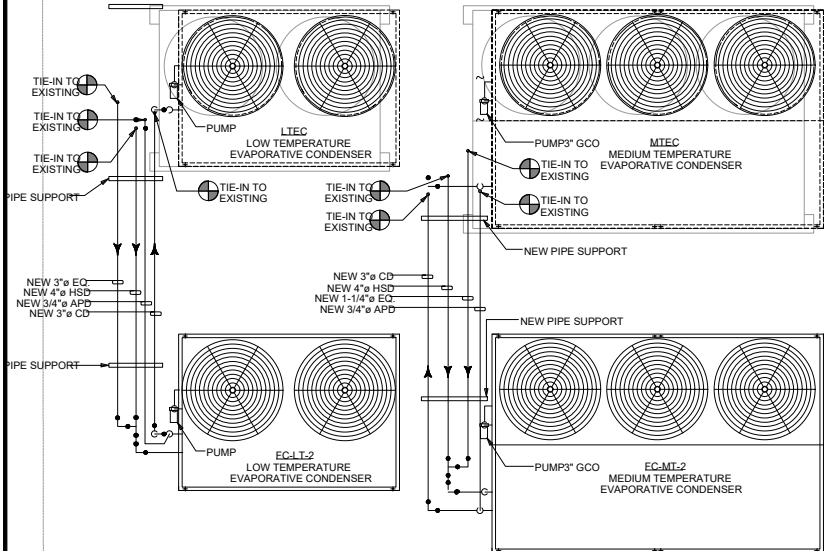

PM4

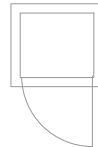

320 ft²

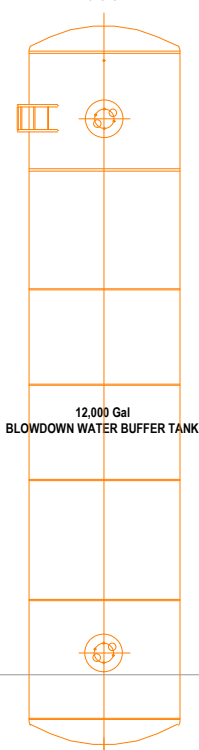

12,000 Gal
BLOWDOWN WATER BUFFER TANK

160 ft²

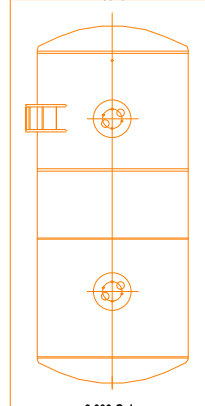

6,000 Gal
ACONTIONED WATER BUFFER TANK

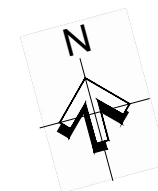

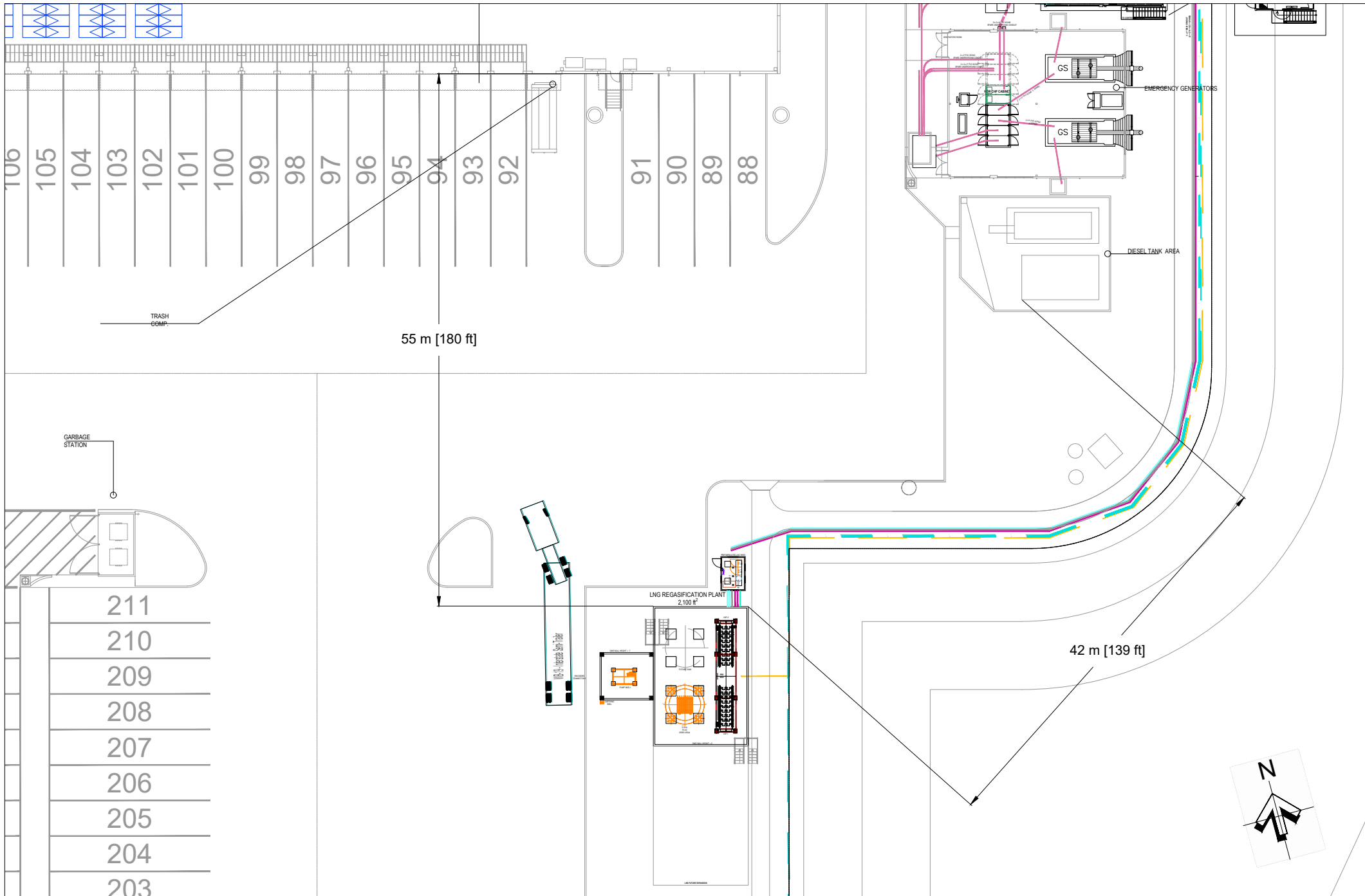



6 SCOPE OF SUPPLY



	ITEMS	SAMPOL CLIENT		NOTES
1 GENERATING SET				
1,1	Jenbacher Genset JGC 420 GS-N.L.	X		1 unit, standard Jenbacher containerized unit
1,2	Flexible connections between engine and external piping	X		
1,3	Generator 480V; 60 Hz	X		
1,4	Flywheel cover	X		
1,5	Container unit	X		
2 MECHANICAL AUXILIARY SYSTEMS				
2.1 NATURAL GAS SYSTEM				
2.1.1	LNG Storage & Regas satellite station	X		20,000 USG tank
2.1.2	Vaporizers	X		2 x 100%
2.1.3	Truck Unloading Skid	X		
2.1.4	Pressure Control Skid	X		
2.1.5	Air compressed system	X		
2.1.6	Engine flow meter	X		1 unit
2.1.7	Piping, valves and instrumentation between LNG regasification plant to engine	X		Natural Gas pipe: up to 130 m from Engine to proposed LNG Storage area. One spare LNG pipe included.
2.1.8	Engine gas train	X		1 unit
2.1.9	Electrical interconnection of LNG plant	X		
2.2 LUBRICATING OIL SYSTEM				
2.2.1	Lube oil tank inside genset container	X		
2.2.2	Power Plant Lube oil tank		X	If required
2.2.3	Electric Driven Oil Pump	X		1 x genset container
2.2.4	Level switches	X		1 x genset container
2.2.5	Shut-off devices	X		1 x genset container
2.2.6	Pipework between oil tank and module	X		within genset container
2.3 DUAL CIRCUIT COOLING SYSTEM				
2.3.1	Dry coolers for HT & LT	X		
2.3.2	Cooling Pumps	X		1 x genset container
2.3.3	Expansion tanks	X		
2.3.4	Piping, valves and instrumentation	X		
2.4 EXHAUST GAS SYSTEM				
2.4.1	Exhaust gas preventilation system	X		
2.4.2	Flexible compensators in turbocharger	X		
2.4.3	Exhaust gas silencer	X		
2.4.4	Exhaust gas ducting	X		
2.4.5	Exhaust gas stack	X		10 mts Considered. Stack height compliance with the requirements of Section 123 of the Clean Air Act is subject to in situ study during basic engineering.
2.4.6	Bellows, spiral wound gaskets, clamps and accessories	X		
2.4.7	Thermal insulation	X		
2.4.8	Selective Catalytic Reduction system or continuous monitoring system		X	If required
2.5 INTAKE AIR SYSTEM				
2.5.1	Charge air fans	X		
2.5.2	Charge air filters	X		
2.5.3	Charge air silencer	X		
2.6 VENTILATION				
2.6.1	Inlet air silencer	X		
2.6.2	Inlet air filters	X		
2.6.3	Inlet air impulsion fan	X		
2.6.4	Outlet air silencer	X		
2.6.5	Ducts and accessories	X		
2.7 FIRE PROTECTION SYSTEM				
2.7.1	Fire pump station		X	
2.7.2	Fire / raw water tank		X	
2.7.3	Hose cabinets		X	
2.7.4	Interconnection with underground fire hydrant system		X	Hybrid Power Plant will be covered by the existing Firefighting System
2.7.5	Fire hydrant system		X	
2.7.6	Portable fire extinguishers	X		
2.7.7	Fire detection and alarm system	X		Located at container-genset, BESS containers and Electrical & Control Container
2.7.8	Gas detection and alarm system	X		Located at container-genset



	ITEMS	SAMPOL CLIENT		NOTES
2.8 PLANT'S AUXILIARY INSTALLATIONS				
2.8.1	City water network within the plant's boundaries	X	X	Client to supply city water for operation and maintenance purposes on boundary limits of Power Plant. Sampol is responsible for connection if needed
2.8.2	Sewage system connection	X	X	Utility by Owner, connection by contractor
2.9 BRINE DRYING SYSTEM				
2.9.1	Engine HT thermal recovery heat exchanger	X		1 unit
2.9.2	Heat recovery brine evaporator	X		1 unit protected against corrosion
2.9.3	Dry coolers for thermal evaporator	X		1 unit protected against corrosion
2.9.4	Piping system, valves and instruments - HT system	X		From genset to thermal evaporator, according to layout. Thermal insulation.
2.9.5	Piping system, valves and instruments - cooling water	X		From thermal evaporator to new cooling tower, according to layout.
2.9.6	Piping system, valves and instruments - blowdown water system	X		From existing ammonia cooling towers to buffer tank and new thermal evaporator, according to layout. One spare pipe included.
2.9.7	Piping system, valves and instruments - distilled water	X		From new thermal evaporator to existing ammonia cooling towers, according to layout.
2.9.8	Piping system, valves and instruments - concentrated water	X		From thermal evaporator to drying beds, according to layout.
2.9.9	Blowdown water and Distilled water distribution pumps	X		Econo shall provide electrical connection to the blowdown water distribution pump within the ammonia cooling towers area.
2.9.10	Blowdown water buffer tank	X		1 x 12,000 Gal
2.9.11	Distilled water buffer tank	X		1 x 6,000 Gal
2.9.12	Drying channel	X		3 units
2.9.13	Auxiliary electric heater	X		1 unit
3 ENERGY STORAGE				
3.1	LV BESS 750 kW / 750 kWh	X		
4 ELECTRICAL SYSTEMS				
4.1 COMMUNICATIONS AND CONTROL				
4.1.1	Engine control panel	X		1 unit
4.1.2	Master control panel	X		1 unit
4.1.3	Communications rack	X		
4.1.4	Operator workstation	X		Remote Operation Design. Operation room to be located on Low Voltage & Control Room
4.1.5	Control system integration	X		PV, BESS, Diesel Engines and Gas Genset
4.1.6	SCADA	X		
4.1.7	Control system cables and transmission lines	X		
4.2 HIGH VOLTAGE SYSTEM				
4.2.1	Possible modifications to 38kV client's switchgear according to LUMA requirements		X	If required
4.2.2	Changes to LUMA distribution network and interconnection between Power Plant and LUMA control utilities (optical fiber line and equipment)		X	If required
4.2.3	Remotely operated control equipment LUMA		X	If required
4.3 MEDIUM VOLTAGE SYSTEM				
4.3.1	Step-up Transformer, 3,000kVA, 13.2kV/0.48kV	X		1 Unit.
4.3.2	New powerline between Step Up transformer and Paralleling Switchgear - 15kV	X	X	Use of existing canalization
4.3.3	New Cabinets at Paralleling SWG 15kV	X		1 Unit to be installed in the existing Paralleling Switchgear - 15kV.
4.3 LOW VOLTAGE SYSTEM				
4.3.1	Low Voltage Switchgear 480 V/ 4000A	X		According to SLD. Installation in container
4.3.2	Genset motor control center 480 V	X		
4.3.3	Low Voltage Transformer 480/208 V 50KVA	X		1 Unit
4.3.4	Auxiliary low voltage cabinet 220 V	X		
4.3.5	Lighting distribution board	X		
4.3.6	UPS, including batteries	X		
4.3.7	UPS distribution board	X		
4.3.8	LV transmission lines	X		Within Power Plant



ITEMS		SAMPOL CLIENT		NOTES
5 PV PLANT 1,785 kWp				
5.1 MAIN EQUIPMENT PHOTOVOLTAIC PLANT				
5.1.1	Monocrystalline solar panels of 620 Wp or similar	X		Model as a reference and subject to change as per final design to meet 1,705 kWp electrical power installed
5.1.2	Galvanized steel structure to accommodate solar panels	X		Steel support structure for coplanar installation with screws and steel anchors (Final design subject to modifications according to the constructive solution of the roof). It is considered that the roof can support the weight of the photovoltaic plant. Customer to confirm structural engineering is compatible with proposed design
5.1.3	Multi-String Inverter of 100 kVA	X		Power and number of inverters will be defined during detailed engineering to meet 1,500 kVA electrical power installed
5.2 DC INSTALLATION				
5.2.1	Electrical connection of solar panels	X		
5.2.2	Supply and installation, cable pulling and connection of string and inverters	X		
5.2.3	Rapid Shutdown devices	X		
5.2.4	Cable trays and tubes	X		
5.3 AC INSTALLATION				
5.3.1	General Low Voltage Switchgear 480 V to connect Photovoltaic	X		Located next to the PV plant
5.3.2	LV Cables from PV Plant LV SWG to New General LV SWG, conduits and cable trays	X	X	It si consider to use existing canalization. Cables included
5.3.3	Supply and installation, cable pulling and connection of equipment	X		
5.3.4	Cable trays and tubes	X		
5.4 MECHANICAL INSTALLATION				
5.4.1	Solar panels installation	X		
5.4.2	Structure installation	X		
5.4.3	Inverters installation	X		
6 CIVIL WORKS				
6.1	Access ways from the road to the Power Plant and LNG Satellite plant		X	
6.2	Demolitions and existing equipments dismantling		X	If required
6.3	Site clearing & Top soil removal		X	
6.4	Excavation, levelling, and filling (earthworks)	X		
6.5	Gravel		X	The removal of gravel from the POWER PLANT and LNG areas is contemplated for its subsequent reuse
6.6	Equipment foundations	X		
6.7	Stormwater & CES	X		plan during construction
6.8	Soundproofing measures	X		According to applicable regulations
6.9	Equipment access and maintenance structures	X		
6.10	Trenches, gutters, galleries, sewage pipes, or racks for electrical transmission lines, waterways, gas pipes and oil pipes	X		No conduits are contemplated for the photovoltaic plant or for the Transformer-Substation interconnection, it is considered the use of existing one. Pipe banks are only in the Motor - LV Container interconnections; LV Container - Transformer; LV Container - LNG Area; LV Containter - Brine drying system. Underground trenches for distilled water and blowdown water system from existing ammonia chiller plant cooling towers to brine drying system. Restoration of pavement considered for sections whose trenches traverse paved areas, according to layout. Aboveground pipe racks for the piping system within the brine drying plant area.
6.11	Warehouse & workshop		X	Space provided by client. To be conditioned, furnished and equiped by SAMPOL



	ITEMS	SAMPOL CLIENT		NOTES
7	ENGINEERING, WORKS MANAGEMENT, PERMITS AND TAXES			
7.1	Topographic assessment		X	If required
7.2	Geotechnical assessment		X	If required
7.3	Ambient Air & Water Quality Analysis		X	If required
7.4	Seismic & Wind Speed Survey		X	If required
7.5	Environmental assessment: noise, polluting emissions, effluents, ...		X	If required
7.6	Project & Engineering management for equipment supplied by Sampol	X		
7.7	Basic Engineering - Civil Works	X		
7.8	Basic Engineering - Mechanical	X		
7.9	Basic Engineering - Electrical	X		
7.10	Basic Engineering - Control	X		
7.11	Basic Engineering - Engine	X		
7.12	Detailed Engineering - Engine	X		
7.13	Detailed Engineering - Civil Works	X		
7.14	Detailed Engineering - Mechanical	X		
7.15	Detailed Engineering - Electrical	X		
7.16	Detailed Engineering - Control	X		
7.17	Health and Safety, and Environmental Procedures	X		
7.18	Quality Procedures	X		
7.19	Equipment certificates	X		
7.20	Construction permits, air permits and other permits	X	X	<ul style="list-style-type: none"> Sampol included all the permits for power plant All Government fees associated with permits to be paid directly by owner to PR government. Sampol will provide professional engineering drawing stamped by local professional engineer to ensure full compliance with local and federal applicable regulations for SAMPOL scope
7.21	Fondo del Seguro del Estado de Puerto Rico	X		
7.22	Sales, IVU and local taxes		X	
8	WORKS COMPLETION MANAGEMENT			
8.1	Anchoring Roof Installation works		X	Sampol to provide the installation / anchoring requirements. The anchoring solution needs to be developed by roof contractor. Econo and roof contractor will be responsible for the installation of anchoring system and will provide the warranty.
8.2	Panels installation	X		Sampol is only hold responsible if the crew is damaging the roof during the installation of the panels and or providing the wrong anchoring requirements.
8.3	Works' direction and supervision	X		
8.5	Appropriate area for the storage of equipment and material		X	
8.6	Appropriate area for works related to prefabrication and preparation of equipment		X	
8.7	Right of way		X	
8.8	Machinery and construction means	X		
8.9	Site offices and toilets		X	
8.10	Security Power Plant area		X	Covered by client security
8.11	Overnight surveillance of the plant plot		X	Covered by client security
8.12	Site electrical supply during construction		X	Utility by Owner, connection by Sampol
8.13	Site potable water supply during construction		X	Utility by Owner, connection by Sampol
8.14	ADSL or GPRS internet supply		X	
8.15	Construction fully comprehensive insurance	X		Not according to FM GLOBAL requirements if needed
8.16	Civil liability insurance	X		Not according to FM GLOBAL requirements if needed
8.17	Disposal of works waste during construction	X		
8.18	Disposal of preexisting waste on site		X	

HIGH EFFICIENCY HYBRID POWER PLANT ECONO DISTRIBUTION CENTER (CANÓVANAS, PUERTO RICO)

SCOPE OF SUPPLY (09/2024)



ITEMS		SAMPOL CLIENT		NOTES
9 TESTS AND COMMISSIONING				
9.1	PreCommissioning & Commissioning supervision	X		
9.2	Factory tests	X		
9.3	Travel costs for Owner's attendance to factory test		X	
9.4	On-site tests	X		
9.5	Oil fill for the engine and MV transformer	X		
9.6	Spare parts for commissioning	X		Only for main equipment provided by SAMPOL
9.7	Electricity required for tests		X	
9.8	Fuel required for tests		X	
9.9	Disposal of dangerous and non-dangerous wastes during tests	X		
9.10	Operators' training course	X		For equipment supplied by Sampol
10 LOGISTICS AND SHIPPING				
10.1	Shipping of equipment to site (land, sea and air)	X		
10.2	Port costs (loading, unloading, crantage, etc.)	X		
10.3	Management of customs clearance process	X		
10.4	Customs costs (customs dispatch, stamp charges...)	X		
10.5	Import duties		X	ECONO shall be solely responsible for the management of the customs clearance process for all Equipment. ECONO shall pay the sales and uses taxes ("SUT"), import duties, and any other taxes related to the importation or customs clearance ECONO shall serve as the Importer of Record of the Equipment and responsible for the import management of the Equipment.
10.6	Equipment unloading on site	X		



7 SCHEDULE

ECONO HYBRID POWER PLANT

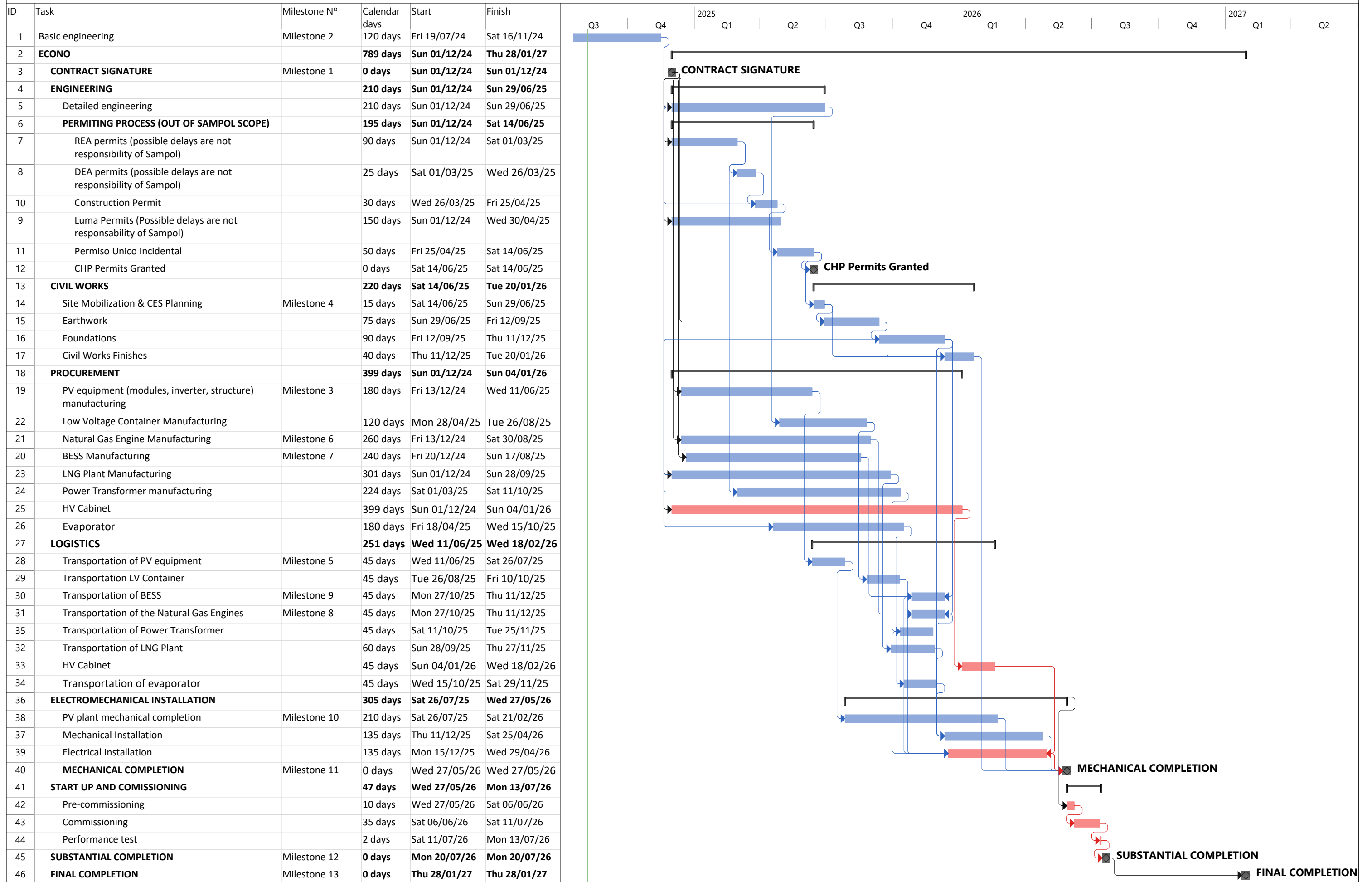

PRELIMINARY

  @ingSampol

 [linkedin.com/company/sampol](https://www.linkedin.com/company/sampol)



SAMPOL

CONTACT

Gremio Boneteros, 48, Palma de Mallorca | 07009 | Spain
www.sampol.com

Appendix 3

Airport Hazards Map

Econo Energy Project

Project ID: IPGM-00375

Address: State Road PR-3, Int. PR 9959, Km. 15.21 Bo.
Canovanillas, Canóvanas, PR. 00729

Coordinates: 18.373613° -65.906549°

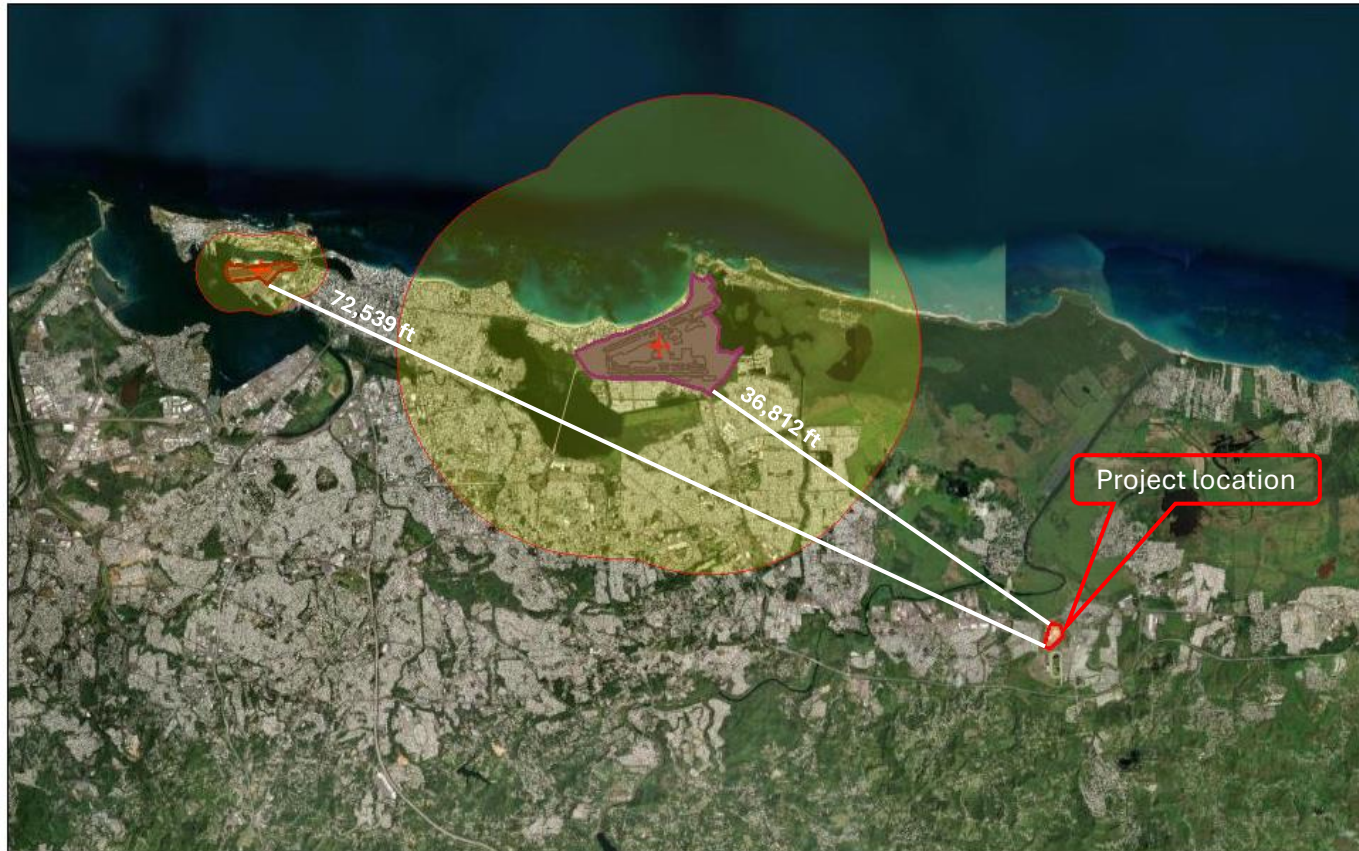

November 4, 2024

- Fernando Luis Ribas (2500 ft buffer)
- Luis Muñoz Marín (15000 ft buffer)
- Project Buffer

- Airport Points
- Airport Polygons
- Project 1

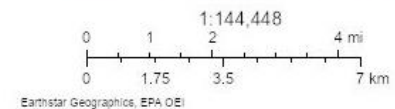

Appendix 4

Coastal Barrier Resources Map

Econo Energy Project

Project ID: IPGM-00375

Address: State Road PR-3, Int. PR 9959, Km. 15.21 Bo. Canovanillas, Canóvanas, PR. 00729

Coordinates: 18.373613° -65.906549°



U.S. Fish and Wildlife Service
Coastal Barrier Resources System

IPGM-00375



June 2, 2024

- CBRS Buffer Zone
- CBRS Units**
- Otherwise Protected Area
- System Unit

Spatial reference: unknwn

This map is for general reference only. The Coastal Barrier Resources System (CBRS) boundaries depicted on this map are representations of the controlling CBRS boundaries, which are shown on the official maps, accessible at <https://www.fws.gov/library/collection/official-coastal-barrier-resources-system-maps>. All CBRS related data should be used in accordance with the layer metadata found on the CBRS Mapper website.

The CBRS Buffer Zone represents the area immediately adjacent to the CBRS boundary where users are advised to contact the Service for an official determination (<https://www.fws.gov/service/coastal-barrier-resources-system-property-documentation>) as to whether the property or project site is located "in" or "out" of the CBRS.

CBRS Units normally extend seaward out to the 20- or 30-foot bathymetric contour (depending on the location of the unit). The true seaward

This page was produced by the CBRS Mapper

Appendix 5

Flood Insurance Rate Map (FIRM)

Econo Energy Project

Project ID: IPGM-00375

Address: State Road PR-3, Int. PR 9959, Km. 15.21 Bo. Canovanillas, Canóvanas, PR. 00729

Coordinates: 18.373613° -65.906549°

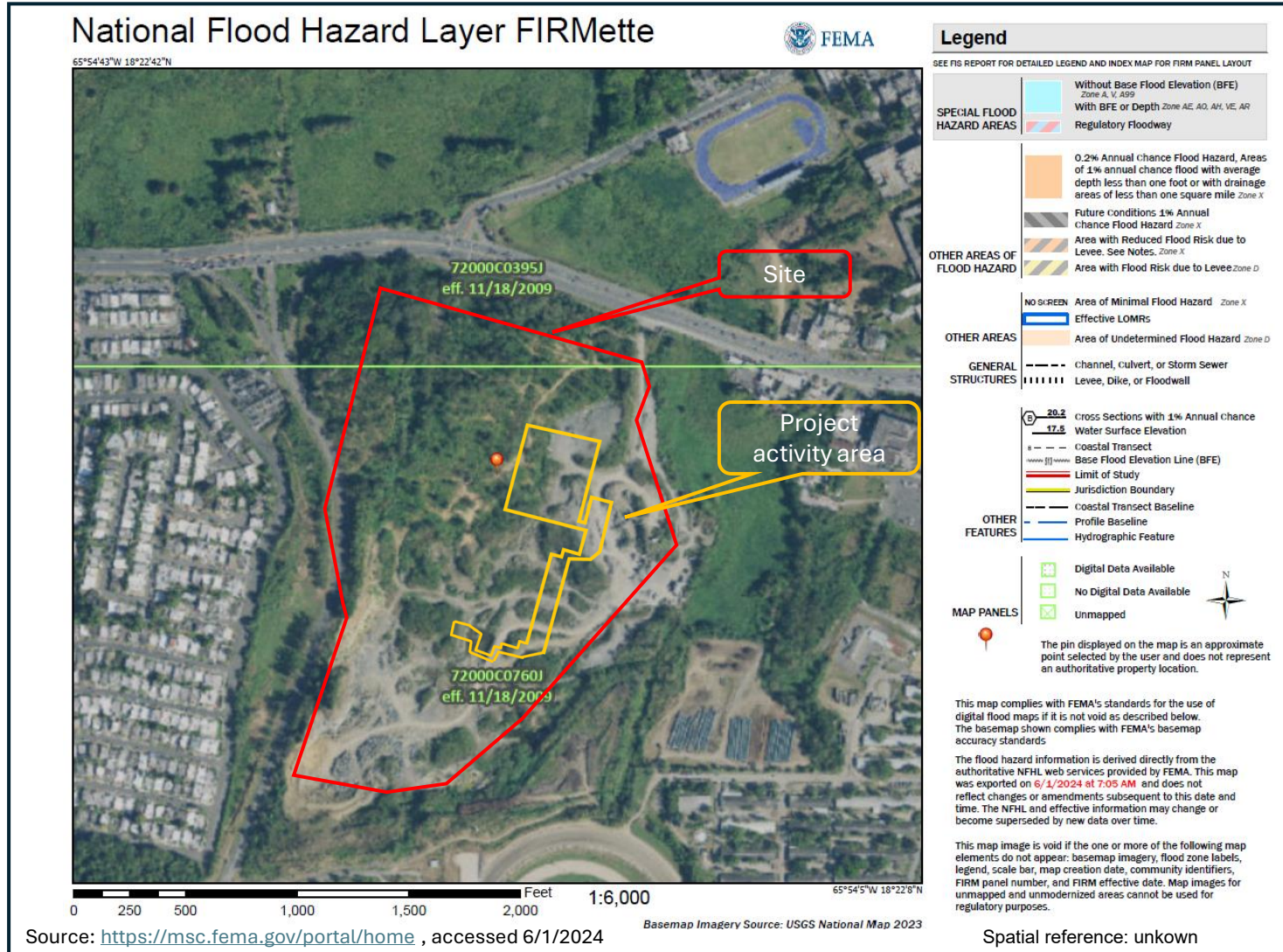
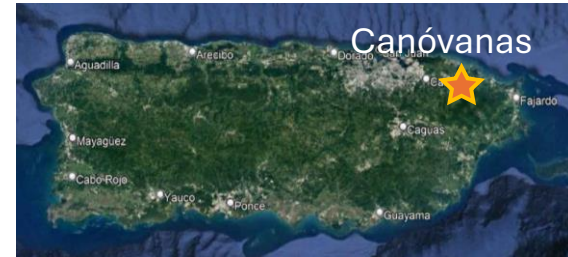

Appendix 6

Clean Air data

Appendix 6

Non-attainment Areas Map

Econo Energy Project

Project ID: IPGM-00375

Address: State Road PR-3, Int. PR 9959, Km. 15.21 Bo. Canovanillas, Canóvanas, PR. 00729

Coordinates: 18.373613° -65.906549°



Non-attainment Areas



August 28, 2024

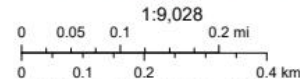

Maxar, U.S. EPA Office of Air and Radiation (OAR) - Office of Air Quality Planning and Standards (OAQPS)

Appendix 6a – EPA Green Book data

https://www.epa.gov/green-book/green-book-national-area-and-county-level-multi-pollutant-information

8/28/24, 12:47 AM

Puerto Rico Nonattainment/Maintenance Status for Each County by Year for All Criteria Pollutants | Green Book | US EPA



You are here: EPA Home > Green Book > >National Area and County-Level Multi-Pollutant Information >Puerto Rico Nonattainment/Maintenance Status for Each County by Year for All Criteria Pollutants

Puerto Rico Nonattainment/Maintenance Status for Each County by Year for All Criteria Pollutants

Data is current as of July 31, 2024

Listed by County, NAAQS, Area. The 8-hour Ozone (1997) standard was revoked on April 6, 2015 and the 1-hour Ozone (1979) standard was revoked on June 15, 2005.

* The 1997 Primary Annual PM-2.5 NAAQS (level of 15 µg/m³) is revoked in attainment and maintenance areas for that NAAQS. For additional information see the PM-2.5 NAAQS SIP Requirements Final Rule, effective October 24, 2016. (81 FR 58009)

Change the State:

Important Notes

[Download National Dataset: dbf](#) |
 [xls](#) |
 [Data dictionary \(PDF\)](#)

County	NAAQS	Area Name	Nonattainment in Year	Redesignation to Maintenance	Classification	Whole or/Part County	Population (2010)	State/County FIPS Codes
PUERTO RICO								
Arecibo Municipio	Lead (2008)	Arecibo, PR	1112131415161718192021222324	//		Part	32,185	72/013
Bayamon Municipio	Sulfur Dioxide (2010)	San Juan, PR	18192021222324	//		Part	22,921	72/021
Catano Municipio	Sulfur Dioxide (2010)	San Juan, PR	18192021222324	//		Whole	28,140	72/033
Guaynabo Municipio	PM-10 (1987)	Mun. of Guaynabo, PR	929394959697989900010203040506070809	02/11/2010	Moderate	Part	90,470	72/061
Guaynabo Municipio	Sulfur Dioxide (2010)	San Juan, PR	18192021222324	//		Part	23,802	72/061
Salinas Municipio	Sulfur Dioxide (2010)	Guayama-Salinas, PR	18192021222324	//		Part	23,401	72/123
San Juan Municipio	Sulfur Dioxide (2010)	San Juan, PR	18192021222324	//		Part	147,963	72/127
Toa Baja Municipio	Sulfur Dioxide (2010)	San Juan, PR	18192021222324	//		Part	52,441	72/137

Important Notes

Air Pollutant	Emission Factor mg/Nm ³
Nitrogen Oxides (NO _x)	<500 mg/Nm ³ @5%O ₂ -dry
Carbon Monoxide (CO)	<950 mg/Nm ³ @5%O ₂ -dry No guarantees without exhaust gas after treatment regarding CO emissions in general! Deposits in the combustion chamber may require a periodical decoking of the engine
Non Methane Hydrocarbons (NMHC)	NMHC -> Guaranteed values only on special release, a binding fuel gas analysis is required for pre-calculation. Maybe use of a special catalyst or CL.AIR is required
Methane (CH ₄)	Pending
Carbon Dioxide (CO ₂)	See below table
PM ₁₀ (filterable)	<p>Particle emissions / Dust: Under the pre-condition, that</p> <ul style="list-style-type: none"> • The combustion air and the fuel gas are free of any particles and contains no particle generating species, e.g. sulphur species, and • That the measurement will be performed according EN-13284-1 <p>The following standard values for PM₁₀/PM_{2.5}, Dust can be used For Natural Gas (MZ70 – MZ100) and cleaned Biogases, fulfilling the TA1000-0300 limits applicable for the usage of Formaldehyde catalysts in the exhaust, use:</p> <ul style="list-style-type: none"> • BR2, BR3, BR 4 → 5 mg/Nm³@5%O₂-dry <p>To perform particle measurements the exhaust piping needs some straight length for flow homogenization up-/downstream the sample port and the pipe must be w/o any flow influencing installations or inserts. The required space and the extra costs must be clarified with the customer</p>
SO ₂	No emissions guarantee, as the value is nearly exclusively dependent on the fuel gas. The lube oil has an insignificant influence



Printed by : Fernandez Martin, Alfonso

Printed on : 9/3/2024 3:09:14 PM

Product Program: PP2024

Valid until : 31.12.2024 00:00:00

Engine Type: J420 GS

BMEP [bar] : 16

Engine Version: J420 GS-B-805

RPM [1/min] : 1800

Fuel Gas : Natural Gas

	ppm-Dry	mg/Nm ³ @5%O ₂ -Dry	g/bhp-hr	g/kWh(mech)	g/GJ(th)	kg/hr	lbs/hr	tons/yr (short)
NO_x	172	500	1	1.4	157	2	4.4	19
CO	538	950	1.9	2.6	298	3.8	8.4	37

CO - Without After treatment system by INNIO Jenbacher, only as guiding value for information

Theoretical wet exhaust composition under assumption of 100 % fuel conversion

	vol.%	g/bhp-hr	g/kWh(mech)	g/GJ(th)	kg/hr	lbs/hr
CO₂	5.6	355	477	55020	700	1546
O₂	8.6					
N₂	73.7					
Ar	0.9					
H₂O	11.2					

A. Summary of Emission Estimates

Air Pollutant	Generator 1 Emissions (ton/yr)	Generator 2 Emissions (ton/yr)	Fire Control System Engine Emissions (ton/yr)	Generator J420 Emissions (ton/yr)	Total Emissions (ton/yr)	40 CFR 93.153(b) (2) following rates apply in maintenance areas: Emissions (ton/yr)
Particulate Matter (PM-10)	0.097	0.0967	0.103	0.1146	0.4110	100.0
Sulfur Oxides (SOx)	0.090	0.0904	0.096	0.0129	0.2902	100.0
Nitrogen Oxides (NOx)	1.375	1.3753	1.466	11.4613	15.6779	100.0
Carbon Monoxide (CO)	0.296	0.2963	0.316	21.7765	22.6848	100.0
Volatile organic compounds (VOC)	0.109	0.1091	0.116	2.5853	2.9200	100.0

New Natural Gas Genset

A. General Facility Information

Name: Almacen Supermercados Econo
Location: PR#3 int. PR 9959 Km 15.21
 Canovanas, Puerto Rico

B: Emission Source Information

Unit Type: Taylor Power Systems Emergency Generator 1
Mfg: Taylor Power Systems
Power: 165 HP
Fuel: Diesel
Fuel Rate: 9.1 gal/hr
Sulfur Content (S): 0.0015 Weight Percent (maximum)
Heating Value: 0.137 MM BTU/gallon
Fuel Density: 7.3 lB/gal

C: Emission Factors

Table 3.3-1 Emission Factors for Uncontrolled Gasoline and Diesel Industrial Engines
 Gasoline and Diesel Industrial Engines (Up to 600 HP for Diesel Engines)
 Page 3.3-6, Compilation of Air Pollutant Emission Factors (AP-42)
 October, 1996

Air Pollutant	Emission Factor (lb/MM BTU)
Particulate Matter (PM-10)	0.31
Sulfur Oxides (SOx)	0.29
Nitrogen Oxides (NOx)	4.41
Carbon Monoxide (CO)	0.95
Total Organic Carbons (Exhaust)	0.35

Operating Time: **500** hrs/year

D: Emission Estimates

Particulate Matter (PM-10)						
500	hr	9.1	gal	0.31	lb	0.137
	year		hr		MM BTU	gal
				=	0.0967 ton/year	
Sulfur Oxides (SOx)						
500	hr	9.1	gal	0.29	lb	0.137
	year		hr		MM BTU	gal
				=	0.0904 ton/year	
Nitrogen Oxides (NOx)						
500	hr	9.1	gal	4.41	lb	0.137
	year		hr		MM BTU	gal
				=	1.3753 ton/year	
Carbon Monoxide (CO)						
500	hr	9.1	gal	0.95	lb	0.137
	year		hr		MM BTU	gal
				=	0.2963 ton/year	
Total Organic Carbons (Exhaust)						
500	hr	9.1	gal	0.35	lb	0.137
	year		hr		MM BTU	gal
				=	0.1091 ton/year	

Table 3.3-2 Speciated Organic Compound Emission Factors for Uncontrolled Diesel Engines

Gasoline and Diesel Industrial Engines
 Page 3.3-7, Compilation of Air Pollutant Emission Factors (AP-42)
 October, 1996

Air Pollutant	Emission Factor (lb/MM BTU)
Benzene*	9.33E-04
Toluene*	4.09E-04
Xylenes*	2.85E-04
Propylene	2.58E-03
1,3-Butadiene*	3.91E-05
Formaldehyde*	1.18E-03
Acetaldehyde*	7.67E-04
Acrolein*	9.25E-05
Naphthalene*	8.48E-05
Total PAH	1.68E-04

*HAP listed in the Clean Air Act.

E: Emission Estimates for HAPs

Benzene									
500	hr	9.1	gal	0.137	MM BTU	9.33E-04	lb Benzene	1	ton
	year		hr		gal		MM BTU	2,000	lb
							=	2.91E-04 ton/year	
Toluene									
500	hr	9.1	gal	0.137	MM BTU	4.09E-04	lb Toluene	1	ton
	year		hr		gal		MM BTU	2,000	lb
							=	1.28E-04 ton/year	
Xylenes									
500	hr	9.1	gal	0.137	MM BTU	2.85E-04	lb Xylenes	1	ton
	year		hr		gal		MM BTU	2,000	lb
							=	8.89E-05 ton/year	
Propylene									
500	hr	9.1	gal	0.137	MM BTU	2.58E-03	lb Propylene	1	ton
	year		hr		gal		MM BTU	2,000	lb
							=	8.05E-04 ton/year	
Formaldehyde									
500	hr	9.1	gal	0.137	MM BTU	1.18E-03	lb Formaldehyde	1	ton
	year		hr		gal		MM BTU	2,000	lb
							=	3.68E-04 ton/year	
Acetaldehyde									
500	hr	9.1	gal	0.137	MM BTU	7.67E-04	lb Acetaldehyde	1	ton
	year		hr		gal		MM BTU	2,000	lb
							=	2.39E-04 ton/year	
Acrolein									
500	hr	9.1	gal	0.137	MM BTU	9.25E-05	lb Acrolein	1	ton
	year		hr		gal		MM BTU	2,000	lb
							=	2.88E-05 ton/year	
Naphthalene									
500	hr	9.1	gal	0.137	MM BTU	8.48E-05	lb Naphthalene	1	ton
	year		hr		gal		MM BTU	2,000	lb
							=	2.64E-05 ton/year	
TOTAL PAH									
500	hr	9.1	gal	0.137	MM BTU	1.68E-04	lb Total PAH	1	ton
	year		hr		gal		MM BTU	2,000	lb

= 5.24E-05 ton/year

CO₂ Equivalent Calculations

40 CFR Part 98- Mandatory Greenhouse Gas Reporting
Federal Register / Vol 74, No. 209 /Friday, October 30, 2009

FOR CO₂

Fuel type:	Distillate Fuel Oil No. 2		Source
Default high heat value (HHV)		0.138 mmBtu/gal	Table C-1
Default CO ₂ emission factor (EF)		73.96 Kg CO ₂ /mmBtu	Table C-1

FOR CH₄ and N₂O

Fuel type:	Petroleum (All fuel types in Table C-1)	(Diesel, Propane)	Carbon Dioxide (CO ₂)
Default CH ₄ emission factor (EF)		0.003 Kg CH ₄ /mmBTU	Table C-2
Default N ₂ O emission factor (EF)		0.0006 kg N ₂ O/mmBTU	Table C-2
			Methane (CH ₄)
			Nitric Oxide (N ₂ O)

Equation: $= 1 \times 10^{-3} * \text{Fuel} * \text{HHV} * \text{EF}$ (Eq. C-8)

Carbon Dioxide (CO₂)

$$\frac{0.0010}{1} \times \frac{4,550 \text{ gal}}{\text{yr}} \times \frac{0.1380 \text{ MMBTU}}{\text{gal}} \times \frac{73.96 \text{ Kg N}_2\text{O}}{\text{MM BTU}} = 46.4394840 \text{ ton/year}$$

Methane (CH₄)

$$\frac{0.0010}{1} \times \frac{4,550 \text{ gal}}{\text{yr}} \times \frac{0.1380 \text{ MMBTU}}{\text{gal}} \times \frac{0.003 \text{ Kg N}_2\text{O}}{\text{MM BTU}} = 0.0019 \text{ ton/year}$$

Nitric Oxide (N₂O)

$$\frac{0.0010}{1} \times \frac{4,550 \text{ gal}}{\text{yr}} \times \frac{0.1380 \text{ MMBTU}}{\text{gal}} \times \frac{0.0006 \text{ Kg N}_2\text{O}}{\text{MM BTU}} = 0.0004 \text{ ton/year}$$

$\text{CO}_{2e} = \sum \text{GHGi} \times \text{GWPI}$ (Eq. A-1)

CO ₂ Equivalent Calculations	Ton/yr	GWP1	CO ₂ e
Carbon Dioxide (CO ₂)	46.44	1.00	46.44
Methane (CH ₄)	0.00	25.00	0.05
Nitric Oxide (N ₂ O)	0.00038	310.00	0.12
Total			46.60

F: Summary of Emission Estimates

Air Pollutant	Emissions (tons/year)
Particulate Matter (PM-10)	0.0967
Sulfur Oxides (SO _x)	0.0904
Nitrogen Oxides (NO _x)	1.3753
Carbon Monoxide (CO)	0.2963
TOC (Exhaust)	0.1091
HAPs	0.0020
CO ₂ e	46.60337

A. General Facility Information

Name: Almacen Supermercados Econo
Location: PR#3 int. PR 9959 Km 15.21
 Canovanas, Puerto Rico

B: Emission Source Information

Unit Type: Taylor Power Systems Emergency Generator 2
Mfg: Taylor Power Systems
Power: 165 HP
Fuel: Diesel
Fuel Rate: 9.1 gal/hr
Sulfur Content (S): 0.0015 Weight Percent (maximum)
Heating Value: 0.137 MM BTU/gallon
Fuel Density: 7.3 lLb/gal

C: Emission Factors

Table 3.3-1 Emission Factors for Uncontrolled Gasoline and Diesel Industrial Engines
 Gasoline and Diesel Industrial Engines (Up to 600 HP for Diesel Engines)
 Page 3.3-6, Compilation of Air Pollutant Emission Factors (AP-42)
 October, 1996

Air Pollutant	Emission Factor (lb/MM BTU)
Particulate Matter (PM-10)	0.31
Sulfur Oxides (SOx)	0.29
Nitrogen Oxides (NOx)	4.41
Carbon Monoxide (CO)	0.95
Total Organic Carbons (Exhaust)	0.35

Operating Time: **500** hrs/year

D: Emission Estimates

Particulate Matter (PM-10)						
500	hr	9.1	gal	0.31	lb	0.137
	year		hr		MM BTU	gal
				=		2,000
						0.0967 ton/year
Sulfur Oxides (SOx)						
500	hr	9.1	gal	0.29	lb	0.137
	year		hr		MM BTU	gal
				=		2,000
						0.0904 ton/year
Nitrogen Oxides (NOx)						
500	hr	9.1	gal	4.41	lb	0.137
	year		hr		MM BTU	gal
				=		2,000
						1.3753 ton/year
Carbon Monoxide (CO)						
500	hr	9.1	gal	0.95	lb	0.137
	year		hr		MM BTU	gal
				=		2,000
						0.2963 ton/year
Total Organic Carbons (Exhaust)						
500	hr	9.1	gal	0.35	lb	0.137
	year		hr		MM BTU	gal
				=		2,000
						0.1091 ton/year

Table 3.3-2 Speciated Organic Compound Emission Factors for Uncontrolled Diesel Engines

Gasoline and Diesel Industrial Engines
 Page 3.3-7, Compilation of Air Pollutant Emission Factors (AP-42)
 October, 1996

Air Pollutant	Emission Factor (lb/MM BTU)
Benzene*	9.33E-04
Toluene*	4.09E-04
Xylenes*	2.85E-04
Propylene	2.58E-03
1,3-Butadiene*	3.91E-05
Formaldehyde*	1.18E-03
Acetaldehyde*	7.67E-04
Acrolein*	9.25E-05
Naphthalene*	8.48E-05
Total PAH	1.68E-04

*HAP listed in the Clean Air Act.

E: Emission Estimates for HAPs

Benzene									
500	hr	9.1	gal	0.137	MM BTU	9.33E-04	lb Benzene	1	ton
	year		hr		gal		MM BTU	2,000	lb
							=	2.91E-04 ton/year	
Toluene									
500	hr	9.1	gal	0.137	MM BTU	4.09E-04	lb Toluene	1	ton
	year		hr		gal		MM BTU	2,000	lb
							=	1.28E-04 ton/year	
Xylenes									
500	hr	9.1	gal	0.137	MM BTU	2.85E-04	lb Xylenes	1	ton
	year		hr		gal		MM BTU	2,000	lb
							=	8.89E-05 ton/year	
Propylene									
500	hr	9.1	gal	0.137	MM BTU	2.58E-03	lb Propylene	1	ton
	year		hr		gal		MM BTU	2,000	lb
							=	8.05E-04 ton/year	
Formaldehyde									
500	hr	9.1	gal	0.137	MM BTU	1.18E-03	lb Formaldehyde	1	ton
	year		hr		gal		MM BTU	2,000	lb
							=	3.68E-04 ton/year	
Acetaldehyde									
500	hr	9.1	gal	0.137	MM BTU	7.67E-04	lb Acetaldehyde	1	ton
	year		hr		gal		MM BTU	2,000	lb
							=	2.39E-04 ton/year	
Acrolein									
500	hr	9.1	gal	0.137	MM BTU	9.25E-05	lb Acrolein	1	ton
	year		hr		gal		MM BTU	2,000	lb
							=	2.88E-05 ton/year	
Naphthalene									
500	hr	9.1	gal	0.137	MM BTU	8.48E-05	lb Naphthalene	1	ton
	year		hr		gal		MM BTU	2,000	lb
							=	2.64E-05 ton/year	
TOTAL PAH									
500	hr	9.1	gal	0.137	MM BTU	1.68E-04	lb Total PAH	1	ton
	year		hr		gal		MM BTU	2,000	lb

= 5.24E-05 ton/year

CO₂ Equivalent Calculations

40 CFR Part 98- Mandatory Greenhouse Gas Reporting
Federal Register / Vol 74, No. 209 /Friday, October 30, 2009

FOR CO₂

Fuel type:	Distillate Fuel Oil No. 2		Source
Default high heat value (HHV)		0.138 mmBtu/gal	Table C-1
Default CO ₂ emission factor (EF)		73.96 Kg CO ₂ /mmBtu	Table C-1

FOR CH₄ and N₂O

Fuel type:	Petroleum (All fuel types in Table C-1)	(Diesel, Propane)	Carbon Dioxide (CO ₂)
Default CH ₄ emission factor (EF)		0.003 Kg CH ₄ /mmBTU	Table C-2
Default N ₂ O emission factor (EF)		0.0006 kg N ₂ O/mmBTU	Table C-2
			Methane (CH ₄)
			Nitric Oxide (N ₂ O)

Equation: $= 1 \times 10^{-3} * \text{Fuel} * \text{HHV} * \text{EF}$ (Eq. C-8)

Carbon Dioxide (CO₂)

$$\frac{0.0010}{1} \times \frac{4,550 \text{ gal}}{\text{yr}} \times \frac{0.1380 \text{ MMBTU}}{\text{gal}} \times \frac{73.96 \text{ Kg N}_2\text{O}}{\text{MM BTU}} = 46.4394840 \text{ ton/year}$$

Methane (CH₄)

$$\frac{0.0010}{1} \times \frac{4,550 \text{ gal}}{\text{yr}} \times \frac{0.1380 \text{ MMBTU}}{\text{gal}} \times \frac{0.003 \text{ Kg N}_2\text{O}}{\text{MM BTU}} = 0.0019 \text{ ton/year}$$

Nitric Oxide (N₂O)

$$\frac{0.0010}{1} \times \frac{4,550 \text{ gal}}{\text{yr}} \times \frac{0.1380 \text{ MMBTU}}{\text{gal}} \times \frac{0.0006 \text{ Kg N}_2\text{O}}{\text{MM BTU}} = 0.0004 \text{ ton/year}$$

$\text{CO}_{2e} = \sum \text{GHGi} \times \text{GWPI}$ (Eq. A-1)

CO ₂ Equivalent Calculations	Ton/yr	GWP1	CO ₂ e
Carbon Dioxide (CO ₂)	46.44	1.00	46.44
Methane (CH ₄)	0.00	25.00	0.05
Nitric Oxide (N ₂ O)	0.00038	310.00	0.12
Total			46.60

F: Summary of Emission Estimates

Air Pollutant	Emissions (tons/year)
Particulate Matter (PM-10)	0.0967
Sulfur Oxides (SO _x)	0.0904
Nitrogen Oxides (NO _x)	1.3753
Carbon Monoxide (CO)	0.2963
TOC (Exhaust)	0.1091
HAPs	0.0020
CO ₂ e	46.60337

A. General Facility Information

Name: Almacén y Centro de Distribución Supermercados Econo
Location: PR#3 int. PR 9959 Km 15.21
 Canovanas, Puerto Rico

B. Emission Source Information

Unit Type: Fire Control System Engine
Mfg: Taylor Power Systems
Power: 282 HP
Fuel: Diesel
Fuel Rate: 9.7 gal/hr
Sulfur Content (S): 0.0015 Weight Percent (maximum)
Heating Value: 0.137 MM BTU/gallon
Fuel Density: 7.3 lLb/gal

C. Emission Factors

Table 3.3-1 Emission Factors for Uncontrolled Gasoline and Diesel Industrial Engines
 Gasoline and Diesel Industrial Engines (Up to 600 HP for Diesel Engines)
 Page 3.3-6, Compilation of Air Pollutant Emission Factors (AP-42)
 October, 1996

Air Pollutant	Emission Factor (lb/MM BTU)
Particulate Matter (PM-10)	0.31
Sulfur Oxides (SOx)	0.29
Nitrogen Oxides (NOx)	4.41
Carbon Monoxide (CO)	0.95
Total Organic Carbons (Exhaust)	0.35

Operating Time: **500** hrs/year

D. Emission Estimates

Particulate Matter (PM-10)						
500	hr	9.7	gal	0.31	lb	0.137
	year		hr		MM BTU	gal
				=		0.1030 ton/year
Sulfur Oxides (SOx)						
500	hr	9.7	gal	0.29	lb	0.137
	year		hr		MM BTU	gal
				=		0.0964 ton/year
Nitrogen Oxides (NOx)						
500	hr	9.7	gal	4.41	lb	0.137
	year		hr		MM BTU	gal
				=		1.4660 ton/year
Carbon Monoxide (CO)						
500	hr	9.7	gal	0.95	lb	0.137
	year		hr		MM BTU	gal
				=		0.3158 ton/year
Total Organic Carbons (Exhaust)						
500	hr	9.7	gal	0.35	lb	0.137
	year		hr		MM BTU	gal
				=		0.1163 ton/year

Table 3.3-2 Speciated Organic Compound Emission Factors for Uncontrolled Diesel Engines

Gasoline and Diesel Industrial Engines
 Page 3.3-7, Compilation of Air Pollutant Emission Factors (AP-42)
 October, 1996

Air Pollutant	Emission Factor (lb/MM BTU)
Benzene*	9.33E-04
Toluene*	4.09E-04
Xylenes*	2.85E-04
Propylene	2.58E-03
1,3-Butadiene*	3.91E-05
Formaldehyde*	1.18E-03
Acetaldehyde*	7.67E-04
Acrolein*	9.25E-05
Naphthalene*	8.48E-05
Total PAH	1.68E-04

*HAP listed in the Clean Air Act.

E: Emission Estimates for HAPs

Benzene									
500	hr	9.7	gal	0.137	MM BTU	9.33E-04	lb Benzene	1	ton
	year		hr		gal		MM BTU	2,000	lb
							=	3.10E-04 ton/year	
Toluene									
500	hr	9.7	gal	0.137	MM BTU	4.09E-04	lb Toluene	1	ton
	year		hr		gal		MM BTU	2,000	lb
							=	1.36E-04 ton/year	
Xylenes									
500	hr	9.7	gal	0.137	MM BTU	2.85E-04	lb Xylenes	1	ton
	year		hr		gal		MM BTU	2,000	lb
							=	9.47E-05 ton/year	
Propylene									
500	hr	9.7	gal	0.137	MM BTU	2.58E-03	lb Propylene	1	ton
	year		hr		gal		MM BTU	2,000	lb
							=	8.58E-04 ton/year	
Formaldehyde									
500	hr	9.7	gal	0.137	MM BTU	1.18E-03	lb Formaldehyde	1	ton
	year		hr		gal		MM BTU	2,000	lb
							=	3.92E-04 ton/year	
Acetaldehyde									
500	hr	9.7	gal	0.137	MM BTU	7.67E-04	lb Acetaldehyde	1	ton
	year		hr		gal		MM BTU	2,000	lb
							=	2.55E-04 ton/year	
Acrolein									
500	hr	9.7	gal	0.137	MM BTU	9.25E-05	lb Acrolein	1	ton
	year		hr		gal		MM BTU	2,000	lb
							=	3.07E-05 ton/year	
Naphthalene									
500	hr	9.7	gal	0.137	MM BTU	8.48E-05	lb Naphthalene	1	ton
	year		hr		gal		MM BTU	2,000	lb
							=	2.82E-05 ton/year	
TOTAL PAH									
500	hr	9.7	gal	0.137	MM BTU	1.68E-04	lb Total PAH	1	ton
	year		hr		gal		MM BTU	2,000	lb

= 5.58E-05 ton/year

CO₂ Equivalent Calculations

40 CFR Part 98- Mandatory Greenhouse Gas Reporting
Federal Register / Vol 74, No. 209 /Friday, October 30, 2009

FOR CO₂

Fuel type:	Distillate Fuel Oil No. 2		Source
Default high heat value (HHV)		0.138 mmBtu/gal	Table C-1
Default CO ₂ emission factor (EF)		73.96 Kg CO ₂ /mmBtu	Table C-1

FOR CH₄ and N₂O

Fuel type:	Petroleum (All fuel types in Table C-1)	(Diesel, Propane)	Carbon Dioxide (CO ₂)
Default CH ₄ emission factor (EF)		0.003 Kg CH ₄ /mmBTU	Table C-2
Default N ₂ O emission factor (EF)		0.0006 kg N ₂ O/mmBTU	Table C-2
			Methane (CH ₄)
			Nitric Oxide (N ₂ O)

Equation: $= 1 \times 10^{-3} * \text{Fuel} * \text{HHV} * \text{EF}$ (Eq. C-8)

Carbon Dioxide (CO₂)

$$\frac{0.0010}{1} \times \frac{4,850 \text{ gal}}{\text{yr}} \times \frac{0.1380 \text{ MMBTU}}{\text{gal}} \times \frac{73.96 \text{ Kg N}_2\text{O}}{\text{MM BTU}} = 49.5014280 \text{ ton/year}$$

Methane (CH₄)

$$\frac{0.0010}{1} \times \frac{4,850 \text{ gal}}{\text{yr}} \times \frac{0.1380 \text{ MMBTU}}{\text{gal}} \times \frac{0.003 \text{ Kg N}_2\text{O}}{\text{MM BTU}} = 0.0020 \text{ ton/year}$$

Nitric Oxide (N₂O)

$$\frac{0.0010}{1} \times \frac{4,850 \text{ gal}}{\text{yr}} \times \frac{0.1380 \text{ MMBTU}}{\text{gal}} \times \frac{0.0006 \text{ Kg N}_2\text{O}}{\text{MM BTU}} = 0.0004 \text{ ton/year}$$

$\text{CO}_{2e} = \sum \text{GHGI} \times \text{GWPI}$ (Eq. A-1)

CO ₂ Equivalent Calculations	Ton/yr	GWP1	CO ₂ e
Carbon Dioxide (CO ₂)	49.50	1.00	49.50
Methane (CH ₄)	0.00	25.00	0.05
Nitric Oxide (N ₂ O)	0.00040	310.00	0.12
Total			49.68

F: Summary of Emission Estimates

Air Pollutant	Emissions (tons/year)
Particulate Matter (PM-10)	0.1030
Sulfur Oxides (SO _x)	0.0964
Nitrogen Oxides (NO _x)	1.4660
Carbon Monoxide (CO)	0.3158
VOC (Exhaust)	0.1163
HAPs	0.0022
CO ₂ e	49.67612

year	hr	MM BTU	2000	lb	Emissions =
Methane (CH4)					
8,760	hr	5.00	MM BTU	1.25E+00	lb CH4
	year		hr	MM BTU	2000
					1 ton
					2000 lb
Emissions = 2.59 ton/year					
Sulfur Oxides (SOx)					
8,760	hr	5.00	MM BTU	5.88E-04	lb SOx
	year		hr	MM BTU	2000
					1 ton
					2000 lb
Emissions = 27.39 ton/year					
CO₂ Equivalent Calculations					
Source: 40 CFR Part 98- Mandatory Greenhouse Gas Reporting					
Federal Register / Vol 74, No. 209 /Friday, October 30, 2009					
FOR CH ₄ and NO _x					
Fuel type: Natural Gas					
Default N ₂ O emission factor (EF) 0.0001 kg N2O/mml Table C-2					
Equation: N ₂ O = 1x10 ⁻³ * Fuel * HHV * EF (Eq. C-8)					
Nitric Oxide (N2O)					
0.0010		42,584,328	ft3	0.0010	MMBTU
			yr		ft3
				0.0001	Kg N2O
				1	MM BTU
Emissions = 0.013 ton/year					

Source: 40 CFR Part 98- Mandatory Greenhouse Gas Reporting
Federal Register / Vol 74, No. 209 /Friday, October 30, 2009

FOR CH₄ and NO_x

Fuel type: Natural Gas

Default N₂O emission factor (EF) 0.0001 kg N2O/mml Table C-2

Equation: N₂O = 1x10⁻³ * Fuel * HHV * EF (Eq. C-8)

Nitric Oxide (N2O)

0.0010	42,584,328	ft3	0.0010	MMBTU	0.0001	Kg N2O
		yr		ft3	1	MM BTU

= 0.0044 ton/year

CO_{2e} = Σ GHGi x GWPI (Eq. A-1)

CO2 Equivalent Calculations	Ton/yr	GWP1	CO2e
Carbon Dioxide (CO2)	2410.06	1.00	2,410.06
Methane (CH4)	27.39	25.00	684.68
Nitric Oxide (N2O)	0.00438	265.00	1.16
CO2e			3,095.90

Reference: AP 42, Fifth Edition

Compilation of Air Pollutant Emission Factors
Volume 1: Stationary Point and Area Sources

Description: Emission Factors for Speciated Organic Compounds from
Natural Gas Combustion

Table 1.4-3 Emission Factors for Speciated Organic Compounds from
Natural Gas Combustion

Air Pollutant	Emission Factor (lb/MMBtu)	VOC (Ton/yr)	HAP (Ton/yr)
1,1,2,2-Tetrachloroethane	4.00E-05	0.00088	0.00088
1,1,2-Trichloroethane	3.18E-05	0.00070	0.00070
1,1-Dichloroethane	2.36E-05	0.00052	
1,2,3-Trimethylbenzene	2.30E-05	0.00050	
1,2,4-Trimethylbenzene	1.43E-05	0.00031	
1,2-Dichloroethane	2.36E-05	0.00052	
1,2-Dichloropropane	2.69E-05	0.00059	
1,3,5-Trimethylbenzene	3.38E-05	0.00074	
1,3-Butadiene	2.67E-04	0.00585	0.00585
1,3-Dichloropropene	2.64E-05	0.00058	0.00058
2-Methylnaphthalene	3.32E-05	0.00073	0.00073
2,2,4-Trimethylpentane	2.50E-05	0.00055	0.00055
Acenaphthene	1.25E-06	0.00003	0.00003
Acenaphthylene	5.53E-05	0.00121	0.00121
Acetaldehyde	8.36E-03	0.18316	0.18316
Acrolein	5.14E-03	0.11262	0.11262
Benzene	4.40E-04	0.00964	0.00964
Benzo(b)fluoranthene	1.66E-07	0.00000	0.00000
Benzo(e)pyrene	4.15E-07	0.00001	0.00001
Benzo(g,h,i)perylene	4.14E-07	0.00001	0.00001
Biphenyl	2.12E-04	0.00464	0.00464
Butane	5.41E-04	0.01185	
Butyl/Isobutylaldehyde	1.01E-04	0.00221	
Carbon Tetrachloride	3.67E-05	0.00080	0.00080
Chlorobenzene	3.04E-05	0.00067	0.00067
Chloroethane	1.87E-06	0.00004	
Chloroform	2.85E-05	0.00062	0.00062
Chrysene	6.93E-07	0.00002	0.00002
Cyclopentane	2.27E-04	0.00497	
Ethane	1.05E-01	2.30051	
Ethylbenzene	3.97E-05	0.00087	0.00087

Ethylene Dibromide	4.43E-05	0.00097	0.00097
Fluoranthene	1.11E-06	0.00002	0.00002
Fluorenek	5.67E-06	0.00012	0.00012
Formaldehyde*	5.28E-02	1.15683	1.15683
Methanol	2.50E-03	0.05477	0.05477
Methylcyclohexane	1.23E-03	0.02695	
Methylene Chloride	2.00E-05	0.00044	0.00044
n-Hexane	1.11E-03	0.02432	0.02432
n-Nonane	1.10E-04	0.00241	
n-Octane	3.51E-04	0.00769	
n-Pentane	2.60E-03	0.05697	
Naphthalene	7.44E-05	0.00163	0.00163
PAH	2.69E-05	0.00059	0.00059
Phenanthrene	1.04E-05	0.00023	0.00023
Phenol	2.40E-05	0.00053	0.00053
Propane	4.19E-02	0.91801	
Pyrene	1.36E-06	0.00003	0.00003
Styrene	2.36E-05	0.00052	0.00052
Tetrachloroethane	2.48E-06	0.00005	0.00005
Toluene	4.08E-04	0.00894	0.00894
Vinyl Chloridek	1.49E-05	0.00033	0.00033
Xylene	1.84E-04	0.00403	0.00403
Total		4.91273	1.57793

E. Summary of Emission Estimates

Air Pollutant	Emissions (ton/yr)
Particulate Matter (PM-10)	0.1146
Sulfur Oxides (SOx)	0.013
Nitrogen Oxides (NOx)	11.46
Carbon Monoxide (CO)	21.78
Non Methane Hydrocarbons (NMHC)	4.89
Volatile organic compounds (VOC)	2.59
Methane (CH4)	27.39
Carbon Dioxide (CO2)	2,410.06
HAPs	1.58
Formaldehyde*	1.16
CO2e	3,095.90

Appendix 7

Coastal Zone Boundary Map

Econo Energy Project

Project ID: IPGM-00375

Address: State Road PR-3, Int. PR 9959, Km. 15.21 Bo. Canovanillas, Canóvanas, PR. 00729

Coordinates: 18.373613° -65.906549°

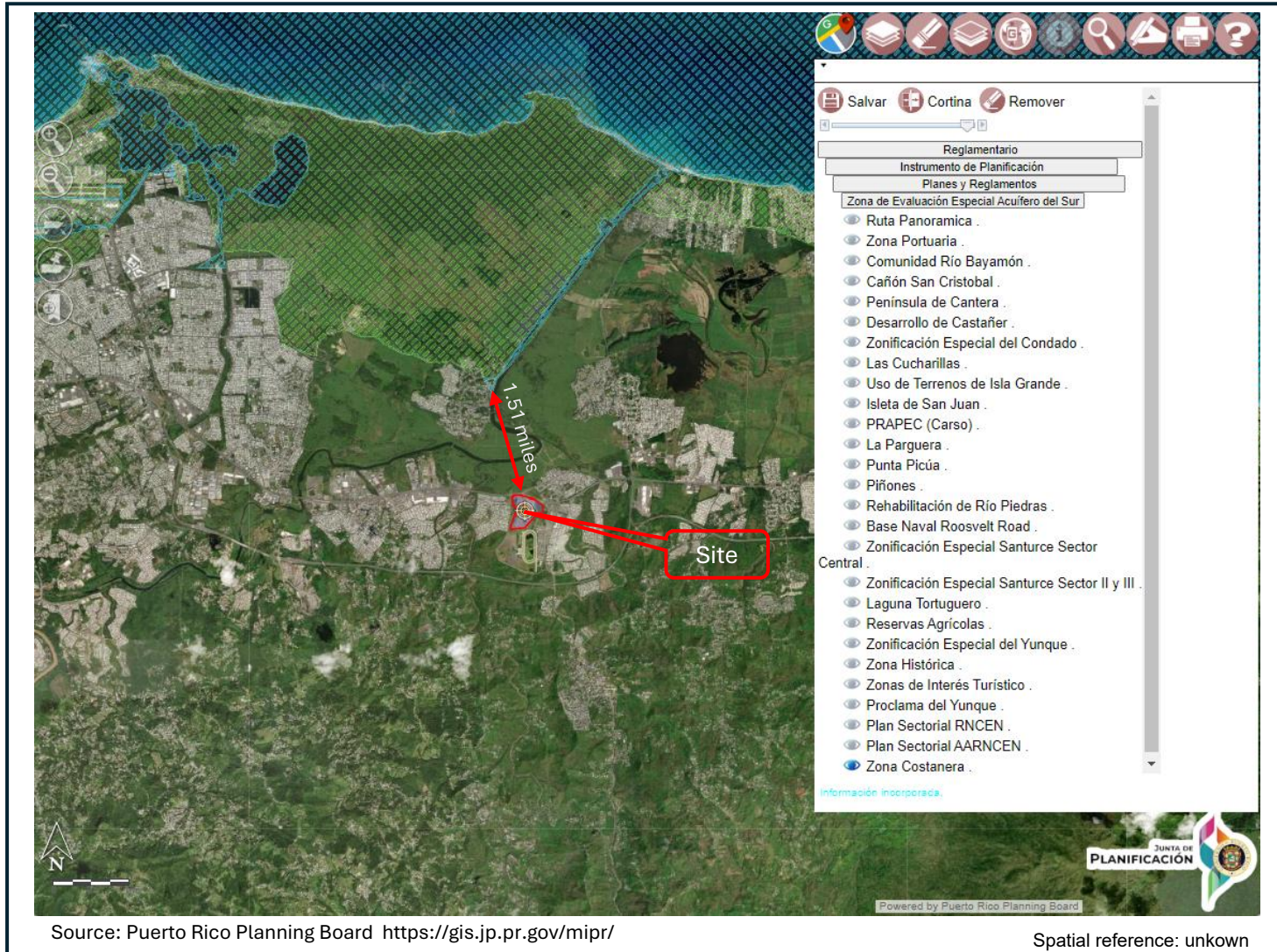

Source: Puerto Rico Planning Board <https://gis.jp.pr.gov/mipr/>

Spatial reference: unknown

Appendix 8

Contamination and Toxic Substances

Appendix 8a

Historical imagery – Google Earth Pro

Econo Energy Project

Project ID: IPGM-00375

Address: State Road PR-3, Int. PR 9959, Km. 15.21 Bo.

Canovanillas, Canóvanas, PR. 00729

Coordinates: 18.373613° -65.906549°

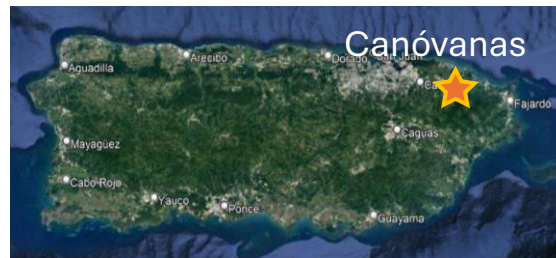

Imagery
Date:
4/28/2018



Source: Google Earth

Spatial reference: unknwn

Appendix 8b

Historical imagery – Google Earth Pro

Econo Energy Project

Project ID: IPGM-00375

Address: State Road PR-3, Int. PR 9959, Km. 15.21 Bo.

Canovanillas, Canóvanas, PR. 00729

Coordinates: 18.373613° -65.906549°



Imagery
Date:
1/26/2019



Source: Google Earth

Spatial reference: unknown

Appendix 8c

Historical imagery – Google Earth Pro

Econo Energy Project

Project ID: IPGM-00375

Address: State Road PR-3, Int. PR 9959, Km. 15.21 Bo. Canovanillas, Canóvanas, PR. 00729

Coordinates: 18.373613° -65.906549°



Imagery Date: 5/3/2021



Source: Google Earth

Spatial reference: unknown

Appendix 8d

Contamination and Toxic Substances

Econo Energy Project

Project ID: IPGM-00375

Address: State Road PR-3, Int. PR 9959, Km. 15.21 Bo.

Canovanillas, Canóvanas, PR. 00729

Coordinates: 18.373613° -65.906549°

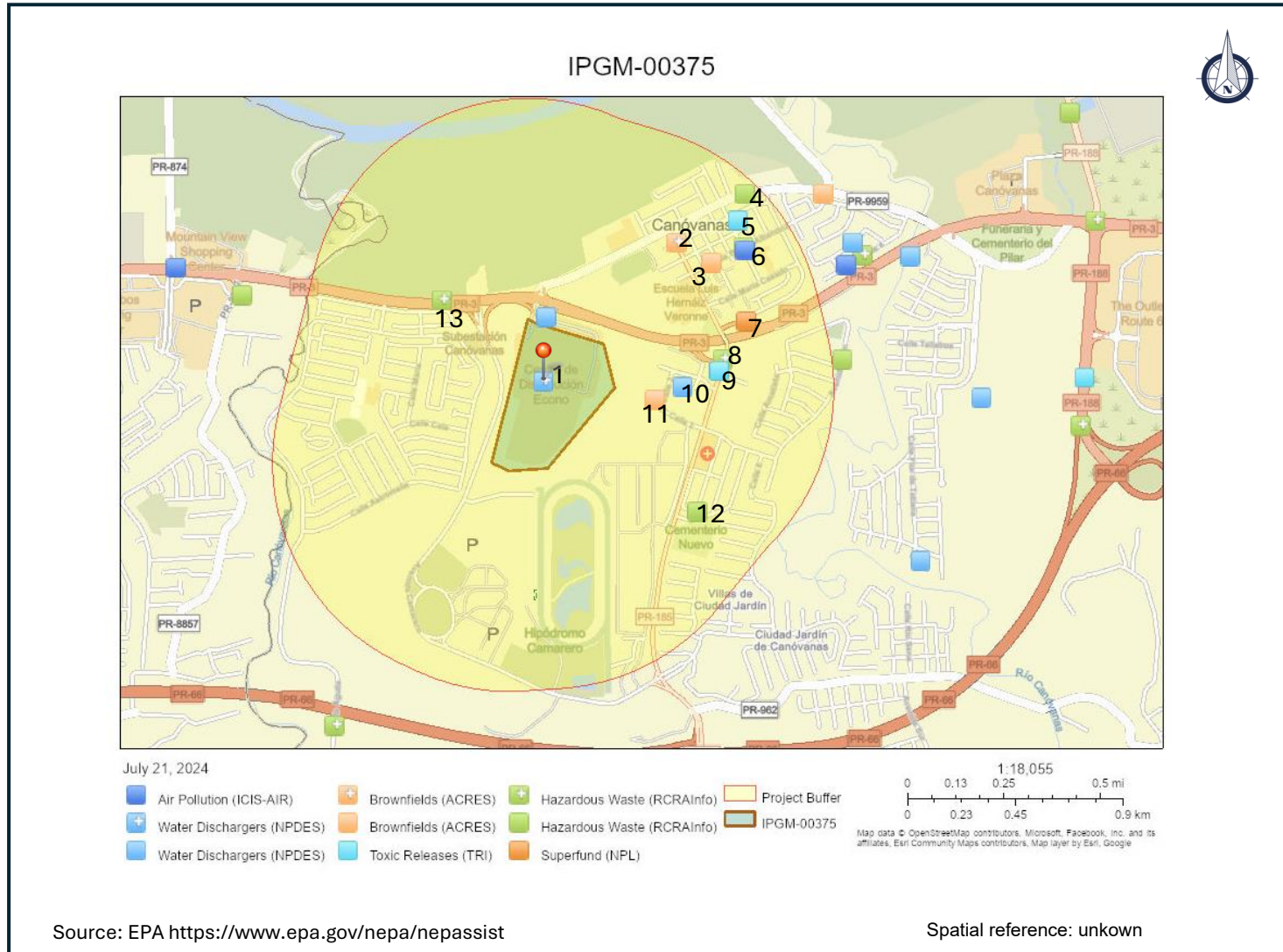
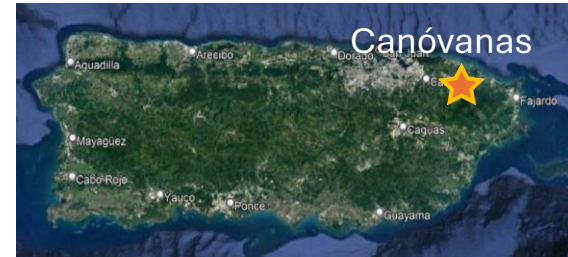

EPA Sites list from NEPAassist

#	Description of facility	EPA facility Type	Distance (ft)	FRS ID	Compliance Status	ECHO Report
1	Centro De Distribucion - Supermercados Econo, Inc. PR-3, INT. PR-9959, KM 15.21, CANOVANILLAS WARD CANOVANAS, PR 00729	Water Dischargers (NPDES)	-	110071222992	No Violation Identified	https://echo.epa.gov/detailed-facility-report?fid=PRR05J02S
2	DowntownS Old Dairy (Site 1-H) AUTONOMÍA STREET AND MUÑOZ RIVERA STREET CORNER CANOVANAS, PR 00729	Brownfields (ACRES)	1,630.73	N/A	N/A	N/A
3	Two Adjacent Abandoned Residences (Site 9-H) #76 & # 78 PEPITA ALBANDOZ STREET CANÓVANAS, PR 00729	Brownfields (ACRES)	1,743.72	N/A	N/A	N/A
	2 sites: --Pillsbury Pr Inc PR-185 KM 0.2 CANOVANAS, PR 007291661	Hazardous Waste (RCRAInfo)	1,481.73	110015588032	No Violation Identified	https://echo.epa.gov/detailed-facility-report?fid=PRN008012692
	--Escuela Luis Hernaiz Verone CALLE AUTONOMIA CANOVANAS, PR 00729	Hazardous Waste (RCRAInfo)	1,482.73	110007811029	No Violation Identified	https://echo.epa.gov/detailed-facility-report?fid=PRD987373552
4	Express Auto Gulf Station 106 PALMER ST CANOVANAS, PR 00729	Hazardous Waste (RCRAInfo)	2,782.36	110004891127	No Violation Identified	https://echo.epa.gov/detailed-facility-report?fid=PRO007002280
5	A & P Proofing Insulation Inc PO BOX 146 CANOVANAS, PR 00729	Toxic Releases (TRI)	2,418.61	110008053355	No data records	https://echo.epa.gov/detailed-facility-report?fid=00629PRFNGPOBOX
6	Canovanas Indian Cleaner 100 CALLE CORCHADO CANOVANAS, PR 00729	Air Pollution (ICIS-AIR)	2,226.31	110005973642	No Violation Identified	https://echo.epa.gov/detailed-facility-report?fid=PR0000007202900015
7	Aluminum Extrusion Corporation STATE ROAD 185 KM. 0.65 CANOVANAS MUNICIPALITY, PR 00729	Superfund (NPL)	1,977.23	110007805688	No Violation Identified	https://echo.epa.gov/detailed-facility-report?fid=110007805688
8	4 sites: --Aluminum Extrusion Corp STATE RD 185 KM 0.65 CANOVANAS, PR 00729-1622	Hazardous Waste (RCRAInfo)	1,977.23	110007805688	No Violation Identified	https://echo.epa.gov/detailed-facility-report?fid=110007805688
	--American Properties Corp PR-874 KM 1.1 CANOVANAS, PR 00729	Hazardous Waste (RCRAInfo)	1,471.65	110007810495	No Violation Identified	https://echo.epa.gov/detailed-facility-report?fid=PRD987369675
	--Brisas De Loiza Stp PR-874 KM 7.1 CANOVANAS, PR 00729	Hazardous Waste (RCRAInfo)	1,472.65	110007803939	No Violation Identified	https://echo.epa.gov/detailed-facility-report?fid=PRD000689331
	--Project Pouch Inc Nsc Pr Inc RD 185 KM 0.6 CANOVANAS, PR 00729	Hazardous Waste (RCRAInfo)	1,473.65			
9	Aluminum Extrusion Corp PR-185 KM 0.65 CANOVANAS, PR 00729	Toxic Releases (TRI)	1,426.38	110007805688	No Violation Identified	https://echo.epa.gov/detailed-facility-report?fid=00629LMNMP185RO
10	Extension Canovanas Plaza Rial li CARR. PR-185 KM 0.07 CANOVANAS, PR 00729	Water Dischargers (NPDES)	832.03	110070568020	Terminated Permit	https://echo.epa.gov/detailed-facility-report?fid=PRR10008A
11	Solares 1 Y 2 Del L-367-0-76 (Site 23) PR-185 KM. 0.9, STREET NO. 3, INDUSTRIAL PARK CANOVANAS, PR 00729	Brownfields (ACRES)	456.96	N/A	N/A	N/A
12	Photoreceptor Systems, Inc. CALLE 2, ESQ 3 CANOVANAS IND. CANOVANAS, PR 00729	Hazardous Waste (RCRAInfo)	1,916.67	110006433564	No Violation Identified	https://echo.epa.gov/detailed-facility-report?fid=PRD980526545
13	2 sites: --Agosto Tire Center & Service Station RD 3 KM 16.1 CANOVANAS, PR 00729	Hazardous Waste (RCRAInfo)	1,319.28	110007814749	No Violation Identified	https://echo.epa.gov/detailed-facility-report?fid=PRO007001597
	--Hipodromo Camarero STATE RD 3 KM 15.3 CANOVANAS, PR 00729	Hazardous Waste (RCRAInfo)	1,320.28	110032966645	No Violation Identified	https://echo.epa.gov/detailed-facility-report?fid=PRR000021196



Detailed Facility Report

Facility Summary

CENTRO DE DISTRIBUCION - SUPERMERCADOS ECONO, INC.

PR-3, INT. PR-9959, KM 15.21, CANOVANILLAS WARD, CANOVANAS, PR 00729

FRS (Facility Registry Service) ID: 110071222992

EPA Region: 02

Latitude: 18.375719

Longitude: -65.906789

Locational Data Source: NPDES

Industries: --

Indian Country: N

Enforcement and Compliance Summary

Statute	CWA
Compliance Monitoring Activities (5 years)	--
Date of Last Compliance Monitoring Activity	--
Compliance Status	No Violation Identified
Qtrs in Noncompliance (of 12)	0
Qtrs with Significant Violation	0
Informal Enforcement Actions (5 years)	--
Formal Enforcement Actions (5 years)	--
Penalties from Formal Enforcement Actions (5 years)	--
EPA Cases (5 years)	--
Penalties from EPA Cases (5 years)	--

Regulatory Information

Clean Air Act (CAA): No Information

Clean Water Act (CWA): Non-Major, Permit Effective (PRR05J02S)

Resource Conservation and Recovery Act (RCRA): No Information

Safe Drinking Water Act (SDWA): No Information

Other Regulatory Reports

Air Emissions Inventory (EIS): No Information

Greenhouse Gas Emissions (eGGRT): No Information

Toxic Releases (TRI): No Information

Compliance and Emissions Data Reporting Interface (CEDRI): No Information

Go To Enforcement/Compliance Details

Known Data Problems <<https://epa.gov/resources/echo-data/known-data-problems>>

Facility/System Characteristics

Facility/System Characteristics

System	Statute	Identifier	Universe	Status	Areas	Permit Expiration Date	Indian Country	Latitude	Longitude
FRS		110071222992					N	18.375719	-65.906789
ICIS-NPDES	CWA	PRR05J02S	Non-Major: General Permit Covered Facility	Effective	Industrial Stormwater	02/28/2026	N	18.37567	-65.906283

Facility Address

System	Statute	Identifier	Facility Name	Facility Address	Facility County
FRS		110071222992	CENTRO DE DISTRIBUCION - SUPERMERCADOS ECONO, INC.	PR-3, INT. PR-9959, KM 15.21, CANOVANILLAS WARD, CANOVANAS, PR 00729	Canóvanas Municipio
ICIS-NPDES	CWA	PRR05J02S	CENTRO DE DISTRIBUCION - SUPERMERCADOS ECONO, INC.	PR-3, INT. PR-9959, KM 15.21, CANOVANILLAS WARD, CANOVANAS, PR 00729	

Facility SIC (Standard Industrial Classification) Codes

System	Identifier	SIC Code	SIC Description
ICIS-NPDES	PRR05J02S	4222	Refrigerated Warehousing And Storage

Facility NAICS (North American Industry Classification System) Codes

System	Identifier	NAICS Code	NAICS Description
--------	------------	------------	-------------------

System	Identifier	SIC Code	SIC Description
ICIS-NPDES	PRR05J025	4225	General Warehousing And Storage

No data records returned

Facility Tribe Information

Facility Industrial Effluent Guidelines

Identifier	Effluent Guideline (40 CFR Part)	Effluent Guideline Description
------------	----------------------------------	--------------------------------

Reservation Name	Tribe Name	EPA Tribal ID	Distance to Tribe (miles)
------------------	------------	---------------	---------------------------

No data records returned

No data records returned

Enforcement and Compliance

Compliance Monitoring History

Last 5 Years

Statute	Source ID	System	Activity Type	Compliance Monitoring Type	Lead Agency	Date	Finding (if applicable)
---------	-----------	--------	---------------	----------------------------	-------------	------	-------------------------

No data records returned

Entries in italics are not included in ECHO's Compliance Monitoring Activity counts because they are not compliance monitoring strategy <https://www.epa.gov/compliance/compliance-monitoring-programs> activities or because they are not counted as inspections within EPA's Annual Results <https://www.epa.gov/enforcement/enforcement-data-and-results>.

Compliance Summary Data

Statute	Source ID	Current SNC (Significant Noncompliance)/HPV (High Priority Violation)	Current As Of	Qtrs with NC (Noncompliance) (of 12)	Data Last Refreshed
CWA	PRR05J025	No	06/30/2024	0	10/18/2024

Three-Year Compliance History by Quarter

Statute	Program/Pollutant/Violation Type	QTR 1	QTR 2	QTR 3	QTR 4	QTR 5	QTR 6	QTR 7	QTR 8	QTR 9	QTR 10	QTR 11	QTR 12	QTR 13
CWA (Source ID: PRR05J025)		07/01-09/30/21	10/01-12/31/21	01/01-03/31/22	04/01-06/30/22	07/01-09/30/22	10/01-12/31/22	01/01-03/31/23	04/01-06/30/23	07/01-09/30/23	10/01-12/31/23	01/01-03/31/24	04/01-06/30/24	07/01-09/30/24
	Facility-Level Status	No Violation Identified	No Violation Identified	No Violation Identified	No Violation Identified	No Violation Identified	No Violation Identified	No Violation Identified	No Violation Identified	No Violation Identified	No Violation Identified	No Violation Identified	No Violation Identified	Undetermined
	Quarterly Noncompliance Report History													

Informal Enforcement Actions

Last 5 Years

Statute	System	Source ID	Type of Action	Lead Agency	Date
---------	--------	-----------	----------------	-------------	------

No data records returned

Entries in italics are not counted as "informal enforcement actions" in EPA policies pertaining to enforcement response tools.

Formal Enforcement Actions

Last 5 Years

Statute	System	Law/Section	Source ID	Type of Action	Case No.	Lead Agency	Case Name	Issued/Filed Date	Settlements/Actions	Settlement/Action Date	Federal Penalty Assessed	State/Local Penalty Assessed	Penalty Amount Collected	SEP Value	Comp Action Cost
---------	--------	-------------	-----------	----------------	----------	-------------	-----------	-------------------	---------------------	------------------------	--------------------------	------------------------------	--------------------------	-----------	------------------

No data records returned

Environmental Conditions

Watersheds

12-Digit WBD (Watershed Boundary Dataset) HUC (RAD (Reach Address Database))	WBD (Watershed Boundary Dataset) Subwatershed Name (RAD (Reach Address Database))	State Water Body Name (ICIS (Integrated Compliance Information System))	Beach Closures Within Last Year	Beach Closures Within Last Two Years	Pollutants Potentially Related to Impairment	Watershed with ESA (Endangered Species Act)-listed Aquatic Species?
210100050414	Rio Grande de Loiza at mouth	BOCAFOMA CREEK WETLAND	No	No	--	Yes

Assessed Waters From Latest State Submission (ATTAINS)

State	Report Cycle	Assessment Unit ID	Assessment Unit Name	Water Condition	Cause Groups Impaired	Drinking Water Use	Ecological Use	Fish Consumption Use	Recreation Use	Other Use
PR	2022	PREE14A	RIO GRANDE DE LOIZA ESTUARY	Impaired - With Restoration Plan	PATHOGENS	--	Insufficient Information	--	Not Supporting	--

Air Quality Nonattainment Areas

Pollutant	Within Nonattainment Status Area?	Nonattainment Status Applicable Standard(s)	Within Maintenance Status Area?	Maintenance Status Applicable Standard(s)
-----------	-----------------------------------	---	---------------------------------	---

No data records returned

Pollutants

Toxics Release Inventory History of Reported Chemicals Released or Transferred in Pounds per Year at Site

TRI Facility ID	Year	Air Emissions	Surface Water Discharges	Off-Site Transfers to POTWs (Publicly Owned Treatment Works)	Underground Injections	Disposal to Land	Total On-Site Releases	Total Off-Site Transfers
-----------------	------	---------------	--------------------------	--	------------------------	------------------	------------------------	--------------------------

No data records returned

Toxics Release Inventory Total Releases and Transfers in Pounds by Chemical and Year ⓘ

Chemical Name

No data records returned

CWA (Clean Water Act) Discharge Monitoring Report (DMR) Pollutant Loadings ⓘ

DMR and TRI Multi-Year Loading Report

NPDES ID

Description

No data records returned

Community

Environmental Justice

This section shows indexes from EJScreen, EPA's screening tool for environmental justice (EJ) concerns. EPA uses these indexes to identify geographic areas that may warrant further consideration or analysis for potential EJ concerns. Use of these indexes does not designate an area as an "EJ community" or "EJ facility." EJScreen provides screening level indicators, not a determination of the existence or absence of EJ concerns. For more information, see the EJScreen home page.



Potential Environmental Justice Concerns

- US Territory
- Supplemental/EJ index percentiles >= 90 (1-mile average)

EJScreen Indexes Shown

Index Type ⌵

Related Reports

EJScreen Community Report

[Download Data](#)

Supplemental Indexes	US (Percentile)			State (Percentile)		
	Facility Census Block Group	1-mile Avg	1-mile Max	Facility Census Block Group	1-mile Avg	1-mile Max
Count of Indexes At or Above 90th Percentile	0	5	7	0	0	4
Particulate Matter 2.5	--	N/A	--	--	N/A	--
Ozone	--	N/A	--	--	N/A	--
Diesel Particulate Matter	0	5	9	10	34	56
Air Toxics Cancer Risk	47	34	57	21	0	ⓘ 96
Air Toxics Respiratory Hazard Index	29	32	43	23	37	ⓘ 96
Toxic Releases to Air	89	ⓘ 98	ⓘ 99	42	73	ⓘ 99
Traffic Proximity	81	ⓘ 97	ⓘ 99	32	66	ⓘ 96
Lead Paint	43	61	ⓘ 99	20	25	ⓘ 94
Risk Management Plan (RMP) Facility Proximity	49	65	86	12	19	38
Hazardous Waste Proximity	71	ⓘ 91	ⓘ 99	24	56	ⓘ 92
Superfund Proximity	84	ⓘ 92	ⓘ 99	28	34	44
Underground Storage Tanks (UST)	76	77	ⓘ 99	62	61	ⓘ 94
Wastewater Discharge	89	ⓘ 94	ⓘ 99	36	39	75

Map Display Based on: US State

Display Map Layer ⌵

Facility 1-mile Radius Facility Census Block Group



Demographic Profile of Surrounding Area (1-Mile Radius)

This section provides demographic information regarding the community surrounding the facility. ECHO compliance data alone are not sufficient to determine whether violations at a particular facility had negative impacts on public health or the environment. Statistics are based upon the 2021 American Community Survey (ACS) 5-year Summary and are accurate to the extent that the facility latitude and longitude listed below are correct. Census boundaries and demographic data for U.S. Territories are based on the "2020 Island Areas Demographic Profiles" from the U.S. Census Bureau. EPA's spatial processing methodology considers the overlap between the selected radii and ACS census block groups in determining the demographics surrounding the facility. For more detail about this methodology, see the DFR Data Dictionary <<https://epa.gov/help/reports/dfr-data-dictionary#demographic>>.

General Statistics (ACS (American Community Survey))	
Total Persons	10,600
Population Density	3,457/sq.mi.
Housing Units in Area	4,165
Percent People of Color	100%
Households in Area	3,570
Households on Public Assistance	144
Persons With Low Income	6,320
Percent With Low Income	60%

Geography	
Radius of Selected Area	1 mi.
Center Latitude	18.375719
Center Longitude	-65.906789
Land Area	98%
Water Area	2%

Income Breakdown (ACS (American Community Survey)) - Households (%)	
Less than \$15,000	723 (20.26%)
\$15,000 - \$25,000	596 (16.7%)
\$25,000 - \$50,000	1,046 (29.31%)
\$50,000 - \$75,000	555 (15.55%)
Greater than \$75,000	649 (18.18%)

Age Breakdown (ACS (American Community Survey)) - Persons (%)	
Children 5 years and younger	358 (3%)
Minors 17 years and younger	1,973 (19%)
Adults 18 years and older	8,626 (81%)
Seniors 65 years and older	1,820 (17%)

Race Breakdown (ACS (American Community Survey)) - Persons (%)	
White	3,938 (37%)
African-American	0 (0%)
Hispanic-Origin	10,571 (100%)
Asian	4 (0%)
Hawaiian/Pacific Islander	0 (0%)
American Indian	3 (0%)
Other/Multiracial	3,331 (31%)

Education Level (Persons 25 & older) (ACS (American Community Survey)) - Persons (%)	
Less than 9th Grade	497 (6.54%)
9th through 12th Grade	379 (4.99%)
High School Diploma	1,932 (25.41%)
Some College/2-year	996 (13.1%)
B.S./B.A. (Bachelor of Science/Bachelor of Arts) or More	2,667 (35.08%)



Detailed Facility Report

Facility Summary

PILLSBURY PR INC

PR-185 KM 0.2, CANOVANAS, PR 00729

FRS (Facility Registry Service) ID: 110015588032

EPA Region: 02

Latitude: 18.377392

Longitude: -65.901155

Locational Data Source: RCRAINFO

Industries: --

Indian Country: N

Enforcement and Compliance Summary

Statute	RCRA
Compliance Monitoring Activities (5 years)	--
Date of Last Compliance Monitoring Activity	--
Compliance Status	No Violation Identified
Qtrs in Noncompliance (of 12)	0
Qtrs with Significant Violation	0
Informal Enforcement Actions (5 years)	--
Formal Enforcement Actions (5 years)	--
Penalties from Formal Enforcement Actions (5 years)	--
EPA Cases (5 years)	--
Penalties from EPA Cases (5 years)	--

Regulatory Information

Clean Air Act (CAA): No Information

Clean Water Act (CWA): No Information

Resource Conservation and Recovery Act (RCRA): Inactive Other, (PRN008012692)

Safe Drinking Water Act (SDWA): No Information

Go To Enforcement/Compliance Details

Known Data Problems <<https://epa.gov/resources/echo-data/known-data-problems>>

Other Regulatory Reports

Air Emissions Inventory (EIS): No Information

Greenhouse Gas Emissions (eGGRT): No Information

Toxic Releases (TRI): No Information

Compliance and Emissions Data Reporting Interface (CEDRI): No Information

Facility/System Characteristics

Facility/System Characteristics

System	Statute	Identifier	Universe	Status	Areas	Permit Expiration Date	Indian Country	Latitude	Longitude
FRS		110015588032					N	18.377392	-65.901155
RCRAInfo	RCRA	PRN008012692	Other	Inactive ()			N	18.377392	-65.901155

Facility Address

System	Statute	Identifier	Facility Name	Facility Address	Facility County
FRS		110015588032	PILLSBURY PR INC	PR-185 KM 0.2, CANOVANAS, PR 00729	Canóvanas Municipio
RCRAInfo	RCRA	PRN008012692	PILLSBURY PR INC	RD 185 KM 0 HM 2, CANOVANAS, PR 00729-1661	Canóvanas Municipio

Facility SIC (Standard Industrial

Facility NAICS (North American Industry

Classification) Codes

System	Identifier	SIC Code	SIC Description
No data records returned			

Classification System) Codes

System	Identifier	NAICS Code	NAICS Description
No data records returned			

Facility Tribe Information

Reservation Name	Tribe Name	EPA Tribal ID	Distance to Tribe (miles)
No data records returned			

Enforcement and Compliance

Compliance Monitoring History Last 5 Years

Statute	Source ID	System	Activity Type	Compliance Monitoring Type	Lead Agency	Date	Finding (if applicable)
No data records returned							

Entries in italics are not included in ECHO's Compliance Monitoring Activity counts because they are not compliance monitoring strategy <<https://www.epa.gov/compliance/compliance-monitoring-programs>> activities or because they are not counted as inspections within EPA's Annual Results <<https://www.epa.gov/enforcement/enforcement-data-and-results>>.

Compliance Summary Data

Statute	Source ID	Current SNC (Significant Noncompliance)/HPV (High Priority Violation)	Current As Of	Qtrs with NC (Noncompliance) (of 12)	Data Last Refreshed
RCRA	PRN008012692	No	10/19/2024	0	10/18/2024

Three-Year Compliance History by Quarter

Statute	Program/Pollutant/Violation Type	QTR 1	QTR 2	QTR 3	QTR 4	QTR 5	QTR 6	QTR 7	QTR 8	QTR 9	QTR 10	QTR 11	QTR 12+
RCRA (Source ID: PRN008012692)		10/01-12/31/21	01/01-03/31/22	04/01-06/30/22	07/01-09/30/22	10/01-12/31/22	01/01-03/31/23	04/01-06/30/23	07/01-09/30/23	10/01-12/31/23	01/01-03/31/24	04/01-06/30/24	07/01-09/30/24
	Facility-Level Status	No Violation Identified	No Violation Identified	No Violation Identified	No Violation Identified	No Violation Identified	No Violation Identified	No Violation Identified	No Violation Identified	No Violation Identified	No Violation Identified	No Violation Identified	No Violation Identified
	Violation												
	Agency												

Informal Enforcement Actions Last 5 Years

Statute	System	Source ID	Type of Action	Lead Agency	Date
No data records returned					

Entries in italics are not counted as "informal enforcement actions" in EPA policies pertaining to enforcement response tools.

Formal Enforcement Actions Last 5 Years

Statute	System	Law/Section	Source ID	Type of Action	Case No.	Lead Agency	Case Name	Issued/ Filed Date	Settlements/ Actions	Settlement/ Action Date	Federal Penalty Assessed	State/ Local Penalty Assessed	Penalty Amount Collected	SEP Value	Comp Action Cost
No data records returned															

Environmental Conditions

Watersheds

12-Digit WBD (Watershed Boundary Dataset) HUC (RAD (Reach Address Database))	WBD (Watershed Boundary Dataset) Subwatershed Name (RAD (Reach Address Database))	State Water Body Name (ICIS (Integrated Compliance Information System))	Beach Closures Within Last Year	Beach Closures Within Last Two Years	Pollutants Potentially Related to Impairment	Watershed with ESA (Endangered Species Act)-listed Aquatic Species?
No data records returned						

Assessed Waters From Latest State Submission (ATTAINS)

State	Report Cycle	Assessment Unit ID	Assessment Unit Name	Water Condition	Cause Groups Impaired	Drinking Water Use	Ecological Use	Fish Consumption Use	Recreation Use	Other Use
No data records returned										

Air Quality Nonattainment Areas

Pollutant	Within Nonattainment Status Area?	Nonattainment Status Applicable Standard(s)	Within Maintenance Status Area?	Maintenance Status Applicable Standard(s)
No data records returned				

Pollutants

Toxics Release Inventory History of Reported Chemicals Released or Transferred in Pounds per

Year at Site ⓘ

TRI Facility ID Year Air Emissions Surface Water Discharges Off-Site Transfers to POTWs (Publicly Owned Treatment Works) Underground Injections Disposal to Land Total On-Site Releases Total Off-Site Transfers

No data records returned

Toxics Release Inventory Total Releases and Transfers in Pounds by Chemical and Year ⓘ

Chemical Name

No data records returned

Community

Environmental Justice

This section shows indexes from EJScreen, EPA's screening tool for environmental justice (EJ) concerns. EPA uses these indexes to identify geographic areas that may warrant further consideration or analysis for potential EJ concerns. Use of these indexes does not designate an area as an "EJ community" or "EJ facility." EJScreen provides screening level indicators, not a determination of the existence or absence of EJ concerns. For more information, see the EJScreen home page.



Potential Environmental Justice Concerns

- US Territory
- Supplemental/EJ index percentiles >= 90 (Census block group)
- Supplemental/EJ index percentiles >= 90 (1-mile average)

EJScreen Indexes Shown

Index Type

Supplemental (default) ⌵

Related Reports

EJScreen Community Report

[Download Data](#)

Supplemental Indexes	US (Percentile)			State (Percentile)		
	Facility Census Block Group	1-mile Avg	1-mile Max	Facility Census Block Group	1-mile Avg	1-mile Max
Count of Indexes At or Above 90th Percentile	7	3	7	4	0	4
Particulate Matter 2.5	--	N/A	--	--	N/A	--
Ozone	--	N/A	--	--	N/A	--
Diesel Particulate Matter	5	4	9	52	27	56
Air Toxics Cancer Risk	54	33	57	79	0	96
Air Toxics Respiratory Hazard Index	37	31	43	79	30	96
Toxic Releases to Air	99	97	99	96	66	99
Traffic Proximity	99	94	99	96	55	96
Lead Paint	99	53	99	94	22	94
Risk Management Plan (RMP) Facility Proximity	76	58	86	25	15	38
Hazardous Waste Proximity	97	85	99	72	43	92
Superfund Proximity	97	88	99	44	30	44
Underground Storage Tanks (UST)	99	76	99	92	61	94
Wastewater Discharge	99	92	99	70	38	75

Map Display Based on: US State

Display Map Layer

Summary - Number of Indexes ⌵

Facility 1-mile Radius Facility Census Block Group



Demographic Profile of Surrounding Area (1-Mile Radius)

This section provides demographic information regarding the community surrounding the facility. ECHO compliance data alone are not sufficient to determine whether violations at a particular facility had negative impacts on public health or the environment. Statistics are based upon the 2021 American Community Survey (ACS) 5-year Summary and are accurate to the extent that the facility latitude and longitude listed below are correct. Census boundaries and demographic data for U.S. Territories are based on the "2020 Island Areas Demographic Profiles" from the U.S. Census Bureau. EPA's spatial processing methodology considers the overlap between the selected radii and ACS census block groups in determining the demographics surrounding the facility. For more detail about this methodology, see the DFR Data Dictionary <<https://epa.gov/help/reports/dfr-data-dictionary#demographic>>.

General Statistics (ACS (American Community Survey))	
Total Persons	9,524
Population Density	3,104/sq.mi.
Housing Units in Area	3,722
Percent People of Color	100%
Households in Area	3,198
Households on Public Assistance	122
Persons With Low Income	5,569
Percent With Low Income	59%

Geography	
Radius of Selected Area	1 mi.
Center Latitude	18.377392
Center Longitude	-65.901155
Land Area	98%
Water Area	2%

Income Breakdown (ACS (American Community Survey)) - Households (%)	
Less than \$15,000	666 (20.82%)
\$15,000 - \$25,000	531 (16.6%)
\$25,000 - \$50,000	928 (29.01%)
\$50,000 - \$75,000	452 (14.13%)
Greater than \$75,000	622 (19.44%)

Age Breakdown (ACS (American Community Survey)) - Persons (%)	
Children 5 years and younger	353 (4%)
Minors 17 years and younger	1,808 (19%)
Adults 18 years and older	7,716 (81%)
Seniors 65 years and older	1,579 (17%)

Race Breakdown (ACS (American Community Survey)) - Persons (%)	
White	3,454 (36%)
African-American	0 (0%)
Hispanic-Origin	9,496 (100%)
Asian	16 (0%)
Hawaiian/Pacific Islander	0 (0%)
American Indian	9 (0%)
Other/Multiracial	3,009 (32%)

Education Level (Persons 25 & older) (ACS (American Community Survey)) - Persons (%)	
Less than 9th Grade	508 (7.51%)
9th through 12th Grade	344 (5.08%)
High School Diploma	1,612 (23.83%)
Some College/2-year	893 (13.2%)
B.S./B.A. (Bachelor of Science/Bachelor of Arts) or More	2,362 (34.92%)



Detailed Facility Report

Facility Summary

ESCUELA LUIS HERNAIZ VERONE

CALLE AUTONOMIA, CANOVANAS, PR 00729

FRS (Facility Registry Service) ID: 110007811029

EPA Region: 02

Latitude: 18.377041

Longitude: -65.900862

Locational Data Source: RCRAINFO

Industries: --

Indian Country: N

Enforcement and Compliance Summary

Statute	RCRA
Compliance Monitoring Activities (5 years)	--
Date of Last Compliance Monitoring Activity	--
Compliance Status	No Violation Identified
Qtrs in Noncompliance (of 12)	0
Qtrs with Significant Violation	0
Informal Enforcement Actions (5 years)	--
Formal Enforcement Actions (5 years)	--
Penalties from Formal Enforcement Actions (5 years)	--
EPA Cases (5 years)	--
Penalties from EPA Cases (5 years)	--

Regulatory Information

Clean Air Act (CAA): No Information

Clean Water Act (CWA): No Information

Resource Conservation and Recovery Act (RCRA): Inactive Other, (PRD987373552)

Safe Drinking Water Act (SDWA): No Information

Other Regulatory Reports

Air Emissions Inventory (EIS): No Information

Greenhouse Gas Emissions (eGGRT): No Information

Toxic Releases (TRI): No Information

Compliance and Emissions Data Reporting Interface (CEDRI): No Information

Go To Enforcement/Compliance Details

Known Data Problems <<https://epa.gov/resources/echo-data/known-data-problems>>

Facility/System Characteristics

Facility/System Characteristics

System	Statute	Identifier	Universe	Status	Areas	Permit Expiration Date	Indian Country	Latitude	Longitude
FRS		110007811029					N	18.377041	-65.900862
RCRAInfo	RCRA	PRD987373552	Other	Inactive ()			N	18.377041	-65.900862

Facility Address

System	Statute	Identifier	Facility Name	Facility Address	Facility County
FRS		110007811029	ESCUELA LUIS HERNAIZ VERONE	CALLE AUTONOMIA, CANOVANAS, PR 00729	Canóvanas Municipio
RCRAInfo	RCRA	PRD987373552	ESCUELA LUIS HERNAIZ VERONE	CALLE AUTONOMIA, CANOVANAS, PR 00629	Canóvanas Municipio

Facility SIC (Standard Industrial

Facility NAICS (North American Industry

Classification) Codes

System	Identifier	SIC Code	SIC Description
No data records returned			

Classification System) Codes

System	Identifier	NAICS Code	NAICS Description
No data records returned			

Facility Tribe Information

Reservation Name	Tribe Name	EPA Tribal ID	Distance to Tribe (miles)
No data records returned			

Enforcement and Compliance

Compliance Monitoring History Last 5 Years

Statute	Source ID	System	Activity Type	Compliance Monitoring Type	Lead Agency	Date	Finding (if applicable)
No data records returned							

Entries in italics are not included in ECHO's Compliance Monitoring Activity counts because they are not compliance monitoring strategy <<https://www.epa.gov/compliance/compliance-monitoring-programs>> activities or because they are not counted as inspections within EPA's Annual Results <<https://www.epa.gov/enforcement/enforcement-data-and-results>>.

Compliance Summary Data

Statute	Source ID	Current SNC (Significant Noncompliance)/HPV (High Priority Violation)	Current As Of	Qtrs with NC (Noncompliance) (of 12)	Data Last Refreshed
RCRA	PRD987373552	No	10/19/2024	0	10/18/2024

Three-Year Compliance History by Quarter

Statute	Program/Pollutant/Violation Type	QTR 1	QTR 2	QTR 3	QTR 4	QTR 5	QTR 6	QTR 7	QTR 8	QTR 9	QTR 10	QTR 11	QTR 12+
RCRA (Source ID: PRD987373552)		10/01-12/31/21	01/01-03/31/22	04/01-06/30/22	07/01-09/30/22	10/01-12/31/22	01/01-03/31/23	04/01-06/30/23	07/01-09/30/23	10/01-12/31/23	01/01-03/31/24	04/01-06/30/24	07/01-09/30/24
	Facility-Level Status	No Violation Identified	No Violation Identified	No Violation Identified	No Violation Identified	No Violation Identified	No Violation Identified	No Violation Identified	No Violation Identified	No Violation Identified	No Violation Identified	No Violation Identified	No Violation Identified
	Violation												
	Agency												

Informal Enforcement Actions Last 5 Years

Statute	System	Source ID	Type of Action	Lead Agency	Date
No data records returned					

Entries in italics are not counted as "informal enforcement actions" in EPA policies pertaining to enforcement response tools.

Formal Enforcement Actions Last 5 Years

Statute	System	Law/Section	Source ID	Type of Action	Case No.	Lead Agency	Case Name	Issued/ Filed Date	Settlements/ Actions	Settlement/ Action Date	Federal Penalty Assessed	State/ Local Penalty Assessed	Penalty Amount Collected	SEP Value	Comp Action Cost
No data records returned															

Environmental Conditions

Watersheds

12-Digit WBD (Watershed Boundary Dataset) HUC (RAD (Reach Address Database))	WBD (Watershed Boundary Dataset) Subwatershed Name (RAD (Reach Address Database))	State Water Body Name (ICIS (Integrated Compliance Information System))	Beach Closures Within Last Year	Beach Closures Within Last Two Years	Pollutants Potentially Related to Impairment	Watershed with ESA (Endangered Species Act)-listed Aquatic Species?
No data records returned						

Assessed Waters From Latest State Submission (ATTAINS)

State	Report Cycle	Assessment Unit ID	Assessment Unit Name	Water Condition	Cause Groups Impaired	Drinking Water Use	Ecological Use	Fish Consumption Use	Recreation Use	Other Use
No data records returned										

Air Quality Nonattainment Areas

Pollutant	Within Nonattainment Status Area?	Nonattainment Status Applicable Standard(s)	Within Maintenance Status Area?	Maintenance Status Applicable Standard(s)
No data records returned				

Pollutants

Toxics Release Inventory History of Reported Chemicals Released or Transferred in Pounds per

Year at Site ⓘ

TRI Facility ID Year Air Emissions Surface Water Discharges Off-Site Transfers to POTWs (Publicly Owned Treatment Works) Underground Injections Disposal to Land Total On-Site Releases Total Off-Site Transfers

No data records returned

Toxics Release Inventory Total Releases and Transfers in Pounds by Chemical and Year ⓘ

Chemical Name

No data records returned

Community

Environmental Justice

This section shows indexes from EJScreen, EPA's screening tool for environmental justice (EJ) concerns. EPA uses these indexes to identify geographic areas that may warrant further consideration or analysis for potential EJ concerns. Use of these indexes does not designate an area as an "EJ community" or "EJ facility." EJScreen provides screening level indicators, not a determination of the existence or absence of EJ concerns. For more information, see the EJScreen home page.



Potential Environmental Justice Concerns

- US Territory
- Supplemental/EJ index percentiles >= 90 (Census block group)
- Supplemental/EJ index percentiles >= 90 (1-mile average)

EJScreen Indexes Shown

Index Type

Supplemental (default) ⌵

Related Reports

EJScreen Community Report

[Download Data](#)

Supplemental Indexes	US (Percentile)			State (Percentile)		
	Facility Census Block Group	1-mile Avg	1-mile Max	Facility Census Block Group	1-mile Avg	1-mile Max
Count of Indexes At or Above 90th Percentile	7	3	7	4	0	4
Particulate Matter 2.5	--	N/A	--	--	N/A	--
Ozone	--	N/A	--	--	N/A	--
Diesel Particulate Matter	5	4	9	52	27	56
Air Toxics Cancer Risk	54	33	57	79	0	ⓘ 96
Air Toxics Respiratory Hazard Index	37	31	43	79	29	ⓘ 96
Toxic Releases to Air	ⓘ 99	ⓘ 97	ⓘ 99	ⓘ 96	66	ⓘ 99
Traffic Proximity	ⓘ 99	ⓘ 94	ⓘ 99	ⓘ 96	55	ⓘ 96
Lead Paint	ⓘ 99	53	ⓘ 99	ⓘ 94	22	ⓘ 94
Risk Management Plan (RMP) Facility Proximity	76	58	86	25	15	38
Hazardous Waste Proximity	ⓘ 97	85	ⓘ 99	72	43	ⓘ 92
Superfund Proximity	ⓘ 97	88	ⓘ 99	44	30	44
Underground Storage Tanks (UST)	ⓘ 99	76	ⓘ 99	ⓘ 92	61	ⓘ 94
Wastewater Discharge	ⓘ 99	ⓘ 92	ⓘ 99	70	38	75

Map Display Based on: US State

Display Map Layer

Summary - Number of Indexes ⌵

Facility 1-mile Radius Facility Census Block Group



Demographic Profile of Surrounding Area (1-Mile Radius)

This section provides demographic information regarding the community surrounding the facility. ECHO compliance data alone are not sufficient to determine whether violations at a particular facility had negative impacts on public health or the environment. Statistics are based upon the 2021 American Community Survey (ACS) 5-year Summary and are accurate to the extent that the facility latitude and longitude listed below are correct. Census boundaries and demographic data for U.S. Territories are based on the "2020 Island Areas Demographic Profiles" from the U.S. Census Bureau. EPA's spatial processing methodology considers the overlap between the selected radii and ACS census block groups in determining the demographics surrounding the facility. For more detail about this methodology, see the DFR Data Dictionary <<https://epa.gov/help/reports/dfr-data-dictionary#demographic>>.

General Statistics (ACS (American Community Survey))	
Total Persons	9,549
Population Density	3,110/sq.mi.
Housing Units in Area	3,711
Percent People of Color	100%
Households in Area	3,196
Households on Public Assistance	121
Persons With Low Income	5,515
Percent With Low Income	58%

Geography	
Radius of Selected Area	1 mi.
Center Latitude	18.377041
Center Longitude	-65.900862
Land Area	98%
Water Area	2%

Income Breakdown (ACS (American Community Survey)) - Households (%)	
Less than \$15,000	654 (20.45%)
\$15,000 - \$25,000	524 (16.39%)
\$25,000 - \$50,000	922 (28.83%)
\$50,000 - \$75,000	458 (14.32%)
Greater than \$75,000	640 (20.01%)

Age Breakdown (ACS (American Community Survey)) - Persons (%)	
Children 5 years and younger	359 (4%)
Minors 17 years and younger	1,826 (19%)
Adults 18 years and older	7,721 (81%)
Seniors 65 years and older	1,562 (16%)

Race Breakdown (ACS (American Community Survey)) - Persons (%)	
White	3,503 (37%)
African-American	0 (0%)
Hispanic-Origin	9,521 (100%)
Asian	17 (0%)
Hawaiian/Pacific Islander	0 (0%)
American Indian	10 (0%)
Other/Multiracial	2,995 (31%)

Education Level (Persons 25 & older) (ACS (American Community Survey)) - Persons (%)	
Less than 9th Grade	492 (7.28%)
9th through 12th Grade	340 (5.03%)
High School Diploma	1,590 (23.52%)
Some College/2-year	895 (13.24%)
B.S./B.A. (Bachelor of Science/Bachelor of Arts) or More	2,394 (35.41%)



Detailed Facility Report

Facility Summary

EXPRESS AUTO GULF STATION

106 PALMER ST, CANOVANAS, PR 00729

FRS (Facility Registry Service) ID: 110004891127

EPA Region: 02

Latitude: 18.380333

Longitude: -65.89894

Locational Data Source: FRS

Industries: --

Indian Country: N

Enforcement and Compliance Summary

Statute	RCRA
Compliance Monitoring Activities (5 years)	--
Date of Last Compliance Monitoring Activity	05/22/1997
Compliance Status	No Violation Identified
Qtrs in Noncompliance (of 12)	0
Qtrs with Significant Violation	0
Informal Enforcement Actions (5 years)	--
Formal Enforcement Actions (5 years)	--
Penalties from Formal Enforcement Actions (5 years)	--
EPA Cases (5 years)	--
Penalties from EPA Cases (5 years)	--

Regulatory Information

Clean Air Act (CAA): No Information

Clean Water Act (CWA): No Information

Resource Conservation and Recovery Act (RCRA): Inactive Other, (PRO007002280)

Safe Drinking Water Act (SDWA): No Information

Go To Enforcement/Compliance Details

Known Data Problems <<https://epa.gov/resources/echo-data/known-data-problems>>

Other Regulatory Reports

Air Emissions Inventory (EIS): No Information

Greenhouse Gas Emissions (eGGRT): No Information

Toxic Releases (TRI): No Information

Compliance and Emissions Data Reporting Interface (CEDRI): No Information

Facility/System Characteristics

Facility/System Characteristics

System	Statute	Identifier	Universe	Status	Areas	Permit Expiration Date	Indian Country	Latitude	Longitude
FRS		110004891127					N	18.380333	-65.89894
RCRAInfo	RCRA	PRO007002280	Other	Inactive ()			N	18.379999	-65.899865

Facility Address

System	Statute	Identifier	Facility Name	Facility Address	Facility County
FRS		110004891127	EXPRESS AUTO GULF STATION	106 PALMER ST, CANOVANAS, PR 00729	Canóvanas Municipio
RCRAInfo	RCRA	PRO007002280	EXPRESS AUTO GULF STATION	106 PALMER ST, CANOVANAS, PR 00729	Canóvanas Municipio

Facility SIC (Standard Industrial

Facility NAICS (North American Industry

Classification) Codes

System	Identifier	SIC Code	SIC Description
No data records returned			

Classification System) Codes

System	Identifier	NAICS Code	NAICS Description
No data records returned			

Facility Tribe Information

Reservation Name	Tribe Name	EPA Tribal ID	Distance to Tribe (miles)
No data records returned			

Enforcement and Compliance

Compliance Monitoring History Last 5 Years

Statute	Source ID	System	Activity Type	Compliance Monitoring Type	Lead Agency	Date	Finding (if applicable)
No data records returned							

Entries in italics are not included in ECHO's Compliance Monitoring Activity counts because they are not compliance monitoring strategy <<https://www.epa.gov/compliance/compliance-monitoring-programs>> activities or because they are not counted as inspections within EPA's Annual Results <<https://www.epa.gov/enforcement/enforcement-data-and-results>>.

Compliance Summary Data

Statute	Source ID	Current SNC (Significant Noncompliance)/HPV (High Priority Violation)	Current As Of	Qtrs with NC (Noncompliance) (of 12)	Data Last Refreshed
RCRA	PRO007002280	No	10/19/2024	0	10/18/2024

Three-Year Compliance History by Quarter

Statute	Program/Pollutant/Violation Type	QTR 1	QTR 2	QTR 3	QTR 4	QTR 5	QTR 6	QTR 7	QTR 8	QTR 9	QTR 10	QTR 11	QTR 12+
RCRA	(Source ID: PRO007002280)	10/01-12/31/21	01/01-03/31/22	04/01-06/30/22	07/01-09/30/22	10/01-12/31/22	01/01-03/31/23	04/01-06/30/23	07/01-09/30/23	10/01-12/31/23	01/01-03/31/24	04/01-06/30/24	07/01-09/30/24
	Facility-Level Status	No Violation Identified	No Violation Identified	No Violation Identified	No Violation Identified	No Violation Identified	No Violation Identified	No Violation Identified	No Violation Identified	No Violation Identified	No Violation Identified	No Violation Identified	No Violation Identified
	Violation												
	Agency												

Informal Enforcement Actions Last 5 Years

Statute	System	Source ID	Type of Action	Lead Agency	Date
No data records returned					

Entries in italics are not counted as "informal enforcement actions" in EPA policies pertaining to enforcement response tools.

Formal Enforcement Actions Last 5 Years

Statute	System	Law/Section	Source ID	Type of Action	Case No.	Lead Agency	Case Name	Issued/ Filed Date	Settlements/ Actions	Settlement/ Action Date	Federal Penalty Assessed	State/ Local Penalty Assessed	Penalty Amount Collected	SEP Value	Comp Action Cost
No data records returned															

Environmental Conditions

Watersheds

12-Digit WBD (Watershed Boundary Dataset) HUC (RAD (Reach Address Database))	WBD (Watershed Boundary Dataset) Subwatershed Name (RAD (Reach Address Database))	State Water Body Name (ICIS (Integrated Compliance Information System))	Beach Closures Within Last Year	Beach Closures Within Last Two Years	Pollutants Potentially Related to Impairment	Watershed with ESA (Endangered Species Act)-listed Aquatic Species?
No data records returned						

Assessed Waters From Latest State Submission (ATTAINS)

State	Report Cycle	Assessment Unit ID	Assessment Unit Name	Water Condition	Cause Groups Impaired	Drinking Water Use	Ecological Use	Fish Consumption Use	Recreation Use	Other Use
No data records returned										

Air Quality Nonattainment Areas

Pollutant	Within Nonattainment Status Area?	Nonattainment Status Applicable Standard(s)	Within Maintenance Status Area?	Maintenance Status Applicable Standard(s)
No data records returned				

Pollutants

Toxics Release Inventory History of Reported Chemicals Released or Transferred in Pounds per

Year at Site ⓘ

TRI Facility ID Year Air Emissions Surface Water Discharges Off-Site Transfers to POTWs (Publicly Owned Treatment Works) Underground Injections Disposal to Land Total On-Site Releases Total Off-Site Transfers

No data records returned

Toxics Release Inventory Total Releases and Transfers in Pounds by Chemical and Year ⓘ

Chemical Name

No data records returned

Community

Environmental Justice

This section shows indexes from EJScreen, EPA's screening tool for environmental justice (EJ) concerns. EPA uses these indexes to identify geographic areas that may warrant further consideration or analysis for potential EJ concerns. Use of these indexes does not designate an area as an "EJ community" or "EJ facility." EJScreen provides screening level indicators, not a determination of the existence or absence of EJ concerns. For more information, see the EJScreen home page.



Potential Environmental Justice Concerns

- US Territory
- Supplemental/EJ index percentiles >= 90 (Census block group)
- Supplemental/EJ index percentiles >= 90 (1-mile average)

EJScreen Indexes Shown

Index Type

Supplemental (default) ⌵

Related Reports

EJScreen Community Report

[Download Data](#)

Supplemental Indexes	US (Percentile)			State (Percentile)		
	Facility Census Block Group	1-mile Avg	1-mile Max	Facility Census Block Group	1-mile Avg	1-mile Max
Count of Indexes At or Above 90th Percentile	7	3	7	0	0	4
Particulate Matter 2.5	--	N/A	--	--	N/A	--
Ozone	--	N/A	--	--	N/A	--
Diesel Particulate Matter	4	3	9	40	24	56
Air Toxics Cancer Risk	52	33	57	49	0	96
Air Toxics Respiratory Hazard Index	34	31	43	50	32	96
Toxic Releases to Air	99	97	99	83	68	99
Traffic Proximity	99	95	99	78	58	96
Lead Paint	97	58	99	77	24	94
Risk Management Plan (RMP) Facility Proximity	68	58	86	20	15	38
Hazardous Waste Proximity	93	84	99	59	41	92
Superfund Proximity	94	89	99	36	30	44
Underground Storage Tanks (UST)	92	83	99	72	62	94
Wastewater Discharge	98	93	99	59	40	75

Map Display Based on: US State

Display Map Layer

Summary - Number of Indexes ⌵

Facility 1-mile Radius Facility Census Block Group



Demographic Profile of Surrounding Area (1-Mile Radius)

This section provides demographic information regarding the community surrounding the facility. ECHO compliance data alone are not sufficient to determine whether violations at a particular facility had negative impacts on public health or the environment. Statistics are based upon the 2021 American Community Survey (ACS) 5-year Summary and are accurate to the extent that the facility latitude and longitude listed below are correct. Census boundaries and demographic data for U.S. Territories are based on the "2020 Island Areas Demographic Profiles" from the U.S. Census Bureau. EPA's spatial processing methodology considers the overlap between the selected radii and ACS census block groups in determining the demographics surrounding the facility. For more detail about this methodology, see the DFR Data Dictionary <<https://epa.gov/help/reports/dfr-data-dictionary#demographic>>.

General Statistics (ACS (American Community Survey))	
Total Persons	8,011
Population Density	2,614/sq.mi.
Housing Units in Area	3,383
Percent People of Color	100%
Households in Area	2,824
Households on Public Assistance	111
Persons With Low Income	4,939
Percent With Low Income	62%

Geography	
Radius of Selected Area	1 mi.
Center Latitude	18.380333
Center Longitude	-65.89894
Land Area	98%
Water Area	2%

Income Breakdown (ACS (American Community Survey)) - Households (%)	
Less than \$15,000	727 (25.76%)
\$15,000 - \$25,000	541 (19.17%)
\$25,000 - \$50,000	726 (25.73%)
\$50,000 - \$75,000	329 (11.66%)
Greater than \$75,000	499 (17.68%)

Age Breakdown (ACS (American Community Survey)) - Persons (%)	
Children 5 years and younger	288 (4%)
Minors 17 years and younger	1,537 (19%)
Adults 18 years and older	6,473 (81%)
Seniors 65 years and older	1,296 (16%)

Race Breakdown (ACS (American Community Survey)) - Persons (%)	
White	2,827 (35%)
African-American	0 (0%)
Hispanic-Origin	7,985 (100%)
Asian	38 (0%)
Hawaiian/Pacific Islander	0 (0%)
American Indian	10 (0%)
Other/Multiracial	2,820 (35%)

Education Level (Persons 25 & older) (ACS (American Community Survey)) - Persons (%)	
Less than 9th Grade	731 (12.82%)
9th through 12th Grade	302 (5.3%)
High School Diploma	1,331 (23.35%)
Some College/2-year	708 (12.42%)
B.S./B.A. (Bachelor of Science/Bachelor of Arts) or More	1,769 (31.03%)



Detailed Facility Report

Facility Summary

A & P PROOFING INSULATION INC

PO BOX 146, CANOVANAS, PR 00729

FRS (Facility Registry Service) ID: 110008053355

EPA Region: 02

Latitude: 18.379343

Longitude: -65.899218

Locational Data Source: TRIS

Industries: Chemical Manufacturing

Indian Country: N

Enforcement and Compliance Summary

No data records returned

Regulatory Information

Clean Air Act (CAA): No Information

Clean Water Act (CWA): No Information

Resource Conservation and Recovery Act (RCRA): No Information

Safe Drinking Water Act (SDWA): No Information

Other Regulatory Reports

Air Emissions Inventory (EIS): No Information

Greenhouse Gas Emissions (eGGRT): No Information

Toxic Releases (TRI): 00629PRFNGPOBOX

Compliance and Emissions Data Reporting Interface (CEDRI):
No Information

Go To Enforcement/Compliance Details

Known Data Problems <<https://epa.gov/resources/echo-data/known-data-problems>>

Facility/System Characteristics

Facility/System Characteristics

System	Statute	Identifier	Universe	Status	Areas	Permit Expiration Date	Indian Country	Latitude	Longitude
FRS		110008053355					N	18.379343	-65.899218
TRI	EP313	00629PRFNGPOBOX	Toxics Release Inventory	Last Reported for 1988			N	18.379343	-65.899218

Facility Address

System	Statute	Identifier	Facility Name	Facility Address	Facility County
FRS		110008053355	A & P PROOFING INSULATION INC	PO BOX 146, CANOVANAS, PR 00729	Canóvanas Municipio
TRI	EP313	00629PRFNGPOBOX	A & P PROOFING INSULATION INC	PO BOX 146, CANOVANAS, PR 00729	Canóvanas Municipio

Facility SIC (Standard Industrial Classification) Codes

System	Identifier	SIC Code	SIC Description
TRI	00629PRFNGPOBOX	2890	Legacy Docket Conv
TRI	00629PRFNGPOBOX	2891	Adhesives And Sealants

Facility NAICS (North American Industry Classification System) Codes

System	Identifier	NAICS Code	NAICS Description
TRI	00629PRFNGPOBOX	325520	Adhesive Manufacturing

Facility Tribe Information

Reservation Name	Tribe Name	EPA Tribal ID	Distance to Tribe (miles)
------------------	------------	---------------	---------------------------

No data records returned

Enforcement and Compliance

Compliance Monitoring History

Last 5 Years 

Statute	Source ID	System	Activity Type	Compliance Monitoring Type	Lead Agency	Date	Finding (if applicable)
---------	-----------	--------	---------------	----------------------------	-------------	------	-------------------------

No data records returned

Entries in italics are not included in ECHO's Compliance Monitoring Activity counts because they are not compliance monitoring strategy <<https://www.epa.gov/compliance/compliance-monitoring-programs>> activities or because they are not counted as inspections within EPA's Annual Results <<https://www.epa.gov/enforcement/enforcement-data-and-results>>.

Compliance Summary Data

Statute	Source ID	Current SNC (Significant Noncompliance)/HPV (High Priority Violation)	Current As Of	Qtrs with NC (Noncompliance) (of 12)	Data Last Refreshed
---------	-----------	---	---------------	--------------------------------------	---------------------

No data records returned

Three-Year Compliance History by Quarter

Informal Enforcement Actions

Last 5 Years 

Statute	System	Source ID	Type of Action	Lead Agency	Date
---------	--------	-----------	----------------	-------------	------

No data records returned

Entries in italics are not counted as "informal enforcement actions" in EPA policies pertaining to enforcement response tools.

Formal Enforcement Actions

Last 5 Years 

Statute	System	Law/Section	Source ID	Type of Action	Case No.	Lead Agency	Case Name	Issued/Filed Date	Settlements/Actions	Settlement/Action Date	Federal Penalty Assessed	State/Local Penalty Assessed	Penalty Amount Collected	SEP Value	Comp Action Cost
---------	--------	-------------	-----------	----------------	----------	-------------	-----------	-------------------	---------------------	------------------------	--------------------------	------------------------------	--------------------------	-----------	------------------

No data records returned

Environmental Conditions

Watersheds

12-Digit WBD (Watershed Boundary Dataset) HUC (RAD (Reach Address Database))	WBD (Watershed Boundary Dataset) Subwatershed Name (RAD (Reach Address Database))	State Water Body Name (ICIS (Integrated Compliance Information System))	Beach Closures Within Last Year	Beach Closures Within Last Two Years	Pollutants Potentially Related to Impairment	Watershed with ESA (Endangered Species Act)-listed Aquatic Species?
--	---	---	---------------------------------	--------------------------------------	--	---

No data records returned

Assessed Waters From Latest State Submission (ATTAINS)

State	Report Cycle	Assessment Unit ID	Assessment Unit Name	Water Condition	Cause Groups Impaired	Drinking Water Use	Ecological Use	Fish Consumption Use	Recreation Use	Other Use
-------	--------------	--------------------	----------------------	-----------------	-----------------------	--------------------	----------------	----------------------	----------------	-----------

No data records returned

Air Quality Nonattainment Areas

Pollutant	Within Nonattainment Status Area?	Nonattainment Status Applicable Standard(s)	Within Maintenance Status Area?	Maintenance Status Applicable Standard(s)
-----------	-----------------------------------	---	---------------------------------	---

No data records returned

Pollutants

Toxics Release Inventory History of Reported Chemicals Released or Transferred in Pounds per Year at Site

TRI Facility ID	Year	Air Emissions	Surface Water Discharges	Off-Site Transfers to POTWs (Publicly Owned Treatment Works)	Underground Injections	Disposal to Land	Total On-Site Releases	Total Off-Site Transfers
-----------------	------	---------------	--------------------------	--	------------------------	------------------	------------------------	--------------------------

No data records returned

Toxics Release Inventory Total Releases and Transfers in Pounds by Chemical and Year

Chemical Name

No data records returned

Community

Environmental Justice

This section shows indexes from EJScreen, EPA's screening tool for environmental justice (EJ) concerns. EPA uses these indexes to identify geographic areas that may warrant further consideration or analysis for potential EJ concerns. Use of these indexes does not designate an area as an "EJ community" or "EJ facility." EJScreen provides screening level indicators, not a determination of the existence or absence of EJ concerns. For more information, see the EJScreen home page.



Potential Environmental Justice Concerns

US Territory

Supplemental/EJ index percentiles >= 90 (Census block group)

Supplemental/EJ index percentiles >= 90 (1-mile average)

EJScreen Indexes Shown

Index Type

Supplemental (default)

Related Reports

EJScreen Community Report

Download Data

Census Block Group ID: 720291002003	US (Percentile)			State (Percentile)		
	Supplemental Indexes	Facility Census Block Group	1-mile Avg	1-mile Max	Facility Census Block Group	1-mile Avg
Count of Indexes At or Above 90th Percentile	7	3	7	4	0	4
Particulate Matter 2.5	--	N/A	--	--	N/A	--
Ozone	--	N/A	--	--	N/A	--
Diesel Particulate Matter	5	3	9	52	24	56
Air Toxics Cancer Risk	54	33	57	79	0	96
Air Toxics Respiratory Hazard Index	37	31	43	79	30	96
Toxic Releases to Air	99	97	99	96	66	99
Traffic Proximity	99	94	99	96	56	96
Lead Paint	99	56	99	94	23	94
Risk Management Plan (RMP) Facility Proximity	76	57	86	25	15	38
Hazardous Waste Proximity	97	84	99	72	41	92
Superfund Proximity	97	89	99	44	29	44
Underground Storage Tanks (UST)	99	82	99	92	62	94
Wastewater Discharge	99	93	99	70	39	75

Map Display Based on: US State

Display Map Layer

Summary - Number of Indexes

○ Facility 1-mile Radius □ Facility Census Block Group



Demographic Profile of Surrounding Area (1-Mile Radius)

This section provides demographic information regarding the community surrounding the facility. ECHO compliance data alone are not sufficient to determine whether violations at a particular facility had negative impacts on public health or the environment. Statistics are based upon the 2021 American Community Survey (ACS) 5-year Summary and are accurate to the extent that the facility latitude and longitude listed below are correct. Census boundaries and demographic data for U.S. Territories are based on the "2020 Island Areas Demographic Profiles" from the U.S. Census Bureau. EPA's spatial processing methodology considers the overlap between the selected radii and ACS census block groups in determining the demographics surrounding the facility. For more detail about this methodology, see the DFR Data Dictionary <<https://epa.gov/help/reports/dfr-data-dictionary#demographic>>.

General Statistics (ACS (American Community Survey))		Age Breakdown (ACS (American Community Survey)) - Persons (%)	
Total Persons	8,308	Children 5 years and younger	299 (4%)
Population Density	2,709/sq.mi.	Minors 17 years and younger	1,612 (19%)
Housing Units in Area	3,413	Adults 18 years and older	6,698 (81%)
Percent People of Color	100%	Seniors 65 years and older	1,334 (16%)
Households in Area	2,878		
Households on Public Assistance	113	Race Breakdown (ACS (American Community Survey)) - Persons (%)	
Persons With Low Income	4,969	White	2,986 (36%)
Percent With Low Income	60%	African-American	0 (0%)
		Hispanic-Origin	8,281 (100%)
		Asian	23 (0%)

Geography	
Radius of Selected Area	1 mi.
Center Latitude	18.379343
Center Longitude	-65.899218
Land Area	98%
Water Area	2%

Income Breakdown (ACS (American Community Survey)) - Households (%)	
Less than \$15,000	683 (23.76%)
\$15,000 - \$25,000	520 (18.09%)
\$25,000 - \$50,000	766 (26.64%)
\$50,000 - \$75,000	360 (12.52%)
Greater than \$75,000	546 (18.99%)

Race Breakdown (ACS (American Community Survey)) - Persons (%)	
Hawaiian/Pacific Islander	0 (0%)
American Indian	11 (0%)
Other/Multiracial	2,795 (34%)

Education Level (Persons 25 & older) (ACS (American Community Survey)) - Persons (%)	
Less than 9th Grade	630 (10.72%)
9th through 12th Grade	306 (5.2%)
High School Diploma	1,363 (23.18%)
Some College/2-year	746 (12.69%)
B.S./B.A. (Bachelor of Science/Bachelor of Arts) or More	1,940 (33%)



Detailed Facility Report

Facility Summary

CANOVANAS INDIAN CLEANER

100 CALLE CORCHADO, CANOVANAS, PR 00729

FRS (Facility Registry Service) ID: 110005973642

EPA Region: 02

Latitude: 18.37822

Longitude: -65.89894

Locational Data Source: FRS

Industries: Personal and Laundry Services

Indian Country: N

Enforcement and Compliance Summary

Statute	CAA
Compliance Monitoring Activities (5 years)	--
Date of Last Compliance Monitoring Activity	09/12/2013
Compliance Status	No Violation Identified
Qtrs in Noncompliance (of 12)	0
Qtrs with Significant Violation	0
Informal Enforcement Actions (5 years)	--
Formal Enforcement Actions (5 years)	--
Penalties from Formal Enforcement Actions (5 years)	--
EPA Cases (5 years)	--
Penalties from EPA Cases (5 years)	--
Statute	RCRA
Compliance Monitoring Activities (5 years)	--
Date of Last Compliance Monitoring Activity	--
Compliance Status	No Violation Identified
Qtrs in Noncompliance (of 12)	0
Qtrs with Significant Violation	0
Informal Enforcement Actions (5 years)	--
Formal Enforcement Actions (5 years)	--
Penalties from Formal Enforcement Actions (5 years)	--
EPA Cases (5 years)	--
Penalties from EPA Cases (5 years)	--

Regulatory Information

Clean Air Act (CAA): Operating Minor (PR0000007202900015)

Clean Water Act (CWA): No Information

Resource Conservation and Recovery Act (RCRA): Inactive Other, (PRN000021865)

Safe Drinking Water Act (SDWA): No Information

Other Regulatory Reports

Air Emissions Inventory (EIS): No Information

Greenhouse Gas Emissions (eGGRT): No Information

Toxic Releases (TRI): No Information

Compliance and Emissions Data Reporting Interface (CEDRI): No Information

Go To Enforcement/Compliance Details

Known Data Problems <<https://epa.gov/resources/echo-data/known-data-problems>>

Facility/System Characteristics

Facility/System Characteristics

System	Statute	Identifier	Universe	Status	Areas	Permit Expiration Date	Indian Country	Latitude	Longitude
FRS		110005973642					N	18.37822	-65.89894
ICIS-Air	CAA	PR0000007202900015	Minor Emissions	Operating	CAAMACT, CAASIP		N	18.37834	-65.899
RCRAInfo	RCRA	PRN000021865	Other	Inactive ()			N		

Facility Address

System	Statute	Identifier	Facility Name	Facility Address	Facility County
FRS		110005973642	CANOVANAS INDIAN CLEANER	100 CALLE CORCHADO, CANOVANAS, PR 00729	Canóvanas Municipio
ICIS-Air	CAA	PR0000007202900015	CANOVANAS INDIAN CLEANER	CORCHADO STREET #100, CANOVANAS, PR 00929	Canóvanas Municipio
RCRAInfo	RCRA	PRN000021865	CANOVANAS INDIAN LAUNDRY	100 CALLE CORCHADO, CANOVANAS, PR 00756	Canóvanas Municipio

Facility SIC (Standard Industrial Classification) Codes

System	Identifier	SIC Code	SIC Description
ICIS-Air	PR0000007202900015	7216	Drycleaning Plants, Except Rug

Facility NAICS (North American Industry Classification System) Codes

System	Identifier	NAICS Code	NAICS Description
ICIS-Air	PR0000007202900015	812320	Drycleaning and Laundry Services (except Coin-Operated)

Facility Tribe Information

Reservation Name	Tribe Name	EPA Tribal ID	Distance to Tribe (miles)
No data records returned			

Enforcement and Compliance

Compliance Monitoring History Last 5 Years

Statute	Source ID	System	Activity Type	Compliance Monitoring Type	Lead Agency	Date	Finding (if applicable)
No data records returned							

Entries in italics are not included in ECHO's Compliance Monitoring Activity counts because they are not compliance monitoring strategy <<https://www.epa.gov/compliance/compliance-monitoring-programs>> activities or because they are not counted as inspections within EPA's Annual Results <<https://www.epa.gov/enforcement/enforcement-data-and-results>>.

Compliance Summary Data

Statute	Source ID	Current SNC (Significant Noncompliance)/HPV (High Priority Violation)	Current As Of	Qtrs with NC (Noncompliance) (of 12)	Data Last Refreshed
CAA	PR0000007202900015	No	10/19/2024	0	10/18/2024
RCRA	PRN000021865	No	10/19/2024	0	10/18/2024

Three-Year Compliance History by Quarter

Statute	Program/Pollutant/Violation Type	QTR 1	QTR 2	QTR 3	QTR 4	QTR 5	QTR 6	QTR 7	QTR 8	QTR 9	QTR 10	QTR 11	QTR 12+
CAA (Source ID: PR0000007202900015)		10/01-12/31/21	01/01-03/31/22	04/01-06/30/22	07/01-09/30/22	10/01-12/31/22	01/01-03/31/23	04/01-06/30/23	07/01-09/30/23	10/01-12/31/23	01/01-03/31/24	04/01-06/30/24	07/01-09/30/24
	Facility-Level Status	No Violation Identified	No Violation Identified	No Violation Identified	No Violation Identified	No Violation Identified	No Violation Identified	No Violation Identified	No Violation Identified	No Violation Identified	No Violation Identified	No Violation Identified	No Violation Identified
	HPV History												
	Violation Type	Agency	Programs	Pollutants									

Statute	Program/Pollutant/Violation Type	QTR 1	QTR 2	QTR 3	QTR 4	QTR 5	QTR 6	QTR 7	QTR 8	QTR 9	QTR 10	QTR 11	QTR 12+
RCRA (Source ID: PRN000021865)		10/01-12/31/21	01/01-03/31/22	04/01-06/30/22	07/01-09/30/22	10/01-12/31/22	01/01-03/31/23	04/01-06/30/23	07/01-09/30/23	10/01-12/31/23	01/01-03/31/24	04/01-06/30/24	07/01-09/30/24
	Facility-Level Status	No Violation Identified	No Violation Identified	No Violation Identified	No Violation Identified	No Violation Identified	No Violation Identified	No Violation Identified	No Violation Identified	No Violation Identified	No Violation Identified	No Violation Identified	No Violation Identified
	Violation	Agency											

Informal Enforcement Actions Last 5 Years

Statute	System	Source ID	Type of Action	Lead Agency	Date
No data records returned					

Entries in italics are not counted as "informal enforcement actions" in EPA policies pertaining to enforcement response tools.

Formal Enforcement Actions Last 5 Years

Statute	System	Law/Section	Source ID	Type of Action	Case No.	Lead Agency	Case Name	Issued/Filed Date	Settlements/Actions	Settlement/Action Date	Federal Penalty Assessed	State/Local Penalty Assessed	Penalty Amount Collected	SEP Value	Comp Action Cost
No data records returned															

Environmental Conditions

Watersheds

12-Digit WBD (Watershed Boundary Dataset) HUC (RAD (Reach Address Database))	WBD (Watershed Boundary Dataset) Subwatershed Name (RAD (Reach Address Database))	State Water Body Name (ICIS (Integrated Compliance Information System))	Beach Closures Within Last Year	Beach Closures Within Last Two Years	Pollutants Potentially Related to Impairment	Watershed with ESA (Endangered Species Act)-listed Aquatic Species?
--	---	---	---------------------------------	--------------------------------------	--	---

No data records returned

Assessed Waters From Latest State Submission (ATTAINS)

State	Report Cycle	Assessment Unit ID	Assessment Unit Name	Water Condition	Cause Groups Impaired	Drinking Water Use	Ecological Use	Fish Consumption Use	Recreation Use	Other Use
-------	--------------	--------------------	----------------------	-----------------	-----------------------	--------------------	----------------	----------------------	----------------	-----------

No data records returned

Air Quality Nonattainment Areas

Pollutant	Within Nonattainment Status Area?	Nonattainment Status Applicable Standard(s)	Within Maintenance Status Area?	Maintenance Status Applicable Standard(s)
-----------	-----------------------------------	---	---------------------------------	---

No data records returned

Pollutants

Toxics Release Inventory History of Reported Chemicals Released or Transferred in Pounds per Year at Site ⓘ

TRI Facility ID	Year	Air Emissions	Surface Water Discharges	Off-Site Transfers to POTWs (Publicly Owned Treatment Works)	Underground Injections	Disposal to Land	Total On-Site Releases	Total Off-Site Transfers
-----------------	------	---------------	--------------------------	--	------------------------	------------------	------------------------	--------------------------

No data records returned

Toxics Release Inventory Total Releases and Transfers in Pounds by Chemical and Year ⓘ

Chemical Name

No data records returned

Community

Environmental Justice

This section shows indexes from EJScreen, EPA's screening tool for environmental justice (EJ) concerns. EPA uses these indexes to identify geographic areas that may warrant further consideration or analysis for potential EJ concerns. Use of these indexes does not designate an area as an "EJ community" or "EJ facility." EJScreen provides screening level indicators, not a determination of the existence or absence of EJ concerns. For more information, see the EJScreen home page.



Potential Environmental Justice Concerns

- US Territory
- Supplemental/EJ index percentiles >= 90 (Census block group)
- Supplemental/EJ index percentiles >= 90 (1-mile average)

EJScreen Indexes Shown

Index Type ⌵

Related Reports

EJScreen Community Report

[Download Data](#)

Census Block Group ID: 720291002003	US (Percentile)			State (Percentile)		
	Facility Census Block Group	1-mile Avg	1-mile Max	Facility Census Block Group	1-mile Avg	1-mile Max
Count of Indexes At or Above 90th Percentile	7	3	7	4	0	4
Particulate Matter 2.5	--	N/A	--	--	N/A	--
Ozone	--	N/A	--	--	N/A	--
Diesel Particulate Matter	5	3	9	52	25	56
Air Toxics Cancer Risk	54	33	57	79	0	96
Air Toxics Respiratory Hazard Index	37	31	43	79	30	96
Toxic Releases to Air	99	97	99	96	66	99
Traffic Proximity	99	94	99	96	56	96
Lead Paint	99	57	99	94	24	94
Risk Management Plan (RMP) Facility Proximity	76	57	86	25	15	38
Hazardous Waste Proximity	97	84	99	72	42	92
Superfund Proximity	97	88	99	44	29	44
Underground Storage Tanks (UST)	99	82	99	92	62	94
Wastewater Discharge	99	93	99	70	39	75

Map Display Based on: US State

Display Map Layer Summary - Number of Indexes

Facility 1-mile Radius Facility Census Block Group

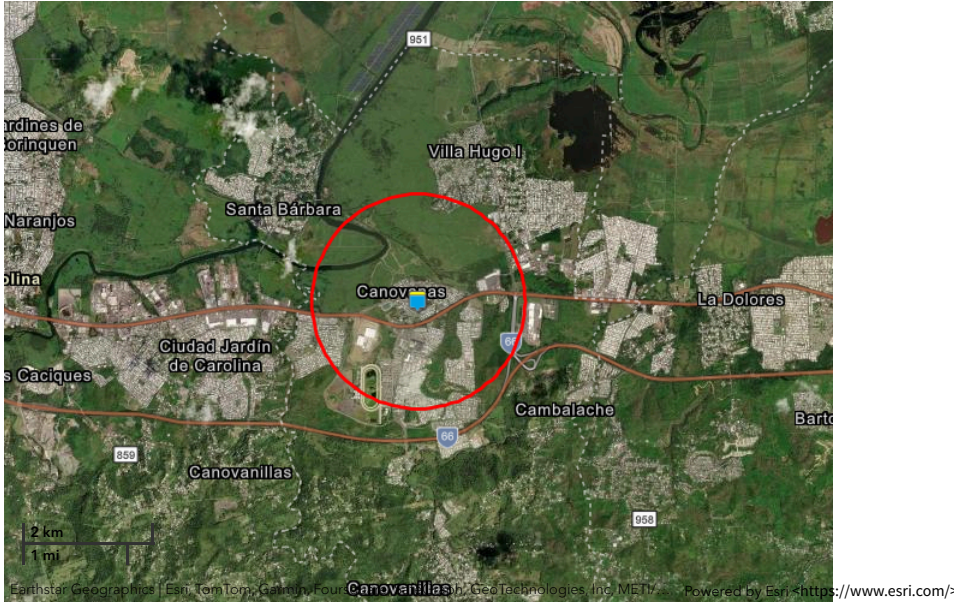

Demographic Profile of Surrounding Area (1-Mile Radius)

This section provides demographic information regarding the community surrounding the facility. ECHO compliance data alone are not sufficient to determine whether violations at a particular facility had negative impacts on public health or the environment. Statistics are based upon the 2021 American Community Survey (ACS) 5-year Summary and are accurate to the extent that the facility latitude and longitude listed below are correct. Census boundaries and demographic data for U.S. Territories are based on the "2020 Island Areas Demographic Profiles" from the U.S. Census Bureau. EPA's spatial processing methodology considers the overlap between the selected radii and ACS census block groups in determining the demographics surrounding the facility. For more detail about this methodology, see the DFR Data Dictionary <https://epa.gov/help/reports/dfr-data-dictionary#demographic>.

General Statistics (ACS (American Community Survey))	
Total Persons	8,658
Population Density	2,819/sq.mi.
Housing Units in Area	3,465
Percent People of Color	100%
Households in Area	2,954
Households on Public Assistance	117
Persons With Low Income	5,006
Percent With Low Income	58%

Geography	
Radius of Selected Area	1 mi.
Center Latitude	18.37822
Center Longitude	-65.89894
Land Area	98%
Water Area	2%

Income Breakdown (ACS (American Community Survey)) - Households (%)	
Less than \$15,000	651 (22.04%)
\$15,000 - \$25,000	502 (16.99%)
\$25,000 - \$50,000	799 (27.05%)
\$50,000 - \$75,000	396 (13.41%)
Greater than \$75,000	606 (20.51%)

Age Breakdown (ACS (American Community Survey)) - Persons (%)	
Children 5 years and younger	320 (4%)
Minors 17 years and younger	1,714 (20%)
Adults 18 years and older	6,943 (80%)
Seniors 65 years and older	1,351 (16%)

Race Breakdown (ACS (American Community Survey)) - Persons (%)	
White	3,190 (37%)
African-American	0 (0%)
Hispanic-Origin	8,630 (100%)
Asian	20 (0%)
Hawaiian/Pacific Islander	0 (0%)
American Indian	12 (0%)
Other/Multiracial	2,828 (33%)

Education Level (Persons 25 & older) (ACS (American Community Survey)) - Persons (%)	
Less than 9th Grade	556 (9.15%)
9th through 12th Grade	302 (4.97%)
High School Diploma	1,372 (22.58%)
Some College/2-year	788 (12.97%)
B.S./B.A. (Bachelor of Science/Bachelor of Arts) or More	2,114 (34.8%)



Detailed Facility Report

Facility Summary

ALUMINUM EXTRUSSION CORP
PR-185 KM 0.65, CANOVANAS, PR 00729
FRS (Facility Registry Service) ID: 110007805688
EPA Region: 02
Latitude: 18.373702
Longitude: -65.899955
Locational Data Source: TRIS
Industries: Fabricated Metal Product Manufacturing
Indian Country: N

Enforcement and Compliance Summary

Statute	RCRA
Compliance Monitoring Activities (5 years)	--
Date of Last Compliance Monitoring Activity	01/21/2004
Compliance Status	No Violation Identified
Qtrs in Noncompliance (of 12)	0
Qtrs with Significant Violation	0
Informal Enforcement Actions (5 years)	--
Formal Enforcement Actions (5 years)	--
Penalties from Formal Enforcement Actions (5 years)	--
EPA Cases (5 years)	--
Penalties from EPA Cases (5 years)	--

Regulatory Information

Clean Air Act (CAA): No Information
Clean Water Act (CWA): No Information
Resource Conservation and Recovery Act (RCRA): Inactive Other, (PRN008011124), Inactive Other, (PRD090000068)
Safe Drinking Water Act (SDWA): No Information

Other Regulatory Reports

Air Emissions Inventory (EIS): No Information
Greenhouse Gas Emissions (eGGRT): No Information
Toxic Releases (TRI): 00629LMNMP185RO
Compliance and Emissions Data Reporting Interface (CEDRI): No Information

Go To Enforcement/Compliance Details
 Known Data Problems <<https://epa.gov/resources/echo-data/known-data-problems>>

Facility/System Characteristics

Facility/System Characteristics

System	Statute	Identifier	Universe	Status	Areas	Permit Expiration Date	Indian Country	Latitude	Longitude
FRS		110007805688					N	18.373702	-65.899955
TRI	EP313	00629LMNMP185RO	Toxics Release Inventory	Last Reported for 1992			N	18.373702	-65.899955
RCRAInfo	RCRA	PRN008011124	Other	Inactive ()			N	18.373702	-65.899955
RCRAInfo	RCRA	PRD090000068	Other	Inactive ()			N	18.373702	-65.899955

Facility Address

System	Statute	Identifier	Facility Name	Facility Address	Facility County
FRS		110007805688	ALUMINUM EXTRUSSION CORP	PR-185 KM 0.65, CANOVANAS, PR 00729	Canóvanas Municipio
TRI	EP313	00629LMNMP185RO	ALUMINUM PROCESSING CORP	185 STATE RD KM 065, CANOVANAS, PR 00729	Canóvanas Municipio

System	Statute	Identifier	Facility Name	Facility Address	Facility County
RCRAInfo	RCRA	PRN008011124	PERFILES DE ALUMINIO	STATE RD 185 KM 0.65, CANOVANAS, PR 00729-1622	Canóvanas Municipio
RCRAInfo	RCRA	PRD090000068	ALUMINUM EXTRUSSION CORP	RD 185 KM 0.65, CANOVANAS, PR 00629	Canóvanas Municipio

Facility SIC (Standard Industrial Classification) Codes

System	Identifier	SIC Code	SIC Description
TRI	00629LMNMP185RO	3354	Aluminum Extruded Products
TRI	00629LMNMP185RO	3471	Plating And Polishing

Facility NAICS (North American Industry Classification System) Codes

System	Identifier	NAICS Code	NAICS Description
TRI	00629LMNMP185RO	332813	Electroplating, Plating, Polishing, Anodizing, and Coloring
RCRAInfo	PRD090000068	331316	Aluminum Extruded Product Manufacturing

Facility Tribe Information

Reservation Name	Tribe Name	EPA Tribal ID	Distance to Tribe (miles)
No data records returned			

Enforcement and Compliance

Compliance Monitoring History Last 5 Years

Statute	Source ID	System	Activity Type	Compliance Monitoring Type	Lead Agency	Date	Finding (if applicable)
No data records returned							

No data records returned

Entries in italics are not included in ECHO's Compliance Monitoring Activity counts because they are not compliance monitoring strategy <https://www.epa.gov/compliance/compliance-monitoring-programs> activities or because they are not counted as inspections within EPA's Annual Results <https://www.epa.gov/enforcement/enforcement-data-and-results>.

Compliance Summary Data

Statute	Source ID	Current SNC (Significant Noncompliance)/HPV (High Priority Violation)	Current As Of	Qtrs with NC (Noncompliance) (of 12)	Data Last Refreshed
RCRA	PRN008011124	No	10/19/2024	0	10/18/2024
RCRA	PRD090000068	No	10/19/2024	0	10/18/2024

Three-Year Compliance History by Quarter

Statute	Program/Pollutant/Violation Type	QTR 1	QTR 2	QTR 3	QTR 4	QTR 5	QTR 6	QTR 7	QTR 8	QTR 9	QTR 10	QTR 11	QTR 12+
RCRA (Source ID: PRD090000068)	Facility-Level Status	No Violation Identified	No Violation Identified	No Violation Identified	No Violation Identified	No Violation Identified	No Violation Identified	No Violation Identified	No Violation Identified	No Violation Identified	No Violation Identified	No Violation Identified	No Violation Identified
	Violation												
	Agency												
RCRA (Source ID: PRN008011124)	Facility-Level Status	No Violation Identified	No Violation Identified	No Violation Identified	No Violation Identified	No Violation Identified	No Violation Identified	No Violation Identified	No Violation Identified	No Violation Identified	No Violation Identified	No Violation Identified	No Violation Identified
	Violation												
	Agency												

Informal Enforcement Actions Last 5 Years

Statute	System	Source ID	Type of Action	Lead Agency	Date
No data records returned					

No data records returned

Entries in italics are not counted as "informal enforcement actions" in EPA policies pertaining to enforcement response tools.

Formal Enforcement Actions Last 5 Years

Statute	System	Law/Section	Source ID	Type of Action	Case No.	Lead Agency	Case Name	Issued/ Filed Date	Settlements/ Actions	Settlement/ Action Date	Federal Penalty Assessed	State/ Local Penalty Assessed	Penalty Amount Collected	SEP Value	Comp Action Cost
No data records returned															

No data records returned

Environmental Conditions

Watersheds

12-Digit WBD (Watershed Boundary Dataset) HUC (RAD (Reach Address Database))	WBD (Watershed Boundary Dataset) Subwatershed Name (RAD (Reach Address Database))	State Water Body Name (ICIS (Integrated Compliance Information System))	Beach Closures Within Last Year	Beach Closures Within Last Two Years	Pollutants Potentially Related to Impairment	Watershed with ESA (Endangered Species Act)-listed Aquatic Species?
No data records returned						

No data records returned

Assessed Waters From Latest State Submission (ATTAINS)

State	Report Cycle	Assessment Unit ID	Assessment Unit Name	Water Condition	Cause Groups Impaired	Drinking Water Use	Ecological Use	Fish Consumption Use	Recreation Use	Other Use
No data records returned										

No data records returned

Air Quality Nonattainment Areas

Pollutant	Within Nonattainment Status Area?	Nonattainment Status Applicable Standard(s)	Within Maintenance Status Area?	Maintenance Status Applicable Standard(s)
No data records returned				

Pollutants

Toxics Release Inventory History of Reported Chemicals Released or Transferred in Pounds per Year at Site

TRI Facility ID	Year	Air Emissions	Surface Water Discharges	Off-Site Transfers to POTWs (Publicly Owned Treatment Works)	Underground Injections	Disposal to Land	Total On-Site Releases	Total Off-Site Transfers
No data records returned								

Toxics Release Inventory Total Releases and Transfers in Pounds by Chemical and Year

Chemical Name
No data records returned

Community

Environmental Justice

This section shows indexes from EJScreen, EPA's screening tool for environmental justice (EJ) concerns. EPA uses these indexes to identify geographic areas that may warrant further consideration or analysis for potential EJ concerns. Use of these indexes does not designate an area as an "EJ community" or "EJ facility." EJScreen provides screening level indicators, not a determination of the existence or absence of EJ concerns. For more information, see the EJScreen home page.



Potential Environmental Justice Concerns

US Territory

Supplemental/EJ index percentiles >= 90 (1-mile average)

EJScreen Indexes Shown

Index Type

Related Reports

EJScreen Community Report

[Download Data](#)

Supplemental Indexes	US (Percentile)			State (Percentile)		
	Facility Census Block Group	1-mile Avg	1-mile Max	Facility Census Block Group	1-mile Avg	1-mile Max
Count of Indexes At or Above 90th Percentile	0	3	7	0	0	4
Particulate Matter 2.5	--	N/A	--	--	N/A	--
Ozone	--	N/A	--	--	N/A	--
Diesel Particulate Matter	0	4	9	10	26	56
Air Toxics Cancer Risk	47	33	57	21	0	96
Air Toxics Respiratory Hazard Index	29	31	43	23	29	96
Toxic Releases to Air	89	97	99	42	65	99
Traffic Proximity	81	94	99	32	54	96
Lead Paint	43	53	99	20	22	94
Risk Management Plan (RMP) Facility Proximity	49	57	86	12	15	38
Hazardous Waste Proximity	71	85	99	24	42	92
Superfund Proximity	84	88	99	28	29	44
Underground Storage Tanks (UST)	76	76	99	62	61	94
Wastewater Discharge	89	92	99	36	38	75

Map Display Based on: US State

Display Map Layer

Facility 1-mile Radius Facility Census Block Group



Demographic Profile of Surrounding Area (1-Mile Radius)

This section provides demographic information regarding the community surrounding the facility. ECHO compliance data alone are not sufficient to determine whether violations at a particular facility had negative impacts on public health or the environment. Statistics are based upon the 2021 American Community Survey (ACS) 5-year Summary and are accurate to the extent that the facility latitude and longitude listed below are correct. Census boundaries and demographic data for U.S. Territories are based on the "2020 Island Areas Demographic Profiles" from the U.S. Census Bureau. EPA's spatial processing methodology considers the overlap between the selected radii and ACS census block groups in determining the demographics surrounding the facility. For more detail about this methodology, see the DFR Data Dictionary <<https://epa.gov/help/reports/dfr-data-dictionary#demographic>>.

General Statistics (ACS (American Community Survey))

Total Persons	10,085
Population Density	3,271/sq.mi.
Housing Units in Area	3,804
Percent People of Color	100%
Households in Area	3,311
Households on Public Assistance	118
Persons With Low Income	5,450
Percent With Low Income	54%

Geography

Radius of Selected Area	1 mi.
Center Latitude	18.373702
Center Longitude	-65.899955
Land Area	99%
Water Area	1%

Income Breakdown (ACS (American Community Survey)) - Households (%)

Less than \$15,000	589 (17.79%)
\$15,000 - \$25,000	501 (15.14%)
\$25,000 - \$50,000	947 (28.61%)
\$50,000 - \$75,000	516 (15.59%)
Greater than \$75,000	757 (22.87%)

Age Breakdown (ACS (American Community Survey)) - Persons (%)

Children 5 years and younger	395 (4%)
Minors 17 years and younger	1,976 (20%)
Adults 18 years and older	8,107 (80%)
Seniors 65 years and older	1,568 (16%)

Race Breakdown (ACS (American Community Survey)) - Persons (%)

White	3,890 (39%)
African-American	0 (0%)
Hispanic-Origin	10,057 (100%)
Asian	18 (0%)
Hawaiian/Pacific Islander	0 (0%)
American Indian	13 (0%)
Other/Multiracial	3,061 (30%)

Education Level (Persons 25 & older) (ACS (American Community Survey)) - Persons (%)

Less than 9th Grade	444 (6.27%)
9th through 12th Grade	314 (4.44%)
High School Diploma	1,571 (22.2%)
Some College/2-year	954 (13.48%)
B.S./B.A. (Bachelor of Science/Bachelor of Arts) or More	2,675 (37.8%)



Detailed Facility Report

Facility Summary

ALUMINUM EXTRUSSION CORP
PR-185 KM 0.65, CANOVANAS, PR 00729
FRS (Facility Registry Service) ID: 110007805688
EPA Region: 02
Latitude: 18.373702
Longitude: -65.899955
Locational Data Source: TRIS
Industries: Fabricated Metal Product Manufacturing
Indian Country: N

Enforcement and Compliance Summary

Statute	RCRA
Compliance Monitoring Activities (5 years)	--
Date of Last Compliance Monitoring Activity	01/21/2004
Compliance Status	No Violation Identified
Qtrs in Noncompliance (of 12)	0
Qtrs with Significant Violation	0
Informal Enforcement Actions (5 years)	--
Formal Enforcement Actions (5 years)	--
Penalties from Formal Enforcement Actions (5 years)	--
EPA Cases (5 years)	--
Penalties from EPA Cases (5 years)	--

Regulatory Information

Clean Air Act (CAA): No Information
Clean Water Act (CWA): No Information
Resource Conservation and Recovery Act (RCRA): Inactive Other, (PRN008011124), Inactive Other, (PRD090000068)
Safe Drinking Water Act (SDWA): No Information

Other Regulatory Reports

Air Emissions Inventory (EIS): No Information
Greenhouse Gas Emissions (eGGR): No Information
Toxic Releases (TRI): 00629LMNMP185RO
Compliance and Emissions Data Reporting Interface (CEDRI): No Information

Go To Enforcement/Compliance Details
 Known Data Problems <<https://epa.gov/resources/echo-data/known-data-problems>>

Facility/System Characteristics

Facility/System Characteristics

System	Statute	Identifier	Universe	Status	Areas	Permit Expiration Date	Indian Country	Latitude	Longitude
FRS		110007805688					N	18.373702	-65.899955
TRI	EP313	00629LMNMP185RO	Toxics Release Inventory	Last Reported for 1992			N	18.373702	-65.899955
RCRAInfo	RCRA	PRN008011124	Other	Inactive ()			N	18.373702	-65.899955
RCRAInfo	RCRA	PRD090000068	Other	Inactive ()			N	18.373702	-65.899955

Facility Address

System	Statute	Identifier	Facility Name	Facility Address	Facility County
FRS		110007805688	ALUMINUM EXTRUSSION CORP	PR-185 KM 0.65, CANOVANAS, PR 00729	Canóvanas Municipio
TRI	EP313	00629LMNMP185RO	ALUMINUM PROCESSING CORP	185 STATE RD KM 065, CANOVANAS, PR 00729	Canóvanas Municipio

System	Statute	Identifier	Facility Name	Facility Address	Facility County
RCRAInfo	RCRA	PRN008011124	PERFILES DE ALUMINIO	STATE RD 185 KM 0.65, CANOVANAS, PR 00729-1622	Canóvanas Municipio
RCRAInfo	RCRA	PRD090000068	ALUMINUM EXTRUSSION CORP	RD 185 KM 0.65, CANOVANAS, PR 00629	Canóvanas Municipio

Facility SIC (Standard Industrial Classification) Codes

System	Identifier	SIC Code	SIC Description
TRI	00629LMNMP185RO	3354	Aluminum Extruded Products
TRI	00629LMNMP185RO	3471	Plating And Polishing

Facility NAICS (North American Industry Classification System) Codes

System	Identifier	NAICS Code	NAICS Description
TRI	00629LMNMP185RO	332813	Electroplating, Plating, Polishing, Anodizing, and Coloring
RCRAInfo	PRD090000068	331316	Aluminum Extruded Product Manufacturing

Facility Tribe Information

Reservation Name	Tribe Name	EPA Tribal ID	Distance to Tribe (miles)
No data records returned			

Enforcement and Compliance

Compliance Monitoring History Last 5 Years

Statute	Source ID	System	Activity Type	Compliance Monitoring Type	Lead Agency	Date	Finding (if applicable)
No data records returned							

No data records returned

Entries in italics are not included in ECHO's Compliance Monitoring Activity counts because they are not compliance monitoring strategy <https://www.epa.gov/compliance/compliance-monitoring-programs> activities or because they are not counted as inspections within EPA's Annual Results <https://www.epa.gov/enforcement/enforcement-data-and-results>.

Compliance Summary Data

Statute	Source ID	Current SNC (Significant Noncompliance)/HPV (High Priority Violation)	Current As Of	Qtrs with NC (Noncompliance) (of 12)	Data Last Refreshed
RCRA	PRN008011124	No	10/19/2024	0	10/18/2024
RCRA	PRD090000068	No	10/19/2024	0	10/18/2024

Three-Year Compliance History by Quarter

Statute	Program/Pollutant/Violation Type	QTR 1	QTR 2	QTR 3	QTR 4	QTR 5	QTR 6	QTR 7	QTR 8	QTR 9	QTR 10	QTR 11	QTR 12+
RCRA (Source ID: PRD090000068)	Facility-Level Status	No Violation Identified	No Violation Identified	No Violation Identified	No Violation Identified	No Violation Identified	No Violation Identified	No Violation Identified	No Violation Identified	No Violation Identified	No Violation Identified	No Violation Identified	No Violation Identified
	Violation												
	Agency												
RCRA (Source ID: PRN008011124)	Facility-Level Status	No Violation Identified	No Violation Identified	No Violation Identified	No Violation Identified	No Violation Identified	No Violation Identified	No Violation Identified	No Violation Identified	No Violation Identified	No Violation Identified	No Violation Identified	No Violation Identified
	Violation												
	Agency												

Informal Enforcement Actions Last 5 Years

Statute	System	Source ID	Type of Action	Lead Agency	Date
No data records returned					

No data records returned

Entries in italics are not counted as "informal enforcement actions" in EPA policies pertaining to enforcement response tools.

Formal Enforcement Actions Last 5 Years

Statute	System	Law/Section	Source ID	Type of Action	Case No.	Lead Agency	Case Name	Issued/ Filed Date	Settlements/ Actions	Settlement/ Action Date	Federal Penalty Assessed	State/ Local Penalty Assessed	Penalty Amount Collected	SEP Value	Comp Action Cost
No data records returned															

No data records returned

Environmental Conditions

Watersheds

12-Digit WBD (Watershed Boundary Dataset) HUC (RAD (Reach Address Database))	WBD (Watershed Boundary Dataset) Subwatershed Name (RAD (Reach Address Database))	State Water Body Name (ICIS (Integrated Compliance Information System))	Beach Closures Within Last Year	Beach Closures Within Last Two Years	Pollutants Potentially Related to Impairment	Watershed with ESA (Endangered Species Act)-listed Aquatic Species?
No data records returned						

No data records returned

Assessed Waters From Latest State Submission (ATTAINS)

State	Report Cycle	Assessment Unit ID	Assessment Unit Name	Water Condition	Cause Groups Impaired	Drinking Water Use	Ecological Use	Fish Consumption Use	Recreation Use	Other Use
No data records returned										

No data records returned

Air Quality Nonattainment Areas

Pollutant	Within Nonattainment Status Area?	Nonattainment Status Applicable Standard(s)	Within Maintenance Status Area?	Maintenance Status Applicable Standard(s)
No data records returned				

Pollutants

Toxics Release Inventory History of Reported Chemicals Released or Transferred in Pounds per Year at Site

TRI Facility ID	Year	Air Emissions	Surface Water Discharges	Off-Site Transfers to POTWs (Publicly Owned Treatment Works)	Underground Injections	Disposal to Land	Total On-Site Releases	Total Off-Site Transfers
No data records returned								

Toxics Release Inventory Total Releases and Transfers in Pounds by Chemical and Year

Chemical Name
No data records returned

Community

Environmental Justice

This section shows indexes from EJScreen, EPA's screening tool for environmental justice (EJ) concerns. EPA uses these indexes to identify geographic areas that may warrant further consideration or analysis for potential EJ concerns. Use of these indexes does not designate an area as an "EJ community" or "EJ facility." EJScreen provides screening level indicators, not a determination of the existence or absence of EJ concerns. For more information, see the EJScreen home page.



Potential Environmental Justice Concerns

US Territory

Supplemental/EJ index percentiles >= 90 (1-mile average)

EJScreen Indexes Shown

Index Type

Related Reports

EJScreen Community Report

[Download Data](#)

Supplemental Indexes	US (Percentile)			State (Percentile)		
	Facility Census Block Group	1-mile Avg	1-mile Max	Facility Census Block Group	1-mile Avg	1-mile Max
Count of Indexes At or Above 90th Percentile	0	3	7	0	0	4
Particulate Matter 2.5	--	N/A	--	--	N/A	--
Ozone	--	N/A	--	--	N/A	--
Diesel Particulate Matter	0	4	9	10	26	56
Air Toxics Cancer Risk	47	33	57	21	0	96
Air Toxics Respiratory Hazard Index	29	31	43	23	29	96
Toxic Releases to Air	89	97	99	42	65	99
Traffic Proximity	81	94	99	32	54	96
Lead Paint	43	53	99	20	22	94
Risk Management Plan (RMP) Facility Proximity	49	57	86	12	15	38
Hazardous Waste Proximity	71	85	99	24	42	92
Superfund Proximity	84	88	99	28	29	44
Underground Storage Tanks (UST)	76	76	99	62	61	94
Wastewater Discharge	89	92	99	36	38	75

Map Display Based on: US State

Display Map Layer

Facility 1-mile Radius Facility Census Block Group

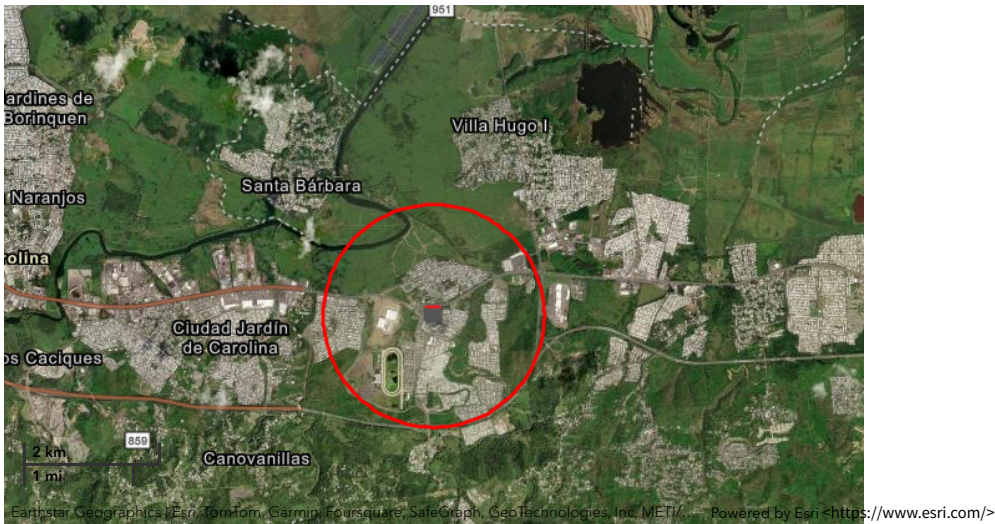

Demographic Profile of Surrounding Area (1-Mile Radius)

This section provides demographic information regarding the community surrounding the facility. ECHO compliance data alone are not sufficient to determine whether violations at a particular facility had negative impacts on public health or the environment. Statistics are based upon the 2021 American Community Survey (ACS) 5-year Summary and are accurate to the extent that the facility latitude and longitude listed below are correct. Census boundaries and demographic data for U.S. Territories are based on the "2020 Island Areas Demographic Profiles" from the U.S. Census Bureau. EPA's spatial processing methodology considers the overlap between the selected radii and ACS census block groups in determining the demographics surrounding the facility. For more detail about this methodology, see the DFR Data Dictionary <<https://epa.gov/help/reports/dfr-data-dictionary#demographic>>.

General Statistics (ACS (American Community Survey))

Total Persons	10,085
Population Density	3,271/sq.mi.
Housing Units in Area	3,804
Percent People of Color	100%
Households in Area	3,311
Households on Public Assistance	118
Persons With Low Income	5,450
Percent With Low Income	54%

Geography

Radius of Selected Area	1 mi.
Center Latitude	18.373702
Center Longitude	-65.899955
Land Area	99%
Water Area	1%

Income Breakdown (ACS (American Community Survey)) - Households (%)

Less than \$15,000	589 (17.79%)
\$15,000 - \$25,000	501 (15.14%)
\$25,000 - \$50,000	947 (28.61%)
\$50,000 - \$75,000	516 (15.59%)
Greater than \$75,000	757 (22.87%)

Age Breakdown (ACS (American Community Survey)) - Persons (%)

Children 5 years and younger	395 (4%)
Minors 17 years and younger	1,976 (20%)
Adults 18 years and older	8,107 (80%)
Seniors 65 years and older	1,568 (16%)

Race Breakdown (ACS (American Community Survey)) - Persons (%)

White	3,890 (39%)
African-American	0 (0%)
Hispanic-Origin	10,057 (100%)
Asian	18 (0%)
Hawaiian/Pacific Islander	0 (0%)
American Indian	13 (0%)
Other/Multiracial	3,061 (30%)

Education Level (Persons 25 & older) (ACS (American Community Survey)) - Persons (%)

Less than 9th Grade	444 (6.27%)
9th through 12th Grade	314 (4.44%)
High School Diploma	1,571 (22.2%)
Some College/2-year	954 (13.48%)
B.S./B.A. (Bachelor of Science/Bachelor of Arts) or More	2,675 (37.8%)



Detailed Facility Report

Facility Summary

AMERICAN PROPERTIES CORP

PR-874 KM 1.1, CANOVANAS, PR 00729

FRS (Facility Registry Service) ID: 110007810495

EPA Region: 02

Latitude: 18.373481

Longitude: -65.900869

Locational Data Source: RCRAINFO

Industries: --

Indian Country: N

Enforcement and Compliance Summary

Statute	RCRA
Compliance Monitoring Activities (5 years)	--
Date of Last Compliance Monitoring Activity	12/22/1998
Compliance Status	No Violation Identified
Qtrs in Noncompliance (of 12)	0
Qtrs with Significant Violation	0
Informal Enforcement Actions (5 years)	--
Formal Enforcement Actions (5 years)	--
Penalties from Formal Enforcement Actions (5 years)	--
EPA Cases (5 years)	--
Penalties from EPA Cases (5 years)	--

Regulatory Information

Clean Air Act (CAA): No Information

Clean Water Act (CWA): No Information

Resource Conservation and Recovery Act (RCRA): Inactive Other, (PRD987369675)

Safe Drinking Water Act (SDWA): No Information

Go To Enforcement/Compliance Details

Known Data Problems <<https://epa.gov/resources/echo-data/known-data-problems>>

Other Regulatory Reports

Air Emissions Inventory (EIS): No Information

Greenhouse Gas Emissions (eGGRT): No Information

Toxic Releases (TRI): No Information

Compliance and Emissions Data Reporting Interface (CEDRI): No Information

Facility/System Characteristics

Facility/System Characteristics

System	Statute	Identifier	Universe	Status	Areas	Permit Expiration Date	Indian Country	Latitude	Longitude
FRS		110007810495					N	18.373481	-65.900869
RCRAInfo	RCRA	PRD987369675	Other	Inactive ()			N	18.373481	-65.900869

Facility Address

System	Statute	Identifier	Facility Name	Facility Address	Facility County
FRS		110007810495	AMERICAN PROPERTIES CORP	PR-874 KM 1.1, CANOVANAS, PR 00729	Canóvanas Municipio
RCRAInfo	RCRA	PRD987369675	AMERICAN PROPERTIES CORP	STATE RD 874 KM 1.1, CANOVANAS, PR 00629	Canóvanas Municipio

Facility SIC (Standard Industrial

Facility NAICS (North American Industry

Classification) Codes

System	Identifier	SIC Code	SIC Description
No data records returned			

Classification System) Codes

System	Identifier	NAICS Code	NAICS Description
No data records returned			

Facility Tribe Information

Reservation Name	Tribe Name	EPA Tribal ID	Distance to Tribe (miles)
No data records returned			

Enforcement and Compliance

Compliance Monitoring History Last 5 Years

Statute	Source ID	System	Activity Type	Compliance Monitoring Type	Lead Agency	Date	Finding (if applicable)
No data records returned							

Entries in italics are not included in ECHO's Compliance Monitoring Activity counts because they are not compliance monitoring strategy <<https://www.epa.gov/compliance/compliance-monitoring-programs>> activities or because they are not counted as inspections within EPA's Annual Results <<https://www.epa.gov/enforcement/enforcement-data-and-results>>.

Compliance Summary Data

Statute	Source ID	Current SNC (Significant Noncompliance)/HPV (High Priority Violation)	Current As Of	Qtrs with NC (Noncompliance) (of 12)	Data Last Refreshed
RCRA	PRD987369675	No	10/19/2024	0	10/18/2024

Three-Year Compliance History by Quarter

Statute	Program/Pollutant/Violation Type	QTR 1	QTR 2	QTR 3	QTR 4	QTR 5	QTR 6	QTR 7	QTR 8	QTR 9	QTR 10	QTR 11	QTR 12+
RCRA (Source ID: PRD987369675)		10/01-12/31/21	01/01-03/31/22	04/01-06/30/22	07/01-09/30/22	10/01-12/31/22	01/01-03/31/23	04/01-06/30/23	07/01-09/30/23	10/01-12/31/23	01/01-03/31/24	04/01-06/30/24	07/01-09/30/24
	Facility-Level Status	No Violation Identified	No Violation Identified	No Violation Identified	No Violation Identified	No Violation Identified	No Violation Identified	No Violation Identified	No Violation Identified	No Violation Identified	No Violation Identified	No Violation Identified	No Violation Identified
	Violation												
	Agency												

Informal Enforcement Actions Last 5 Years

Statute	System	Source ID	Type of Action	Lead Agency	Date
No data records returned					

Entries in italics are not counted as "informal enforcement actions" in EPA policies pertaining to enforcement response tools.

Formal Enforcement Actions Last 5 Years

Statute	System	Law/Section	Source ID	Type of Action	Case No.	Lead Agency	Case Name	Issued/ Filed Date	Settlements/ Actions	Settlement/ Action Date	Federal Penalty Assessed	State/ Local Penalty Assessed	Penalty Amount Collected	SEP Value	Comp Action Cost
No data records returned															

Environmental Conditions

Watersheds

12-Digit WBD (Watershed Boundary Dataset) HUC (RAD (Reach Address Database))	WBD (Watershed Boundary Dataset) Subwatershed Name (RAD (Reach Address Database))	State Water Body Name (ICIS (Integrated Compliance Information System))	Beach Closures Within Last Year	Beach Closures Within Last Two Years	Pollutants Potentially Related to Impairment	Watershed with ESA (Endangered Species Act)-listed Aquatic Species?
No data records returned						

Assessed Waters From Latest State Submission (ATTAINS)

State	Report Cycle	Assessment Unit ID	Assessment Unit Name	Water Condition	Cause Groups Impaired	Drinking Water Use	Ecological Use	Fish Consumption Use	Recreation Use	Other Use
No data records returned										

Air Quality Nonattainment Areas

Pollutant	Within Nonattainment Status Area?	Nonattainment Status Applicable Standard(s)	Within Maintenance Status Area?	Maintenance Status Applicable Standard(s)
No data records returned				

Pollutants

Toxics Release Inventory History of Reported Chemicals Released or Transferred in Pounds per

Year at Site ⓘ

TRI Facility ID | Year | Air Emissions | Surface Water Discharges | Off-Site Transfers to POTWs (Publicly Owned Treatment Works) | Underground Injections | Disposal to Land | Total On-Site Releases | Total Off-Site Transfers

No data records returned

Toxics Release Inventory Total Releases and Transfers in Pounds by Chemical and Year ⓘ

Chemical Name

No data records returned

Community

Environmental Justice

This section shows indexes from EJScreen, EPA's screening tool for environmental justice (EJ) concerns. EPA uses these indexes to identify geographic areas that may warrant further consideration or analysis for potential EJ concerns. Use of these indexes does not designate an area as an "EJ community" or "EJ facility." EJScreen provides screening level indicators, not a determination of the existence or absence of EJ concerns. For more information, see the EJScreen home page.



Potential Environmental Justice Concerns

US Territory

Supplemental/EJ index percentiles >= 90 (1-mile average)

EJScreen Indexes Shown

Index Type

Supplemental (default) ⌵

Related Reports

EJScreen Community Report

[Download Data](#)

Supplemental Indexes	US (Percentile)			State (Percentile)		
	Facility Census Block Group	1-mile Avg	1-mile Max	Facility Census Block Group	1-mile Avg	1-mile Max
Count of Indexes At or Above 90th Percentile	0	3	7	0	0	4
Particulate Matter 2.5	--	N/A	--	--	N/A	--
Ozone	--	N/A	--	--	N/A	--
Diesel Particulate Matter	0	4	9	10	27	56
Air Toxics Cancer Risk	47	33	57	21	0	ⓘ 96
Air Toxics Respiratory Hazard Index	29	31	43	23	29	ⓘ 96
Toxic Releases to Air	89	ⓘ 97	ⓘ 99	42	65	ⓘ 99
Traffic Proximity	81	ⓘ 94	ⓘ 99	32	54	ⓘ 96
Lead Paint	43	52	ⓘ 99	20	22	ⓘ 94
Risk Management Plan (RMP) Facility Proximity	49	58	86	12	15	38
Hazardous Waste Proximity	71	85	ⓘ 99	24	43	ⓘ 92
Superfund Proximity	84	88	ⓘ 99	28	30	44
Underground Storage Tanks (UST)	76	75	ⓘ 99	62	61	ⓘ 94
Wastewater Discharge	89	ⓘ 92	ⓘ 99	36	38	75

Map Display Based on: US State

Display Map Layer

Summary - Number of Indexes ⌵

Facility 1-mile Radius Facility Census Block Group



Demographic Profile of Surrounding Area (1-Mile Radius)

This section provides demographic information regarding the community surrounding the facility. ECHO compliance data alone are not sufficient to determine whether violations at a particular facility had negative impacts on public health or the environment. Statistics are based upon the 2021 American Community Survey (ACS) 5-year Summary and are accurate to the extent that the facility latitude and longitude listed below are correct. Census boundaries and demographic data for U.S. Territories are based on the "2020 Island Areas Demographic Profiles" from the U.S. Census Bureau. EPA's spatial processing methodology considers the overlap between the selected radii and ACS census block groups in determining the demographics surrounding the facility. For more detail about this methodology, see the DFR Data Dictionary <<https://epa.gov/help/reports/dfr-data-dictionary#demographic>>.

General Statistics (ACS (American Community Survey))

Total Persons	10,395
Population Density	3,373/sq.mi.
Housing Units in Area	3,929
Percent People of Color	100%
Households in Area	3,411
Households on Public Assistance	120
Persons With Low Income	5,727
Percent With Low Income	55%

Geography

Radius of Selected Area	1 mi.
Center Latitude	18.373481
Center Longitude	-65.900869
Land Area	99%
Water Area	1%

Income Breakdown (ACS (American Community Survey)) - Households (%)

Less than \$15,000	610 (17.88%)
\$15,000 - \$25,000	529 (15.5%)
\$25,000 - \$50,000	995 (29.16%)
\$50,000 - \$75,000	527 (15.45%)
Greater than \$75,000	751 (22.01%)

Age Breakdown (ACS (American Community Survey)) - Persons (%)

Children 5 years and younger	401 (4%)
Minors 17 years and younger	2,002 (19%)
Adults 18 years and older	8,394 (81%)
Seniors 65 years and older	1,656 (16%)

Race Breakdown (ACS (American Community Survey)) - Persons (%)

White	3,967 (38%)
African-American	0 (0%)
Hispanic-Origin	10,367 (100%)
Asian	15 (0%)
Hawaiian/Pacific Islander	0 (0%)
American Indian	11 (0%)
Other/Multiracial	3,170 (31%)

Education Level (Persons 25 & older) (ACS (American Community Survey)) - Persons (%)

Less than 9th Grade	458 (6.24%)
9th through 12th Grade	334 (4.55%)
High School Diploma	1,675 (22.81%)
Some College/2-year	990 (13.48%)
B.S./B.A. (Bachelor of Science/Bachelor of Arts) or More	2,730 (37.17%)



Detailed Facility Report

Facility Summary

BRISAS DE LOIZA STP

PR-874 KM 7.1, CANOVANAS, PR 00729

FRS (Facility Registry Service) ID: 110007803939

EPA Region: 02

Latitude: 18.373688

Longitude: -65.901655

Locational Data Source: RCRAINFO

Industries: Utilities

Indian Country: N

Enforcement and Compliance Summary

Statute	RCRA
Compliance Monitoring Activities (5 years)	--
Date of Last Compliance Monitoring Activity	--
Compliance Status	No Violation Identified
Qtrs in Noncompliance (of 12)	0
Qtrs with Significant Violation	0
Informal Enforcement Actions (5 years)	--
Formal Enforcement Actions (5 years)	--
Penalties from Formal Enforcement Actions (5 years)	--
EPA Cases (5 years)	--
Penalties from EPA Cases (5 years)	--

Regulatory Information

Clean Air Act (CAA): No Information

Clean Water Act (CWA): No Information

Resource Conservation and Recovery Act (RCRA): Inactive Other, (PRD000689331)

Safe Drinking Water Act (SDWA): No Information

Go To Enforcement/Compliance Details

Known Data Problems <<https://epa.gov/resources/echo-data/known-data-problems>>

Other Regulatory Reports

Air Emissions Inventory (EIS): No Information

Greenhouse Gas Emissions (eGGRT): No Information

Toxic Releases (TRI): No Information

Compliance and Emissions Data Reporting Interface (CEDRI): No Information

Facility/System Characteristics

Facility/System Characteristics

System	Statute	Identifier	Universe	Status	Areas	Permit Expiration Date	Indian Country	Latitude	Longitude
FRS		110007803939					N	18.373688	-65.901655
RCRAInfo	RCRA	PRD000689331	Other	Inactive ()			N	18.373688	-65.901655

Facility Address

System	Statute	Identifier	Facility Name	Facility Address	Facility County
FRS		110007803939	BRISAS DE LOIZA STP	PR-874 KM 7.1, CANOVANAS, PR 00729	Canóvanas Municipio
RCRAInfo	RCRA	PRD000689331	BRISAS DE LOIZA STP	STATE RD 874 KM 7.1, CANOVANAS, PR 00629	Canóvanas Municipio

Facility SIC (Standard Industrial

Facility NAICS (North American Industry

Classification) Codes

System	Identifier	SIC Code	SIC Description
No data records returned			

Classification System) Codes

System	Identifier	NAICS Code	NAICS Description
RCRAInfo	PRD000689331	22132	Sewage Treatment Facilities

Facility Tribe Information

Reservation Name	Tribe Name	EPA Tribal ID	Distance to Tribe (miles)
No data records returned			

Enforcement and Compliance

Compliance Monitoring History Last 5 Years

Statute	Source ID	System	Activity Type	Compliance Monitoring Type	Lead Agency	Date	Finding (if applicable)
No data records returned							

Entries in italics are not included in ECHO's Compliance Monitoring Activity counts because they are not compliance monitoring strategy <<https://www.epa.gov/compliance/compliance-monitoring-programs>> activities or because they are not counted as inspections within EPA's Annual Results <<https://www.epa.gov/enforcement/enforcement-data-and-results>>.

Compliance Summary Data

Statute	Source ID	Current SNC (Significant Noncompliance)/HPV (High Priority Violation)	Current As Of	Qtrs with NC (Noncompliance) (of 12)	Data Last Refreshed
RCRA	PRD000689331	No	10/19/2024	0	10/18/2024

Three-Year Compliance History by Quarter

Statute	Program/Pollutant/Violation Type	QTR 1	QTR 2	QTR 3	QTR 4	QTR 5	QTR 6	QTR 7	QTR 8	QTR 9	QTR 10	QTR 11	QTR 12+
RCRA (Source ID: PRD000689331)		10/01-12/31/21	01/01-03/31/22	04/01-06/30/22	07/01-09/30/22	10/01-12/31/22	01/01-03/31/23	04/01-06/30/23	07/01-09/30/23	10/01-12/31/23	01/01-03/31/24	04/01-06/30/24	07/01-09/30/24
	Facility-Level Status	No Violation Identified	No Violation Identified	No Violation Identified	No Violation Identified	No Violation Identified	No Violation Identified	No Violation Identified	No Violation Identified	No Violation Identified	No Violation Identified	No Violation Identified	No Violation Identified
	Violation												
	Agency												

Informal Enforcement Actions Last 5 Years

Statute	System	Source ID	Type of Action	Lead Agency	Date
No data records returned					

Entries in italics are not counted as "informal enforcement actions" in EPA policies pertaining to enforcement response tools.

Formal Enforcement Actions Last 5 Years

Statute	System	Law/Section	Source ID	Type of Action	Case No.	Lead Agency	Case Name	Issued/ Filed Date	Settlements/ Actions	Settlement/ Action Date	Federal Penalty Assessed	State/ Local Penalty Assessed	Penalty Amount Collected	SEP Value	Comp Action Cost
No data records returned															

Environmental Conditions

Watersheds

12-Digit WBD (Watershed Boundary Dataset) HUC (Reach Address Database)	WBD (Watershed Boundary Dataset) Subwatershed Name (RAD (Reach Address Database))	State Water Body Name (ICIS (Integrated Compliance Information System))	Beach Closures Within Last Year	Beach Closures Within Last Two Years	Pollutants Potentially Related to Impairment	Watershed with ESA (Endangered Species Act)-listed Aquatic Species?
No data records returned						

Assessed Waters From Latest State Submission (ATTAINS)

State	Report Cycle	Assessment Unit ID	Assessment Unit Name	Water Condition	Cause Groups Impaired	Drinking Water Use	Ecological Use	Fish Consumption Use	Recreation Use	Other Use
No data records returned										

Air Quality Nonattainment Areas

Pollutant	Within Nonattainment Status Area?	Nonattainment Status Applicable Standard(s)	Within Maintenance Status Area?	Maintenance Status Applicable Standard(s)
No data records returned				

Pollutants

Toxics Release Inventory History of Reported Chemicals Released or Transferred in Pounds per Year at Site

TRI Facility ID	Year	Air Emissions	Surface Water Discharges	Off-Site Transfers to POTWs (Publicly Owned Treatment Works)	Underground Injections	Disposal to Land	Total On-Site Releases	Total Off-Site Transfers
-----------------	------	---------------	--------------------------	--	------------------------	------------------	------------------------	--------------------------

No data records returned

Toxics Release Inventory Total Releases and Transfers in Pounds by Chemical and Year ⓘ

Chemical Name

No data records returned

Community

Environmental Justice

This section shows indexes from EJScreen, EPA's screening tool for environmental justice (EJ) concerns. EPA uses these indexes to identify geographic areas that may warrant further consideration or analysis for potential EJ concerns. Use of these indexes does not designate an area as an "EJ community" or "EJ facility." EJScreen provides screening level indicators, not a determination of the existence or absence of EJ concerns. For more information, see the EJScreen home page.



Potential Environmental Justice Concerns

US Territory

Supplemental/EJ index percentiles >= 90 (1-mile average)

EJScreen Indexes Shown

Index Type

Related Reports

EJScreen Community Report

[Download Data](#)

Census Block Group ID: 720291005041	US (Percentile)			State (Percentile)		
	Supplemental Indexes	Facility Census Block Group	1-mile Avg	1-mile Max	Facility Census Block Group	1-mile Avg
Count of Indexes At or Above 90th Percentile	0	3	7	0	0	4
Particulate Matter 2.5	--	N/A	--	--	N/A	--
Ozone	--	N/A	--	--	N/A	--
Diesel Particulate Matter	0	4	9	10	28	56
Air Toxics Cancer Risk	47	33	57	21	0	96
Air Toxics Respiratory Hazard Index	29	31	43	23	30	96
Toxic Releases to Air	89	97	99	42	66	99
Traffic Proximity	81	94	99	32	55	96
Lead Paint	43	50	99	20	22	94
Risk Management Plan (RMP) Facility Proximity	49	59	86	12	15	38
Hazardous Waste Proximity	71	86	99	24	45	92
Superfund Proximity	84	89	99	28	30	44
Underground Storage Tanks (UST)	76	73	99	62	61	94
Wastewater Discharge	89	92	99	36	37	75

Map Display Based on: US State

Display Map Layer

Facility 1-mile Radius Facility Census Block Group



Demographic Profile of Surrounding Area (1-Mile Radius)

This section provides demographic information regarding the community surrounding the facility. ECHO compliance data alone are not sufficient to determine whether violations at a particular facility had negative impacts on public health or the environment. Statistics are based upon the 2021 American Community Survey (ACS) 5-year Summary and are accurate to the extent that the facility latitude and longitude listed below are correct. Census boundaries and demographic data for U.S. Territories are based on the "2020 Island Areas Demographic Profiles" from the U.S. Census Bureau. EPA's spatial processing methodology considers the overlap between the selected radii and ACS census block groups in determining the demographics surrounding the facility. For more detail about this methodology, see the DFR Data Dictionary <<https://epa.gov/help/reports/dfr-data-dictionary#demographic>>.

General Statistics (ACS (American Community Survey))	
Total Persons	10,566
Population Density	3,430/sq.mi.
Housing Units in Area	4,017
Percent People of Color	100%
Households in Area	3,471
Households on Public Assistance	121
Persons With Low Income	5,923
Percent With Low Income	56%

Geography	
Radius of Selected Area	1 mi.
Center Latitude	18.373688
Center Longitude	-65.901655
Land Area	99%
Water Area	1%

Income Breakdown (ACS (American Community Survey)) - Households (%)	
Less than \$15,000	631 (18.16%)
\$15,000 - \$25,000	549 (15.8%)
\$25,000 - \$50,000	1,024 (29.48%)
\$50,000 - \$75,000	536 (15.43%)
Greater than \$75,000	734 (21.13%)

Age Breakdown (ACS (American Community Survey)) - Persons (%)	
Children 5 years and younger	403 (4%)
Minors 17 years and younger	2,019 (19%)
Adults 18 years and older	8,548 (81%)
Seniors 65 years and older	1,707 (16%)

Race Breakdown (ACS (American Community Survey)) - Persons (%)	
White	4,008 (38%)
African-American	0 (0%)
Hispanic-Origin	10,538 (100%)
Asian	14 (0%)
Hawaiian/Pacific Islander	0 (0%)
American Indian	10 (0%)
Other/Multiracial	3,257 (31%)

Education Level (Persons 25 & older) (ACS (American Community Survey)) - Persons (%)	
Less than 9th Grade	468 (6.25%)
9th through 12th Grade	350 (4.68%)
High School Diploma	1,748 (23.35%)
Some College/2-year	1,010 (13.49%)
B.S./B.A. (Bachelor of Science/Bachelor of Arts) or More	2,747 (36.7%)



Detailed Facility Report

Facility Summary

ALUMINUM EXTRUSSION CORP
PR-185 KM 0.65, CANOVANAS, PR 00729
FRS (Facility Registry Service) ID: 110007805688
EPA Region: 02
Latitude: 18.373702
Longitude: -65.899955
Locational Data Source: TRIS
Industries: Fabricated Metal Product Manufacturing
Indian Country: N

Enforcement and Compliance Summary

Statute	RCRA
Compliance Monitoring Activities (5 years)	--
Date of Last Compliance Monitoring Activity	01/21/2004
Compliance Status	No Violation Identified
Qtrs in Noncompliance (of 12)	0
Qtrs with Significant Violation	0
Informal Enforcement Actions (5 years)	--
Formal Enforcement Actions (5 years)	--
Penalties from Formal Enforcement Actions (5 years)	--
EPA Cases (5 years)	--
Penalties from EPA Cases (5 years)	--

Regulatory Information

Clean Air Act (CAA): No Information
Clean Water Act (CWA): No Information
Resource Conservation and Recovery Act (RCRA): Inactive Other, (PRN008011124), Inactive Other, (PRD090000068)
Safe Drinking Water Act (SDWA): No Information

Other Regulatory Reports

Air Emissions Inventory (EIS): No Information
Greenhouse Gas Emissions (eGGRT): No Information
Toxic Releases (TRI): 00629LMNMP185RO
Compliance and Emissions Data Reporting Interface (CEDRI): No Information

Go To Enforcement/Compliance Details
 Known Data Problems <<https://epa.gov/resources/echo-data/known-data-problems>>

Facility/System Characteristics

Facility/System Characteristics

System	Statute	Identifier	Universe	Status	Areas	Permit Expiration Date	Indian Country	Latitude	Longitude
FRS		110007805688					N	18.373702	-65.899955
TRI	EP313	00629LMNMP185RO	Toxics Release Inventory	Last Reported for 1992			N	18.373702	-65.899955
RCRAInfo	RCRA	PRN008011124	Other	Inactive ()			N	18.373702	-65.899955
RCRAInfo	RCRA	PRD090000068	Other	Inactive ()			N	18.373702	-65.899955

Facility Address

System	Statute	Identifier	Facility Name	Facility Address	Facility County
FRS		110007805688	ALUMINUM EXTRUSSION CORP	PR-185 KM 0.65, CANOVANAS, PR 00729	Canóvanas Municipio
TRI	EP313	00629LMNMP185RO	ALUMINUM PROCESSING CORP	185 STATE RD KM 065, CANOVANAS, PR 00729	Canóvanas Municipio

System	Statute	Identifier	Facility Name	Facility Address	Facility County
RCRAInfo	RCRA	PRN008011124	PERFILES DE ALUMINIO	STATE RD 185 KM 0.65, CANOVANAS, PR 00729-1622	Canóvanas Municipio
RCRAInfo	RCRA	PRD090000068	ALUMINUM EXTRUSSION CORP	RD 185 KM 0.65, CANOVANAS, PR 00629	Canóvanas Municipio

Facility SIC (Standard Industrial Classification) Codes

System	Identifier	SIC Code	SIC Description
TRI	00629LMNMP185RO	3354	Aluminum Extruded Products
TRI	00629LMNMP185RO	3471	Plating And Polishing

Facility NAICS (North American Industry Classification System) Codes

System	Identifier	NAICS Code	NAICS Description
TRI	00629LMNMP185RO	332813	Electroplating, Plating, Polishing, Anodizing, and Coloring
RCRAInfo	PRD090000068	331316	Aluminum Extruded Product Manufacturing

Facility Tribe Information

Reservation Name	Tribe Name	EPA Tribal ID	Distance to Tribe (miles)
No data records returned			

Enforcement and Compliance

Compliance Monitoring History Last 5 Years

Statute	Source ID	System	Activity Type	Compliance Monitoring Type	Lead Agency	Date	Finding (if applicable)
No data records returned							

No data records returned

Entries in italics are not included in ECHO's Compliance Monitoring Activity counts because they are not compliance monitoring strategy <https://www.epa.gov/compliance/compliance-monitoring-programs> activities or because they are not counted as inspections within EPA's Annual Results <https://www.epa.gov/enforcement/enforcement-data-and-results>.

Compliance Summary Data

Statute	Source ID	Current SNC (Significant Noncompliance)/HPV (High Priority Violation)	Current As Of	Qtrs with NC (Noncompliance) (of 12)	Data Last Refreshed
RCRA	PRN008011124	No	10/19/2024	0	10/18/2024
RCRA	PRD090000068	No	10/19/2024	0	10/18/2024

Three-Year Compliance History by Quarter

Statute	Program/Pollutant/Violation Type	QTR 1	QTR 2	QTR 3	QTR 4	QTR 5	QTR 6	QTR 7	QTR 8	QTR 9	QTR 10	QTR 11	QTR 12+
RCRA (Source ID: PRD090000068)	Facility-Level Status	No Violation Identified	No Violation Identified	No Violation Identified	No Violation Identified	No Violation Identified	No Violation Identified	No Violation Identified	No Violation Identified	No Violation Identified	No Violation Identified	No Violation Identified	No Violation Identified
	Violation												
	Agency												
RCRA (Source ID: PRN008011124)	Facility-Level Status	No Violation Identified	No Violation Identified	No Violation Identified	No Violation Identified	No Violation Identified	No Violation Identified	No Violation Identified	No Violation Identified	No Violation Identified	No Violation Identified	No Violation Identified	No Violation Identified
	Violation												
	Agency												

Informal Enforcement Actions Last 5 Years

Statute	System	Source ID	Type of Action	Lead Agency	Date
No data records returned					

No data records returned

Entries in italics are not counted as "informal enforcement actions" in EPA policies pertaining to enforcement response tools.

Formal Enforcement Actions Last 5 Years

Statute	System	Law/Section	Source ID	Type of Action	Case No.	Lead Agency	Case Name	Issued/ Filed Date	Settlements/ Actions	Settlement/ Action Date	Federal Penalty Assessed	State/ Local Penalty Assessed	Penalty Amount Collected	SEP Value	Comp Action Cost
No data records returned															

No data records returned

Environmental Conditions

Watersheds

12-Digit WBD (Watershed Boundary Dataset) HUC (RAD (Reach Address Database))	WBD (Watershed Boundary Dataset) Subwatershed Name (RAD (Reach Address Database))	State Water Body Name (ICIS (Integrated Compliance Information System))	Beach Closures Within Last Year	Beach Closures Within Last Two Years	Pollutants Potentially Related to Impairment	Watershed with ESA (Endangered Species Act)-listed Aquatic Species?
No data records returned						

No data records returned

Assessed Waters From Latest State Submission (ATTAINS)

State	Report Cycle	Assessment Unit ID	Assessment Unit Name	Water Condition	Cause Groups Impaired	Drinking Water Use	Ecological Use	Fish Consumption Use	Recreation Use	Other Use
No data records returned										

No data records returned

Air Quality Nonattainment Areas

Pollutant	Within Nonattainment Status Area?	Nonattainment Status Applicable Standard(s)	Within Maintenance Status Area?	Maintenance Status Applicable Standard(s)
No data records returned				

Pollutants

Toxics Release Inventory History of Reported Chemicals Released or Transferred in Pounds per Year at Site ?

TRI Facility ID	Year	Air Emissions	Surface Water Discharges	Off-Site Transfers to POTWs (Publicly Owned Treatment Works)	Underground Injections	Disposal to Land	Total On-Site Releases	Total Off-Site Transfers
No data records returned								

Toxics Release Inventory Total Releases and Transfers in Pounds by Chemical and Year ?

Chemical Name
No data records returned

Community

Environmental Justice

This section shows indexes from EJScreen, EPA's screening tool for environmental justice (EJ) concerns. EPA uses these indexes to identify geographic areas that may warrant further consideration or analysis for potential EJ concerns. Use of these indexes does not designate an area as an "EJ community" or "EJ facility." EJScreen provides screening level indicators, not a determination of the existence or absence of EJ concerns. For more information, see the EJScreen home page.



Potential Environmental Justice Concerns

US Territory

Supplemental/EJ index percentiles >= 90 (1-mile average)

EJScreen Indexes Shown

Index Type ⌵

Related Reports

EJScreen Community Report

[Download Data](#)

Supplemental Indexes	US (Percentile)			State (Percentile)		
	Facility Census Block Group	1-mile Avg	1-mile Max	Facility Census Block Group	1-mile Avg	1-mile Max
Count of Indexes At or Above 90th Percentile	0	3	7	0	0	4
Particulate Matter 2.5	--	N/A	--	--	N/A	--
Ozone	--	N/A	--	--	N/A	--
Diesel Particulate Matter	0	4	9	10	26	56
Air Toxics Cancer Risk	47	33	57	21	0	! 96
Air Toxics Respiratory Hazard Index	29	31	43	23	29	! 96
Toxic Releases to Air	89	! 97	! 99	42	65	! 99
Traffic Proximity	81	! 94	! 99	32	54	! 96
Lead Paint	43	53	! 99	20	22	! 94
Risk Management Plan (RMP) Facility Proximity	49	57	86	12	15	38
Hazardous Waste Proximity	71	85	! 99	24	42	! 92
Superfund Proximity	84	88	! 99	28	29	44
Underground Storage Tanks (UST)	76	76	! 99	62	61	! 94
Wastewater Discharge	89	! 92	! 99	36	38	75

Map Display Based on: US State

Display Map Layer ⌵

Facility 1-mile Radius Facility Census Block Group

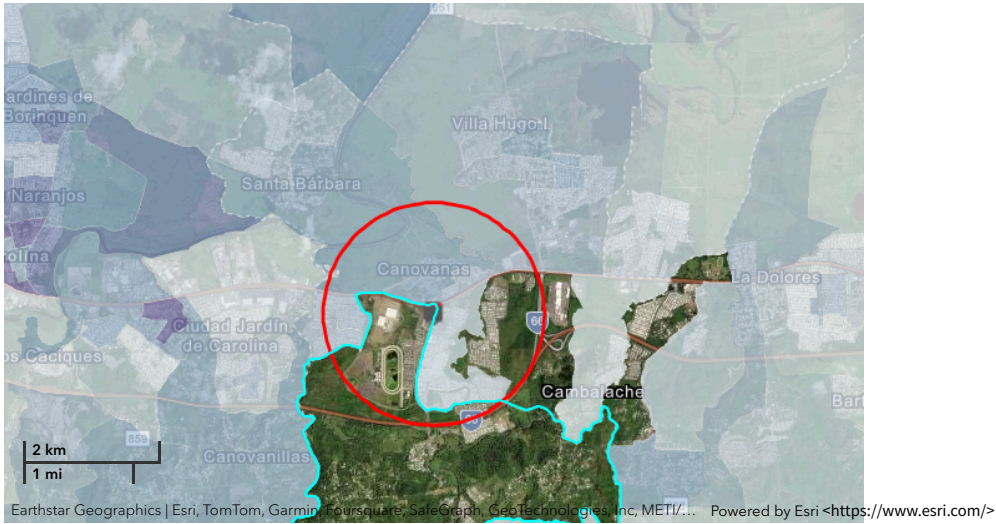

Demographic Profile of Surrounding Area (1-Mile Radius)

This section provides demographic information regarding the community surrounding the facility. ECHO compliance data alone are not sufficient to determine whether violations at a particular facility had negative impacts on public health or the environment. Statistics are based upon the 2021 American Community Survey (ACS) 5-year Summary and are accurate to the extent that the facility latitude and longitude listed below are correct. Census boundaries and demographic data for U.S. Territories are based on the "2020 Island Areas Demographic Profiles" from the U.S. Census Bureau. EPA's spatial processing methodology considers the overlap between the selected radii and ACS census block groups in determining the demographics surrounding the facility. For more detail about this methodology, see the DFR Data Dictionary <<https://epa.gov/help/reports/dfr-data-dictionary#demographic>>.

General Statistics (ACS (American Community Survey))	
Total Persons	10,085
Population Density	3,271/sq.mi.
Housing Units in Area	3,804
Percent People of Color	100%
Households in Area	3,311
Households on Public Assistance	118
Persons With Low Income	5,450
Percent With Low Income	54%

Geography	
Radius of Selected Area	1 mi.
Center Latitude	18.373702
Center Longitude	-65.899955
Land Area	99%
Water Area	1%

Income Breakdown (ACS (American Community Survey)) - Households (%)	
Less than \$15,000	589 (17.79%)
\$15,000 - \$25,000	501 (15.14%)
\$25,000 - \$50,000	947 (28.61%)
\$50,000 - \$75,000	516 (15.59%)
Greater than \$75,000	757 (22.87%)

Age Breakdown (ACS (American Community Survey)) - Persons (%)	
Children 5 years and younger	395 (4%)
Minors 17 years and younger	1,976 (20%)
Adults 18 years and older	8,107 (80%)
Seniors 65 years and older	1,568 (16%)

Race Breakdown (ACS (American Community Survey)) - Persons (%)	
White	3,890 (39%)
African-American	0 (0%)
Hispanic-Origin	10,057 (100%)
Asian	18 (0%)
Hawaiian/Pacific Islander	0 (0%)
American Indian	13 (0%)
Other/Multiracial	3,061 (30%)

Education Level (Persons 25 & older) (ACS (American Community Survey)) - Persons (%)	
Less than 9th Grade	444 (6.27%)
9th through 12th Grade	314 (4.44%)
High School Diploma	1,571 (22.2%)
Some College/2-year	954 (13.48%)
B.S./B.A. (Bachelor of Science/Bachelor of Arts) or More	2,675 (37.8%)



Detailed Facility Report

Facility Summary

EXTENSION CANOVANAS PLAZA RIAL II

CARR. PR-185 KM 0.07, CANOVANAS, PR 00729

FRS (Facility Registry Service) ID: 110070568020

EPA Region: 02

Latitude: 18.3731

Longitude: -65.9014

Locational Data Source: NPDES

Industries: --

Indian Country: N

Enforcement and Compliance Summary

Statute	CWA
Compliance Monitoring Activities (5 years)	--
Date of Last Compliance Monitoring Activity	--
Compliance Status	Terminated Permit
Qtrs in Noncompliance (of 12)	0
Qtrs with Significant Violation	0
Informal Enforcement Actions (5 years)	--
Formal Enforcement Actions (5 years)	--
Penalties from Formal Enforcement Actions (5 years)	--
EPA Cases (5 years)	--
Penalties from EPA Cases (5 years)	--

Regulatory Information

Clean Air Act (CAA): No Information

Clean Water Act (CWA): Non-Major, Permit Terminated; Compliance Tracking Off (PRR10008F), Non-Major, Permit Terminated; Compliance Tracking Off (PRR10008A)

Resource Conservation and Recovery Act (RCRA): No Information

Safe Drinking Water Act (SDWA): No Information

Other Regulatory Reports

Air Emissions Inventory (EIS): No Information

Greenhouse Gas Emissions (eGGRT): No Information

Toxic Releases (TRI): No Information

Compliance and Emissions Data Reporting Interface (CEDRI): No Information

Go To Enforcement/Compliance Details

Known Data Problems <<https://epa.gov/resources/echo-data/known-data-problems>>

Facility/System Characteristics

Facility/System Characteristics

System	Statute	Identifier	Universe	Status	Areas	Permit Expiration Date	Indian Country	Latitude	Longitude
FRS		110070568020					N	18.3731	-65.9014
ICIS-NPDES	CWA	PRR10008F	Non-Major: General Permit Covered Facility	Terminated; Compliance Tracking Off	Construction Stormwater	02/15/2022	N	18.3731	-65.9014
ICIS-NPDES	CWA	PRR10008A	Non-Major: General Permit Covered Facility	Terminated; Compliance Tracking Off	Construction Stormwater	02/15/2022	N	18.3731	-65.9014

Facility Address

System	Statute	Identifier	Facility Name	Facility Address	Facility County
FRS		110070568020	EXTENSION CANOVANAS PLAZA RIAL II	CARR. PR-185 KM 0.07, CANOVANAS, PR 00729	Canóvanas Municipio
ICIS-NPDES	CWA	PRR10008F	EXTENSION CANOVANAS PLAZA RIAL II	CARR. PR-185 KM 0.07, CANOVANAS, PR 00729	
ICIS-NPDES	CWA	PRR10008A	EXTENSION CANOVANAS PLAZA RIAL II	CARR. PR-185 KM 0.07, CANOVANAS, PR 00729	

Facility SIC (Standard Industrial Classification) Facility NAICS (North American Industry

Codes

Classification System) Codes

System	Identifier	SIC Code	SIC Description	System	Identifier	NAICS Code	NAICS Description
No data records returned				No data records returned			

Facility Industrial Effluent Guidelines

Facility Tribe Information

Identifier	Effluent Guideline (40 CFR Part)	Effluent Guideline Description	Reservation Name	Tribe Name	EPA Tribal ID	Distance to Tribe (miles)
No data records returned			No data records returned			

Enforcement and Compliance

Compliance Monitoring History Last 5 Years

Statute	Source ID	System	Activity Type	Compliance Monitoring Type	Lead Agency	Date	Finding (if applicable)
No data records returned							

Entries in italics are not included in ECHO's Compliance Monitoring Activity counts because they are not compliance monitoring strategy <<https://www.epa.gov/compliance/compliance-monitoring-programs>> activities or because they are not counted as inspections within EPA's Annual Results <<https://www.epa.gov/enforcement/enforcement-data-and-results>>.

Compliance Summary Data

Statute	Source ID	Current SNC (Significant Noncompliance)/HPV (High Priority Violation)	Current As Of	Qtrs with NC (Noncompliance) (of 12)	Data Last Refreshed
CWA	PRR10008F	No	06/30/2024	0	10/18/2024
CWA	PRR10008A	No	06/30/2024	0	10/18/2024

Three-Year Compliance History by Quarter

Statute	Program/Pollutant/Violation Type	QTR 1	QTR 2	QTR 3	QTR 4	QTR 5	QTR 6	QTR 7	QTR 8	QTR 9	QTR 10	QTR 11	QTR 12	QTR 1
CWA (Source ID: PRR10008F)		07/01-09/30/21	10/01-12/31/21	01/01-03/31/22	04/01-06/30/22	07/01-09/30/22	10/01-12/31/22	01/01-03/31/23	04/01-06/30/23	07/01-09/30/23	10/01-12/31/23	01/01-03/31/24	04/01-06/30/24	07/01-10/31/24
	Facility-Level Status	Terminated Permit	Terminated Permit	Terminated Permit	Terminated Permit	Terminated Permit	Terminated Permit	Terminated Permit	Terminated Permit	Terminated Permit	Terminated Permit	Terminated Permit	Terminated Permit	Terminated Permit
	Quarterly Noncompliance Report History													
CWA (Source ID: PRR10008A)		07/01-09/30/21	10/01-12/31/21	01/01-03/31/22	04/01-06/30/22	07/01-09/30/22	10/01-12/31/22	01/01-03/31/23	04/01-06/30/23	07/01-09/30/23	10/01-12/31/23	01/01-03/31/24	04/01-06/30/24	07/01-10/31/24
	Facility-Level Status	Terminated Permit	Terminated Permit	Terminated Permit	Terminated Permit	Terminated Permit	Terminated Permit	Terminated Permit	Terminated Permit	Terminated Permit	Terminated Permit	Terminated Permit	Terminated Permit	Terminated Permit
	Quarterly Noncompliance Report History													

Informal Enforcement Actions Last 5 Years

Statute	System	Source ID	Type of Action	Lead Agency	Date
No data records returned					

Entries in italics are not counted as "informal enforcement actions" in EPA policies pertaining to enforcement response tools.

Formal Enforcement Actions Last 5 Years

Statute	System	Law/Section	Source ID	Type of Action	Case No.	Lead Agency	Case Name	Issued/ Filed Date	Settlements/ Actions	Settlement/ Action Date	Federal Penalty Assessed	State/ Local Penalty Assessed	Penalty Amount Collected	SEP Value	Comp Action Cost
No data records returned															

Environmental Conditions

Watersheds

12-Digit WBD (Watershed Boundary Dataset) HUC (RAD (Reach Address Database))	WBD (Watershed Boundary Dataset) Subwatershed Name (RAD (Reach Address Database))	State Water Body Name (ICIS (Integrated Compliance Information System))	Beach Closures Within Last Year	Beach Closures Within Last Two Years	Pollutants Potentially Related to Impairment	Watershed with ESA (Endangered Species Act)-listed Aquatic Species?
210100050414	Rio Grande de Loiza at mouth	BOCAFORMA CREEK	No	No	--	Yes

Assessed Waters From Latest State Submission (ATTAINS)

State	Report Cycle	Assessment Unit ID	Assessment Unit Name	Water Condition	Cause Groups Impaired	Drinking Water Use	Ecological Use	Fish Consumption Use	Recreation Use	Other Use
PR	2022	PREE14A	RIO GRANDE DE LOIZA ESTUARY	Impaired - With Restoration Plan	PATHOGENS	--	Insufficient Information	--	Not Supporting	--

Air Quality Nonattainment Areas

Pollutant	Within Nonattainment Status Area?	Nonattainment Status Applicable Standard(s)	Within Maintenance Status Area?	Maintenance Status Applicable Standard(s)
No data records returned				

Pollutants

Toxics Release Inventory History of Reported Chemicals Released or Transferred in Pounds per Year at Site ⓘ

TRI Facility ID Year Air Emissions Surface Water Discharges Off-Site Transfers to POTWs (Publicly Owned Treatment Works) Underground Injections Disposal to Land Total On-Site Releases Total Off-Site Transfers

No data records returned

Toxics Release Inventory Total Releases and Transfers in Pounds by Chemical and Year ⓘ

Chemical Name

No data records returned

CWA (Clean Water Act) Discharge Monitoring Report (DMR) Pollutant Loadings ⓘ

DMR and TRI Multi-Year Loading Report

NPDES ID

Description

No data records returned

Community

Environmental Justice

This section shows indexes from EJScreen, EPA's screening tool for environmental justice (EJ) concerns. EPA uses these indexes to identify geographic areas that may warrant further consideration or analysis for potential EJ concerns. Use of these indexes does not designate an area as an "EJ community" or "EJ facility." EJScreen provides screening level indicators, not a determination of the existence or absence of EJ concerns. For more information, see the EJScreen home page.



Potential Environmental Justice Concerns

US Territory

Supplemental/EJ index percentiles >= 90 (1-mile average)

EJScreen Indexes Shown

Index Type

Supplemental (default) ⌵

Related Reports

EJScreen Community Report

Download Data

Supplemental Indexes	US (Percentile)			State (Percentile)		
	Facility Census Block Group	1-mile Avg	1-mile Max	Facility Census Block Group	1-mile Avg	1-mile Max
Count of Indexes At or Above 90th Percentile	0	3	7	0	0	4
Particulate Matter 2.5	--	N/A	--	--	N/A	--
Ozone	--	N/A	--	--	N/A	--
Diesel Particulate Matter	0	4	9	10	27	56
Air Toxics Cancer Risk	47	33	57	21	0	96
Air Toxics Respiratory Hazard Index	29	31	43	23	29	96
Toxic Releases to Air	89	97	99	42	65	99
Traffic Proximity	81	94	99	32	54	96
Lead Paint	43	52	99	20	22	94
Risk Management Plan (RMP) Facility Proximity	49	58	86	12	15	38
Hazardous Waste Proximity	71	85	99	24	43	92
Superfund Proximity	84	88	99	28	30	44
Underground Storage Tanks (UST)	76	74	99	62	61	94
Wastewater Discharge	89	92	99	36	37	75

Map Display Based on: US State

Display Map Layer Summary - Number of Indexes ⌵

Facility 1-mile Radius Facility Census Block Group

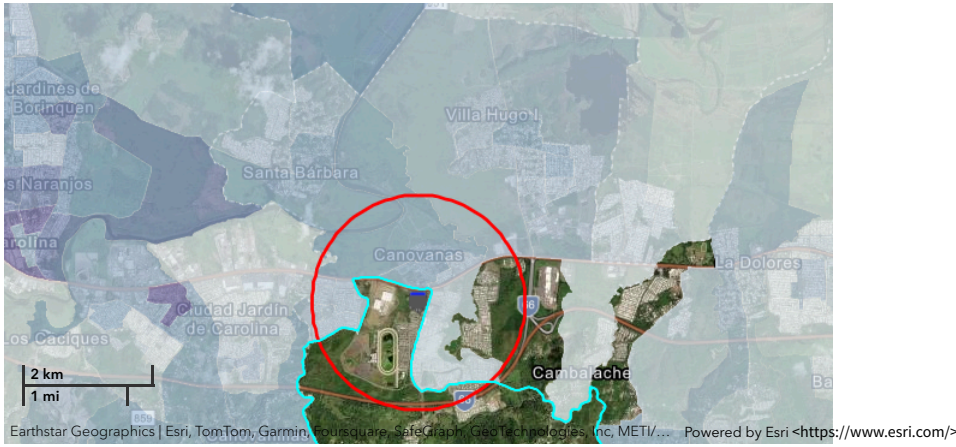

Demographic Profile of Surrounding Area (1-Mile Radius)

This section provides demographic information regarding the community surrounding the facility. ECHO compliance data alone are not sufficient to determine whether violations at a particular facility had negative impacts on public health or the environment. Statistics are based upon the 2021 American Community Survey (ACS) 5-year Summary and are accurate to the extent that the facility latitude and longitude listed below are correct. Census boundaries and demographic data for U.S. Territories are based on the "2020 Island Areas Demographic Profiles" from the U.S. Census Bureau. EPA's spatial processing methodology considers the overlap between the selected radii and ACS census block groups in determining the demographics surrounding the facility. For more detail about this methodology, see the DFR Data Dictionary <<https://epa.gov/help/reports/dfp-data-dictionary#demographic>>.

General Statistics (ACS (American Community Survey))	
Total Persons	10,570
Population Density	3,429/sq.mi.
Housing Units in Area	4,003
Percent People of Color	100%
Households in Area	3,464
Households on Public Assistance	122
Persons With Low Income	5,873
Percent With Low Income	56%

Geography	
Radius of Selected Area	1 mi.
Center Latitude	18.3731
Center Longitude	-65.9014
Land Area	99%
Water Area	1%

Income Breakdown (ACS (American Community Survey)) - Households (%)	
Less than \$15,000	617 (17.82%)
\$15,000 - \$25,000	543 (15.68%)
\$25,000 - \$50,000	1,018 (29.4%)
\$50,000 - \$75,000	538 (15.54%)
Greater than \$75,000	747 (21.57%)

Age Breakdown (ACS (American Community Survey)) - Persons (%)	
Children 5 years and younger	405 (4%)
Minors 17 years and younger	2,025 (19%)
Adults 18 years and older	8,545 (81%)
Seniors 65 years and older	1,697 (16%)

Race Breakdown (ACS (American Community Survey)) - Persons (%)	
White	4,019 (38%)
African-American	0 (0%)
Hispanic-Origin	10,542 (100%)
Asian	15 (0%)
Hawaiian/Pacific Islander	0 (0%)
American Indian	11 (0%)
Other/Multiracial	3,245 (31%)

Education Level (Persons 25 & older) (ACS (American Community Survey)) - Persons (%)	
Less than 9th Grade	463 (6.19%)
9th through 12th Grade	342 (4.57%)
High School Diploma	1,729 (23.11%)
Some College/2-year	1,010 (13.5%)
B.S./B.A. (Bachelor of Science/Bachelor of Arts) or More	2,768 (36.99%)



Detailed Facility Report

Facility Summary

PHOTORECEPTOR SYSTEMS, INC.

CALLE 2, ESQ 3 CANOVANAS IND., CANOVANAS, PR 00729

FRS (Facility Registry Service) ID: 110006433564

EPA Region: 02

Latitude: 18.36843

Longitude: -65.90082

Locational Data Source: FRS

Industries: --

Indian Country: N

Enforcement and Compliance Summary

Statute	RCRA
Compliance Monitoring Activities (5 years)	--
Date of Last Compliance Monitoring Activity	12/01/1989
Compliance Status	No Violation Identified
Qtrs in Noncompliance (of 12)	0
Qtrs with Significant Violation	0
Informal Enforcement Actions (5 years)	--
Formal Enforcement Actions (5 years)	--
Penalties from Formal Enforcement Actions (5 years)	--
EPA Cases (5 years)	--
Penalties from EPA Cases (5 years)	--

Regulatory Information

Clean Air Act (CAA): No Information

Clean Water Act (CWA): No Information

Resource Conservation and Recovery Act (RCRA): Inactive Other, (PRD980526545)

Safe Drinking Water Act (SDWA): No Information

Other Regulatory Reports

Air Emissions Inventory (EIS): No Information

Greenhouse Gas Emissions (eGGR): No Information

Toxic Releases (TRI): No Information

Compliance and Emissions Data Reporting Interface (CEDRI): No Information

Go To Enforcement/Compliance Details

Known Data Problems <<https://epa.gov/resources/echo-data/known-data-problems>>

Facility/System Characteristics

Facility/System Characteristics

System	Statute	Identifier	Universe	Status	Areas	Permit Expiration Date	Indian Country	Latitude	Longitude
FRS		110006433564					N	18.36843	-65.90082
ICIS		31952					N	18.376528	-65.899722
RCRAInfo	RCRA	PRD980526545	Other	Inactive ()			N		

Facility Address

System	Statute	Identifier	Facility Name	Facility Address	Facility County
FRS		110006433564	PHOTORECEPTOR SYSTEMS, INC.	CALLE 2, ESQ 3 CANOVANAS IND., CANOVANAS, PR 00729	Canóvanas Municipio
ICIS		31952	PHOTORECEPTOR SYSTEMS, INC.	CALLE 2, ESQ 3 CANOVANAS IND., CANOVANAS, PR 00729	Canóvanas Municipio
RCRAInfo	RCRA	PRD980526545	PHOTORECEPTOR SYSTEMS INC	CALLE 2 ESQ 3 CANOVANAS IND, CANOVANAS, PR 00629	Canóvanas Municipio

Facility SIC (Standard Industrial Classification) Codes

System	Identifier	SIC Code	SIC Description
--------	------------	----------	-----------------

No data records returned

Facility NAICS (North American Industry Classification System) Codes

System	Identifier	NAICS Code	NAICS Description
--------	------------	------------	-------------------

No data records returned

Facility Tribe Information

Reservation Name	Tribe Name	EPA Tribal ID	Distance to Tribe (miles)
------------------	------------	---------------	---------------------------

No data records returned

Enforcement and Compliance

Compliance Monitoring History Last 5 Years

Statute	Source ID	System	Activity Type	Compliance Monitoring Type	Lead Agency	Date	Finding (if applicable)
---------	-----------	--------	---------------	----------------------------	-------------	------	-------------------------

No data records returned

Entries in italics are not included in ECHO's Compliance Monitoring Activity counts because they are not compliance monitoring strategy <https://www.epa.gov/compliance/compliance-monitoring-programs> activities or because they are not counted as inspections within EPA's Annual Results <https://www.epa.gov/enforcement/enforcement-data-and-results>.

Compliance Summary Data

Statute	Source ID	Current SNC (Significant Noncompliance)/HPV (High Priority Violation)	Current As Of	Qtrs with NC (Noncompliance) (of 12)	Data Last Refreshed
RCRA	PRD980526545	No	10/19/2024	0	10/18/2024

Three-Year Compliance History by Quarter

Statute	Program/Pollutant/Violation Type	QTR 1	QTR 2	QTR 3	QTR 4	QTR 5	QTR 6	QTR 7	QTR 8	QTR 9	QTR 10	QTR 11	QTR 12+
RCRA (Source ID: PRD980526545)		10/01-12/31/21	01/01-03/31/22	04/01-06/30/22	07/01-09/30/22	10/01-12/31/22	01/01-03/31/23	04/01-06/30/23	07/01-09/30/23	10/01-12/31/23	01/01-03/31/24	04/01-06/30/24	07/01-09/30/24
	Facility-Level Status	No Violation Identified	No Violation Identified	No Violation Identified	No Violation Identified	No Violation Identified	No Violation Identified	No Violation Identified	No Violation Identified	No Violation Identified	No Violation Identified	No Violation Identified	No Violation Identified
	Violation												
	Agency												

Informal Enforcement Actions Last 5 Years

Statute	System	Source ID	Type of Action	Lead Agency	Date
---------	--------	-----------	----------------	-------------	------

No data records returned

Entries in italics are not counted as "informal enforcement actions" in EPA policies pertaining to enforcement response tools.

Formal Enforcement Actions Last 5 Years

Statute	System	Law/Section	Source ID	Type of Action	Case No.	Lead Agency	Case Name	Issued/ Filed Date	Settlements/ Actions	Settlement/ Action Date	Federal Penalty Assessed	State/ Local Penalty Assessed	Penalty Amount Collected	SEP Value	Comp Action Cost
---------	--------	-------------	-----------	----------------	----------	-------------	-----------	--------------------	----------------------	-------------------------	--------------------------	-------------------------------	--------------------------	-----------	------------------

No data records returned

Environmental Conditions

Watersheds

12-Digit WBD (Watershed Boundary Dataset) HUC (RAD (Reach Address Database))	WBD (Watershed Boundary Dataset) Subwatershed Name (RAD (Reach Address Database))	State Water Body Name (ICIS (Integrated Compliance Information System))	Beach Closures Within Last Year	Beach Closures Within Last Two Years	Pollutants Potentially Related to Impairment	Watershed with ESA (Endangered Species Act)-listed Aquatic Species?
--	---	---	---------------------------------	--------------------------------------	--	---

No data records returned

Assessed Waters From Latest State Submission (ATTAINS)

State	Report Cycle	Assessment Unit ID	Assessment Unit Name	Water Condition	Cause Groups Impaired	Drinking Water Use	Ecological Use	Fish Consumption Use	Recreation Use	Other Use
-------	--------------	--------------------	----------------------	-----------------	-----------------------	--------------------	----------------	----------------------	----------------	-----------

No data records returned

Air Quality Nonattainment Areas

Pollutant	Within Nonattainment Status Area?	Nonattainment Status Applicable Standard(s)	Within Maintenance Status Area?	Maintenance Status Applicable Standard(s)
-----------	-----------------------------------	---	---------------------------------	---

No data records returned

Pollutants

Toxics Release Inventory History of Reported Chemicals Released or Transferred in Pounds per Year at Site ⓘ

TRI Facility ID	Year	Air Emissions	Surface Water Discharges	Off-Site Transfers to POTWs (Publicly Owned Treatment Works)	Underground Injections	Disposal to Land	Total On-Site Releases	Total Off-Site Transfers
-----------------	------	---------------	--------------------------	--	------------------------	------------------	------------------------	--------------------------

No data records returned

Toxics Release Inventory Total Releases and Transfers in Pounds by Chemical and Year ⓘ

Chemical Name
No data records returned

Community

Environmental Justice

This section shows indexes from EJScreen, EPA's screening tool for environmental justice (EJ) concerns. EPA uses these indexes to identify geographic areas that may warrant further consideration or analysis for potential EJ concerns. Use of these indexes does not designate an area as an "EJ community" or "EJ facility." EJScreen provides screening level indicators, not a determination of the existence or absence of EJ concerns. For more information, see the EJScreen home page.



Potential Environmental Justice Concerns

- US Territory
- Supplemental/EJ index percentiles >= 90 (Census block group)
- Supplemental/EJ index percentiles >= 90 (1-mile average)

EJScreen Indexes Shown

Index Type ⬇ ⬆

Related Reports

EJScreen Community Report

[Download Data](#)

Supplemental Indexes	US (Percentile)			State (Percentile)		
	Facility Census Block Group	1-mile Avg	1-mile Max	Facility Census Block Group	1-mile Avg	1-mile Max
Count of Indexes At or Above 90th Percentile	3	3	7	0	0	4
Particulate Matter 2.5	--	N/A	--	--	N/A	--
Ozone	--	N/A	--	--	N/A	--
Diesel Particulate Matter	3	4	9	19	25	56
Air Toxics Cancer Risk	49	33	57	23	0	ⓘ 96
Air Toxics Respiratory Hazard Index	30	30	43	25	28	ⓘ 96
Toxic Releases to Air	ⓘ 95	ⓘ 96	ⓘ 99	61	63	ⓘ 99
Traffic Proximity	ⓘ 92	ⓘ 93	ⓘ 99	48	52	ⓘ 96
Lead Paint	0	53	ⓘ 99	0	22	ⓘ 94
Risk Management Plan (RMP) Facility Proximity	51	57	82	13	15	31
Hazardous Waste Proximity	82	84	ⓘ 97	37	41	82
Superfund Proximity	86	88	ⓘ 99	28	29	44
Underground Storage Tanks (UST)	87	75	ⓘ 99	63	61	ⓘ 94
Wastewater Discharge	ⓘ 93	ⓘ 92	ⓘ 99	41	37	70

Map Display Based on: US State

Display Map Layer ⬇ ⬆

Facility 1-mile Radius Facility Census Block Group

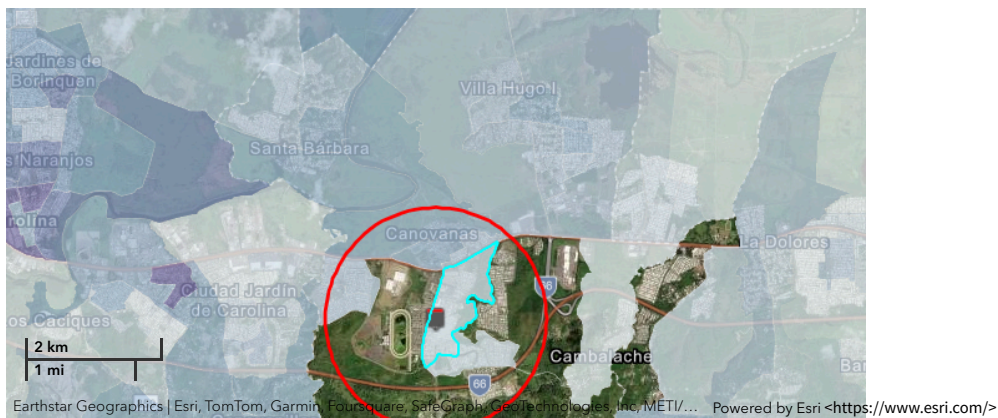

Demographic Profile of Surrounding Area (1-Mile Radius)

This section provides demographic information regarding the community surrounding the facility. ECHO compliance data alone are not sufficient to determine whether violations at a particular facility had negative impacts on public health or the environment. Statistics are based upon the 2021 American Community Survey (ACS) 5-year Summary and are accurate to the extent that the facility latitude and longitude listed below are correct. Census boundaries and demographic data for U.S. Territories are based on the "2020 Island Areas Demographic Profiles" from the U.S. Census Bureau. EPA's spatial processing methodology considers the overlap between the selected radii and ACS census block groups in determining the demographics surrounding the facility. For more detail about this methodology, see the DFR Data Dictionary <<https://epa.gov/help/reports/dfp-data-dictionary#demographic>>.

General Statistics (ACS (American Community Survey))

Total Persons	10,295
Population Density	3,321/sq. mi.
Housing Units in Area	3,807
Percent People of Color	100%
Households in Area	3,346
Households on Public Assistance	113
Persons With Low Income	5,417
Percent With Low Income	53%

Geography

Radius of Selected Area	1 mi.
Center Latitude	18.36843
Center Longitude	-65.90082
Land Area	99%
Water Area	1%

Income Breakdown (ACS (American Community Survey)) - Households (%)

Less than \$15,000	528 (15.78%)
\$15,000 - \$25,000	496 (14.82%)
\$25,000 - \$50,000	970 (28.98%)
\$50,000 - \$75,000	552 (16.49%)
Greater than \$75,000	801 (23.93%)

Age Breakdown (ACS (American Community Survey)) - Persons (%)

Children 5 years and younger	391 (4%)
Minors 17 years and younger	2,005 (19%)
Adults 18 years and older	8,289 (81%)
Seniors 65 years and older	1,600 (16%)

Race Breakdown (ACS (American Community Survey)) - Persons (%)

White	3,965 (39%)
African-American	0 (0%)
Hispanic-Origin	10,267 (100%)
Asian	14 (0%)
Hawaiian/Pacific Islander	0 (0%)
American Indian	12 (0%)
Other/Multiracial	3,134 (30%)

Education Level (Persons 25 & older) (ACS (American Community Survey)) - Persons (%)

Less than 9th Grade	412 (5.68%)
9th through 12th Grade	286 (3.94%)
High School Diploma	1,602 (22.07%)
Some College/2-year	994 (13.7%)
B.S./B.A. (Bachelor of Science/Bachelor of Arts) or More	2,803 (38.62%)



Detailed Facility Report

Facility Summary

AGOSTO TIRE CENTER & SERVICE STATION

RD 3 KM 16.1, CANOVANAS, PR 00729

FRS (Facility Registry Service) ID: 110007814749

EPA Region: 02

Latitude: 18.37652

Longitude: -65.913955

Locational Data Source: RCRAINFO

Industries: --

Indian Country: N

Enforcement and Compliance Summary

Statute	RCRA
Compliance Monitoring Activities (5 years)	--
Date of Last Compliance Monitoring Activity	10/21/1996
Compliance Status	No Violation Identified
Qtrs in Noncompliance (of 12)	0
Qtrs with Significant Violation	0
Informal Enforcement Actions (5 years)	--
Formal Enforcement Actions (5 years)	--
Penalties from Formal Enforcement Actions (5 years)	--
EPA Cases (5 years)	--
Penalties from EPA Cases (5 years)	--

Regulatory Information

Clean Air Act (CAA): No Information

Clean Water Act (CWA): No Information

Resource Conservation and Recovery Act (RCRA): Inactive Other, (PRO007001597)

Safe Drinking Water Act (SDWA): No Information

Go To Enforcement/Compliance Details

Known Data Problems <<https://epa.gov/resources/echo-data/known-data-problems>>

Other Regulatory Reports

Air Emissions Inventory (EIS): No Information

Greenhouse Gas Emissions (eGGRT): No Information

Toxic Releases (TRI): No Information

Compliance and Emissions Data Reporting Interface (CEDRI): No Information

Facility/System Characteristics

Facility/System Characteristics

System	Statute	Identifier	Universe	Status	Areas	Permit Expiration Date	Indian Country	Latitude	Longitude
FRS		110007814749					N	18.37652	-65.913955
RCRAInfo	RCRA	PRO007001597	Other	Inactive ()			N		

Facility Address

System	Statute	Identifier	Facility Name	Facility Address	Facility County
FRS		110007814749	AGOSTO TIRE CENTER & SERVICE STATION	RD 3 KM 16.1, CANOVANAS, PR 00729	Canóvanas Municipio
RCRAInfo	RCRA	PRO007001597	AGOSTO TIRE CENTER & SERVICE STATION	RD 3 KM 16.1, CANOVANAS, PR 00729	Canóvanas Municipio

Facility SIC (Standard Industrial

Facility NAICS (North American Industry

Classification) Codes

System	Identifier	SIC Code	SIC Description
No data records returned			

Classification System) Codes

System	Identifier	NAICS Code	NAICS Description
No data records returned			

Facility Tribe Information

Reservation Name	Tribe Name	EPA Tribal ID	Distance to Tribe (miles)
No data records returned			

Enforcement and Compliance

Compliance Monitoring History Last 5 Years

Statute	Source ID	System	Activity Type	Compliance Monitoring Type	Lead Agency	Date	Finding (if applicable)
No data records returned							

Entries in italics are not included in ECHO's Compliance Monitoring Activity counts because they are not compliance monitoring strategy <<https://www.epa.gov/compliance/compliance-monitoring-programs>> activities or because they are not counted as inspections within EPA's Annual Results <<https://www.epa.gov/enforcement/enforcement-data-and-results>>.

Compliance Summary Data

Statute	Source ID	Current SNC (Significant Noncompliance)/HPV (High Priority Violation)	Current As Of	Qtrs with NC (Noncompliance) (of 12)	Data Last Refreshed
RCRA	PRO007001597	No	10/19/2024	0	10/18/2024

Three-Year Compliance History by Quarter

Statute	Program/Pollutant/Violation Type	QTR 1	QTR 2	QTR 3	QTR 4	QTR 5	QTR 6	QTR 7	QTR 8	QTR 9	QTR 10	QTR 11	QTR 12+
RCRA (Source ID: PRO007001597)		10/01-12/31/21	01/01-03/31/22	04/01-06/30/22	07/01-09/30/22	10/01-12/31/22	01/01-03/31/23	04/01-06/30/23	07/01-09/30/23	10/01-12/31/23	01/01-03/31/24	04/01-06/30/24	07/01-09/30/24
	Facility-Level Status	No Violation Identified	No Violation Identified	No Violation Identified	No Violation Identified	No Violation Identified	No Violation Identified	No Violation Identified	No Violation Identified	No Violation Identified	No Violation Identified	No Violation Identified	No Violation Identified
	Violation												
	Agency												

Informal Enforcement Actions Last 5 Years

Statute	System	Source ID	Type of Action	Lead Agency	Date
No data records returned					

Entries in italics are not counted as "informal enforcement actions" in EPA policies pertaining to enforcement response tools.

Formal Enforcement Actions Last 5 Years

Statute	System	Law/Section	Source ID	Type of Action	Case No.	Lead Agency	Case Name	Issued/ Filed Date	Settlements/ Actions	Settlement/ Action Date	Federal Penalty Assessed	State/ Local Penalty Assessed	Penalty Amount Collected	SEP Value	Comp Action Cost
No data records returned															

Environmental Conditions

Watersheds

12-Digit WBD (Watershed Boundary Dataset) HUC (RAD (Reach Address Database))	WBD (Watershed Boundary Dataset) Subwatershed Name (RAD (Reach Address Database))	State Water Body Name (ICIS (Integrated Compliance Information System))	Beach Closures Within Last Year	Beach Closures Within Last Two Years	Pollutants Potentially Related to Impairment	Watershed with ESA (Endangered Species Act)-listed Aquatic Species?
No data records returned						

Assessed Waters From Latest State Submission (ATTAINS)

State	Report Cycle	Assessment Unit ID	Assessment Unit Name	Water Condition	Cause Groups Impaired	Drinking Water Use	Ecological Use	Fish Consumption Use	Recreation Use	Other Use
No data records returned										

Air Quality Nonattainment Areas

Pollutant	Within Nonattainment Status Area?	Nonattainment Status Applicable Standard(s)	Within Maintenance Status Area?	Maintenance Status Applicable Standard(s)
No data records returned				

Pollutants

Toxics Release Inventory History of Reported Chemicals Released or Transferred in Pounds per

Year at Site ⓘ

TRI Facility ID | Year | Air Emissions | Surface Water Discharges | Off-Site Transfers to POTWs (Publicly Owned Treatment Works) | Underground Injections | Disposal to Land | Total On-Site Releases | Total Off-Site Transfers

No data records returned

Toxics Release Inventory Total Releases and Transfers in Pounds by Chemical and Year ⓘ

Chemical Name

No data records returned

Community

Environmental Justice

This section shows indexes from EJScreen, EPA's screening tool for environmental justice (EJ) concerns. EPA uses these indexes to identify geographic areas that may warrant further consideration or analysis for potential EJ concerns. Use of these indexes does not designate an area as an "EJ community" or "EJ facility." EJScreen provides screening level indicators, not a determination of the existence or absence of EJ concerns. For more information, see the EJScreen home page.



Potential Environmental Justice Concerns

- US Territory
- Supplemental/EJ index percentiles >= 90 (Census block group)
- Supplemental/EJ index percentiles >= 90 (1-mile average)

EJScreen Indexes Shown

Index Type

Supplemental (default) ⌵

Related Reports

EJScreen Community Report

[Download Data](#)

Supplemental Indexes	US (Percentile)			State (Percentile)		
	Facility Census Block Group	1-mile Avg	1-mile Max	Facility Census Block Group	1-mile Avg	1-mile Max
Count of Indexes At or Above 90th Percentile	7	5	7	0	0	4
Particulate Matter 2.5	--	N/A	--	--	N/A	--
Ozone	--	N/A	--	--	N/A	--
Diesel Particulate Matter	4	6	20	40	37	67
Air Toxics Cancer Risk	52	34	56	49	0	94
Air Toxics Respiratory Hazard Index	34	32	41	50	38	93
Toxic Releases to Air	99	98	99	83	70	97
Traffic Proximity	99	97	99	78	63	96
Lead Paint	97	62	99	77	25	94
Risk Management Plan (RMP) Facility Proximity	68	69	88	20	22	43
Hazardous Waste Proximity	93	93	99	59	64	92
Superfund Proximity	94	92	98	36	34	44
Underground Storage Tanks (UST)	92	45	99	72	0	92
Wastewater Discharge	98	91	99	59	31	89

Map Display Based on: US State

Display Map Layer

Summary - Number of Indexes ⌵

Facility 1-mile Radius Facility Census Block Group



Demographic Profile of Surrounding Area (1-Mile Radius)

This section provides demographic information regarding the community surrounding the facility. ECHO compliance data alone are not sufficient to determine whether violations at a particular facility had negative impacts on public health or the environment. Statistics are based upon the 2021 American Community Survey (ACS) 5-year Summary and are accurate to the extent that the facility latitude and longitude listed below are correct. Census boundaries and demographic data for U.S. Territories are based on the "2020 Island Areas Demographic Profiles" from the U.S. Census Bureau. EPA's spatial processing methodology considers the overlap between the selected radii and ACS census block groups in determining the demographics surrounding the facility. For more detail about this methodology, see the DFR Data Dictionary <<https://epa.gov/help/reports/dfr-data-dictionary#demographic>>.

General Statistics (ACS (American Community Survey))	
Total Persons	9,726
Population Density	3,181/sq.mi.
Housing Units in Area	3,866
Percent People of Color	100%
Households in Area	3,347
Households on Public Assistance	140
Persons With Low Income	5,780
Percent With Low Income	60%

Geography	
Radius of Selected Area	1 mi.
Center Latitude	18.37652
Center Longitude	-65.913955
Land Area	98%
Water Area	2%

Income Breakdown (ACS (American Community Survey)) - Households (%)	
Less than \$15,000	722 (21.57%)
\$15,000 - \$25,000	557 (16.64%)
\$25,000 - \$50,000	904 (27%)
\$50,000 - \$75,000	556 (16.61%)
Greater than \$75,000	609 (18.19%)

Age Breakdown (ACS (American Community Survey)) - Persons (%)	
Children 5 years and younger	292 (3%)
Minors 17 years and younger	1,659 (17%)
Adults 18 years and older	8,068 (83%)
Seniors 65 years and older	1,825 (19%)

Race Breakdown (ACS (American Community Survey)) - Persons (%)	
White	3,778 (39%)
African-American	0 (0%)
Hispanic-Origin	9,723 (100%)
Asian	0 (0%)
Hawaiian/Pacific Islander	0 (0%)
American Indian	0 (0%)
Other/Multiracial	2,956 (30%)

Education Level (Persons 25 & older) (ACS (American Community Survey)) - Persons (%)	
Less than 9th Grade	427 (6.06%)
9th through 12th Grade	387 (5.49%)
High School Diploma	1,937 (27.49%)
Some College/2-year	867 (12.31%)
B.S./B.A. (Bachelor of Science/Bachelor of Arts) or More	2,527 (35.87%)



Detailed Facility Report

Facility Summary

HIPODROMO CAMARERO

STATE RD 3 KM 15.3, CANOVANAS, PR 00729

FRS (Facility Registry Service) ID: 110032966645

EPA Region: 02

Latitude: 18.376349

Longitude: -65.910913

Locational Data Source: RCRAINFO

Industries: Performing Arts, Spectator Sports, and Related Industries

Indian Country: N

Enforcement and Compliance Summary

Statute	RCRA
Compliance Monitoring Activities (5 years)	--
Date of Last Compliance Monitoring Activity	11/14/2007
Compliance Status	No Violation Identified
Qtrs in Noncompliance (of 12)	0
Qtrs with Significant Violation	0
Informal Enforcement Actions (5 years)	--
Formal Enforcement Actions (5 years)	--
Penalties from Formal Enforcement Actions (5 years)	--
EPA Cases (5 years)	--
Penalties from EPA Cases (5 years)	--

Regulatory Information

Clean Air Act (CAA): No Information

Clean Water Act (CWA): No Information

Resource Conservation and Recovery Act (RCRA): Active SQG, (PRR000021196)

Safe Drinking Water Act (SDWA): No Information

Go To Enforcement/Compliance Details

Known Data Problems <<https://epa.gov/resources/echo-data/known-data-problems>>

Other Regulatory Reports

Air Emissions Inventory (EIS): No Information

Greenhouse Gas Emissions (eGGRT): No Information

Toxic Releases (TRI): No Information

Compliance and Emissions Data Reporting Interface (CEDRI): No Information

Facility/System Characteristics

Facility/System Characteristics

System	Statute	Identifier	Universe	Status	Areas	Permit Expiration Date	Indian Country	Latitude	Longitude
FRS		110032966645					N	18.376349	-65.910913
RCRAInfo	RCRA	PRR000021196	SQG	Active (H)			N	18.376349	-65.910913

Facility Address

System	Statute	Identifier	Facility Name	Facility Address	Facility County
FRS		110032966645	HIPODROMO CAMARERO	STATE RD 3 KM 15.3, CANOVANAS, PR 00729	Canóvanas Municipio
RCRAInfo	RCRA	PRR000021196	HIPODROMO CAMARERO	STATE RD 3 KM 15.3, CANOVANAS, PR 00729	Canóvanas Municipio

Facility SIC (Standard Industrial

Facility NAICS (North American Industry

Classification) Codes

System	Identifier	SIC Code	SIC Description
No data records returned			

Classification System) Codes

System	Identifier	NAICS Code	NAICS Description
RCRAInfo	PRR000021196	711212	Racetacks

Facility Tribe Information

Reservation Name	Tribe Name	EPA Tribal ID	Distance to Tribe (miles)
No data records returned			

Enforcement and Compliance

Compliance Monitoring History Last 5 Years

Statute	Source ID	System	Activity Type	Compliance Monitoring Type	Lead Agency	Date	Finding (if applicable)
No data records returned							

Entries in italics are not included in ECHO's Compliance Monitoring Activity counts because they are not compliance monitoring strategy <<https://www.epa.gov/compliance/compliance-monitoring-programs>> activities or because they are not counted as inspections within EPA's Annual Results <<https://www.epa.gov/enforcement/enforcement-data-and-results>>.

Compliance Summary Data

Statute	Source ID	Current SNC (Significant Noncompliance)/HPV (High Priority Violation)	Current As Of	Qtrs with NC (Noncompliance) (of 12)	Data Last Refreshed
RCRA	PRR000021196	No	10/19/2024	0	10/18/2024

Three-Year Compliance History by Quarter

Statute	Program/Pollutant/Violation Type	QTR 1	QTR 2	QTR 3	QTR 4	QTR 5	QTR 6	QTR 7	QTR 8	QTR 9	QTR 10	QTR 11	QTR 12+
RCRA (Source ID: PRR000021196)		10/01-12/31/21	01/01-03/31/22	04/01-06/30/22	07/01-09/30/22	10/01-12/31/22	01/01-03/31/23	04/01-06/30/23	07/01-09/30/23	10/01-12/31/23	01/01-03/31/24	04/01-06/30/24	07/01-09/30/24
	Facility-Level Status	No Violation Identified	No Violation Identified	No Violation Identified	No Violation Identified	No Violation Identified	No Violation Identified	No Violation Identified	No Violation Identified	No Violation Identified	No Violation Identified	No Violation Identified	No Violation Identified
	Violation												
	Agency												

Informal Enforcement Actions Last 5 Years

Statute	System	Source ID	Type of Action	Lead Agency	Date
No data records returned					

Entries in italics are not counted as "informal enforcement actions" in EPA policies pertaining to enforcement response tools.

Formal Enforcement Actions Last 5 Years

Statute	System	Law/Section	Source ID	Type of Action	Case No.	Lead Agency	Case Name	Issued/ Filed Date	Settlements/ Actions	Settlement/ Action Date	Federal Penalty Assessed	State/ Local Penalty Assessed	Penalty Amount Collected	SEP Value	Comp Action Cost
No data records returned															

Environmental Conditions

Watersheds

12-Digit WBD (Watershed Boundary Dataset) HUC (Reach Address Database)	WBD (Watershed Boundary Dataset) Subwatershed Name (RAD (Reach Address Database))	State Water Body Name (ICIS (Integrated Compliance Information System))	Beach Closures Within Last Year	Beach Closures Within Last Two Years	Pollutants Potentially Related to Impairment	Watershed with ESA (Endangered Species Act)-listed Aquatic Species?
No data records returned						

Assessed Waters From Latest State Submission (ATTAINS)

State	Report Cycle	Assessment Unit ID	Assessment Unit Name	Water Condition	Cause Groups Impaired	Drinking Water Use	Ecological Use	Fish Consumption Use	Recreation Use	Other Use
No data records returned										

Air Quality Nonattainment Areas

Pollutant	Within Nonattainment Status Area?	Nonattainment Status Applicable Standard(s)	Within Maintenance Status Area?	Maintenance Status Applicable Standard(s)
No data records returned				

Pollutants

Toxics Release Inventory History of Reported Chemicals Released or Transferred in Pounds per Year at Site

TRI Facility ID	Year	Air Emissions	Surface Water Discharges	Off-Site Transfers to POTWs (Publicly Owned Treatment Works)	Underground Injections	Disposal to Land	Total On-Site Releases	Total Off-Site Transfers
-----------------	------	---------------	--------------------------	--	------------------------	------------------	------------------------	--------------------------

No data records returned

Toxics Release Inventory Total Releases and Transfers in Pounds by Chemical and Year ⓘ

Chemical Name

No data records returned

e-Manifest Hazardous Waste History (Public)

Hazardous Waste Shipped in Kilograms by Year (Through 20/7/2024)

Source ID	Waste Description	2021	2022	2023	2024
PRR00021196	Hazardous Waste	731	1,052	1,184	498
PRR00021196	Acute Hazardous Waste	0	0	0	0
PRR00021196	Pharmaceutical Hazardous Waste	0	0	0	0

"Pharmaceutical Hazardous Waste" refers to quantities managed under 40 CFR part 266 subpart P and thus excluded from the Hazardous and Acute Hazardous Waste quantities shown above.

Community

Environmental Justice

This section shows indexes from EJScreen, EPA's screening tool for environmental justice (EJ) concerns. EPA uses these indexes to identify geographic areas that may warrant further consideration or analysis for potential EJ concerns. Use of these indexes does not designate an area as an "EJ community" or "EJ facility." EJScreen provides screening level indicators, not a determination of the existence or absence of EJ concerns. For more information, see the EJScreen home page.



Potential Environmental Justice Concerns

- US Territory
- Supplemental/EJ index percentiles >= 90 (Census block group)
- Supplemental/EJ index percentiles >= 90 (1-mile average)

EJScreen Indexes Shown

Index Type

Supplemental (default) ⬇

Related Reports

EJScreen Community Report

[Download Data](#)

Supplemental Indexes	US (Percentile)			State (Percentile)		
	Facility Census Block Group	1-mile Avg	1-mile Max	Facility Census Block Group	1-mile Avg	1-mile Max
Count of Indexes At or Above 90th Percentile	7	5	7	0	0	4
Particulate Matter 2.5	--	N/A	--	--	N/A	--
Ozone	--	N/A	--	--	N/A	--
Diesel Particulate Matter	4	5	9	40	35	56
Air Toxics Cancer Risk	52	34	57	49	0	ⓘ 96
Air Toxics Respiratory Hazard Index	34	32	43	50	37	ⓘ 96
Toxic Releases to Air	ⓘ 99	ⓘ 98	ⓘ 99	83	71	ⓘ 99
Traffic Proximity	ⓘ 99	ⓘ 97	ⓘ 99	78	65	ⓘ 96
Lead Paint	ⓘ 97	65	ⓘ 99	77	27	ⓘ 94
Risk Management Plan (RMP) Facility Proximity	68	67	86	20	20	40
Hazardous Waste Proximity	ⓘ 93	ⓘ 92	ⓘ 99	59	60	ⓘ 92
Superfund Proximity	ⓘ 94	ⓘ 92	ⓘ 99	36	34	44
Underground Storage Tanks (UST)	ⓘ 92	64	ⓘ 99	72	0	ⓘ 94
Wastewater Discharge	ⓘ 98	ⓘ 93	ⓘ 99	59	36	89

Map Display Based on: US State

Display Map Layer

Summary - Number of Indexes ⬇

Facility 1-mile Radius Facility Census Block Group

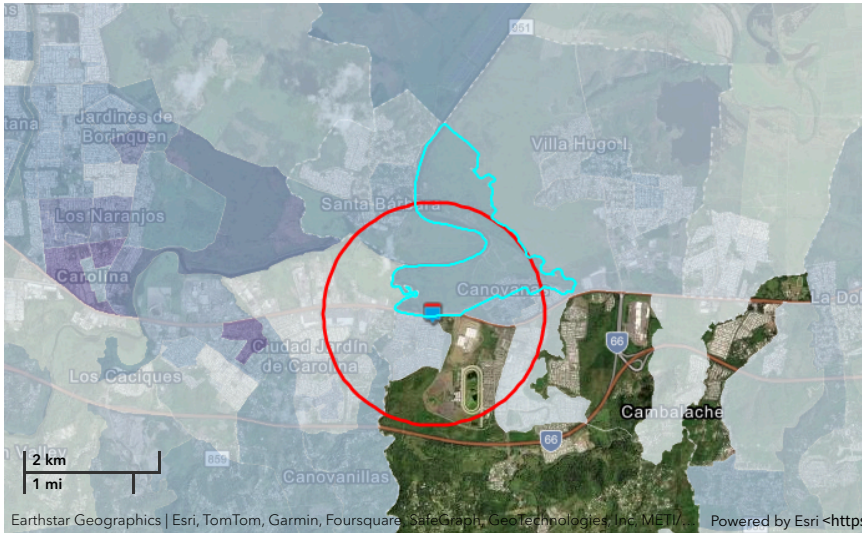

Demographic Profile of Surrounding Area (1-Mile Radius)

This section provides demographic information regarding the community surrounding the facility. ECHO compliance data alone are not sufficient to determine whether violations at a particular facility had negative impacts on public health or the environment. Statistics are based upon the 2021 American Community Survey (ACS) 5-year Summary and are accurate to the extent that the facility latitude and longitude listed below are correct. Census boundaries and demographic data for U.S. Territories are based on the "2020 Island Areas Demographic Profiles" from the U.S. Census Bureau. EPA's spatial processing methodology considers the overlap between the selected radii and ACS census block groups in determining the demographics surrounding the facility. For more detail about this methodology, see the DFR Data Dictionary <<https://epa.gov/help/reports/dfr-data-dictionary#demographic>>.

General Statistics (ACS (American Community Survey))	
Total Persons	9,873
Population Density	3,226/sq.mi.
Housing Units in Area	3,909
Percent People of Color	100%
Households in Area	3,364
Households on Public Assistance	146
Persons With Low Income	5,887
Percent With Low Income	60%

Geography	
Radius of Selected Area	1 mi.
Center Latitude	18.376349
Center Longitude	-65.910913
Land Area	98%
Water Area	2%

Income Breakdown (ACS (American Community Survey)) - Households (%)	
Less than \$15,000	713 (21.2%)
\$15,000 - \$25,000	553 (16.44%)
\$25,000 - \$50,000	930 (27.65%)
\$50,000 - \$75,000	551 (16.38%)
Greater than \$75,000	616 (18.32%)

Age Breakdown (ACS (American Community Survey)) - Persons (%)	
Children 5 years and younger	313 (3%)
Minors 17 years and younger	1,753 (18%)
Adults 18 years and older	8,117 (82%)
Seniors 65 years and older	1,777 (18%)

Race Breakdown (ACS (American Community Survey)) - Persons (%)	
White	3,740 (38%)
African-American	0 (0%)
Hispanic-Origin	9,857 (100%)
Asian	0 (0%)
Hawaiian/Pacific Islander	0 (0%)
American Indian	0 (0%)
Other/Multiracial	3,055 (31%)

Education Level (Persons 25 & older) (ACS (American Community Survey)) - Persons (%)	
Less than 9th Grade	456 (6.4%)
9th through 12th Grade	382 (5.37%)
High School Diploma	1,891 (26.56%)
Some College/2-year	903 (12.68%)
B.S./B.A. (Bachelor of Science/Bachelor of Arts) or More	2,506 (35.2%)

Sites in the National Priorities List

Obtained from <https://www.epa.gov/superfund/national-priorities-list-npl-sites-state> Site visited on August 3, 2024 (page was last updated on October 23, 2023)

Puerto Rico (19 sites)							
Site Name	City	Site EPA ID	Listing Date	Site Score	Federal Facility Indicator	Additional Information	Site Location
Atlantic Fleet Weapons Training Area - Vieques	Vieques	PRN000204694	02/11/2005		Yes	<ul style="list-style-type: none"> Site Listing Narrative Site Progress Profile Federal Register Notice (PDF) (8 pp, 175 K) 	Site Location
Cabo Rojo Ground Water Contamination	Cabo Rojo	PRN000206319	03/10/2011	50.00	No	<ul style="list-style-type: none"> Site Listing Narrative Site Progress Profile Federal Register Notice (PDF) (9 pp, 179 K) 	Site Location
Cidra Ground Water Contamination	Cidra	PRN000204538	07/22/2004	50.00	No	<ul style="list-style-type: none"> Site Listing Narrative Site Progress Profile Federal Register Notice (PDF) (8 pp, 205 K) 	Site Location
Corozal Well	Corozal	PRN000206452	03/15/2012	50.00	No	<ul style="list-style-type: none"> Site Listing Narrative Site Progress Profile Federal Register Notice (PDF) (9 pp, 250 K) 	Site Location
Dorado Ground Water Contamination	Dorado	PRN000201872	09/09/2016	50.00	No	<ul style="list-style-type: none"> Site Listing Narrative Site Progress Profile Federal Register Notice (PDF) (7 pp, 245 K) 	Site Location
Fibers Public Supply Wells	Jobos	PRD980763783	09/21/1984	35.34	No	<ul style="list-style-type: none"> Site Listing Narrative Site Progress Profile Federal Register Notice (PDF) (22 pp, 177 K) 	Site Location

Puerto Rico (19 sites)							
Site Name	City	Site EPA ID	Listing Date	Site Score	Federal Facility Indicator	Additional Information	Site Location
Juncos Landfill	Juncos	PRD980512362	09/08/1983	32.57	No	<ul style="list-style-type: none"> • Site Listing Narrative • Site Progress Profile • Federal Register Notice (PDF) (36 pp, 441 K) 	Site Location
Maunabo Area Ground Water Contamination	Maunabo	PRN000205831	09/27/2006	50.00	No	<ul style="list-style-type: none"> • Site Listing Narrative • Site Progress Profile • Federal Register Notice (PDF) (9 pp, 212 K) 	Site Location
Ochoa Fertilizer Co	Guanica	PRD091171264	09/09/2022	56.15	No	<ul style="list-style-type: none"> • Site Listing Narrative • Site Progress Profile • Federal Register Notice (PDF) (7 pp, 245 K) 	Site Location
Papelera Puertorriquena, Inc.	Utua	PRD090290685	09/23/2009	34.69	No	<ul style="list-style-type: none"> • Site Listing Narrative • Site Progress Profile • Federal Register Notice (PDF) (10 pp, 170 K) 	Site Location
Pesticide Warehouse I	Arecibo	PRD987367349	09/27/2006	50.00	No	<ul style="list-style-type: none"> • Site Listing Narrative • Site Progress Profile • Federal Register Notice (PDF) (9 pp, 212 K) 	Site Location
Pesticide Warehouse III	Manati	PRD987367299	04/30/2003	50.00	No	<ul style="list-style-type: none"> • Site Listing Narrative • Site Progress Profile • Federal Register Notice (PDF) (8 pp, 191 K) 	Site Location
PROTECO	Peñuelas	PRD000831487	05/15/2019	36.33	No	<ul style="list-style-type: none"> • Site Listing Narrative • Site Progress Profile • Federal Register Notice (PDF) (7 pp, 324 K) 	Site Location

Puerto Rico (19 sites)							
Site Name	City	Site EPA ID	Listing Date	Site Score	Federal Facility Indicator	Additional Information	Site Location
San German Ground Water Contamination	San German	PRN000205957	03/19/2008	50.00	No	<ul style="list-style-type: none"> • Site Listing Narrative • Site Progress Profile • Federal Register Notice (PDF) (9 pp, 214 K) 	Site Location
Scorpio Recycling, Inc.	Candeleria Ward	PRD987376662	02/04/2000	50.00	No	<ul style="list-style-type: none"> • Site Listing Narrative • Site Progress Profile • Federal Register Notice (PDF) (8 pp, 271 K) 	Site Location
The Battery Recycling Company	Bo. Cambalache	PRR000004655	08/03/2017	56.66	No	<ul style="list-style-type: none"> • Site Listing Narrative • Site Progress Profile • Federal Register Notice (PDF) (6 pp, 255 K) 	Site Location
Upjohn Facility	Barceloneta	PRD980301154	09/21/1984	41.92	No	<ul style="list-style-type: none"> • Site Listing Narrative • Site Progress Profile • Federal Register Notice (PDF) (22 pp, 177 K) 	Site Location
Vega Alta Public Supply Wells	Vega Alta	PRD980763775	09/21/1984	42.24	No	<ul style="list-style-type: none"> • Site Listing Narrative • Site Progress Profile • Federal Register Notice (PDF) (22 pp, 177 K) 	Site Location
Vega Baja Solid Waste Disposal	Rio Abajo Ward	PRD980512669	07/22/1999	50.37	No	<ul style="list-style-type: none"> • Site Listing Narrative • Site Progress Profile • Federal Register Notice (PDF) (8 pp, 183 K) 	Site Location



Detailed Facility Report

Facility Summary

CENTRO DE DISTRIBUCION - SUPERMERCADOS ECONO, INC.

PR-3, INT. PR-9959, KM 15.21, CANOVANILLAS WARD, CANOVANAS, PR 00729

FRS (Facility Registry Service) ID: 110071222992

EPA Region: 02

Latitude: 18.375719

Longitude: -65.906789

Locational Data Source: NPDES

Industries: --

Indian Country: N

Enforcement and Compliance Summary

Statute	CWA
Compliance Monitoring Activities (5 years)	--
Date of Last Compliance Monitoring Activity	--
Compliance Status	No Violation Identified
Qtrs in Noncompliance (of 12)	0
Qtrs with Significant Violation	0
Informal Enforcement Actions (5 years)	--
Formal Enforcement Actions (5 years)	--
Penalties from Formal Enforcement Actions (5 years)	--
EPA Cases (5 years)	--
Penalties from EPA Cases (5 years)	--

Regulatory Information

Clean Air Act (CAA): No Information

Clean Water Act (CWA): Non-Major, Permit Effective (PRR05J02S)

Resource Conservation and Recovery Act (RCRA): No Information

Safe Drinking Water Act (SDWA): No Information

Other Regulatory Reports

Air Emissions Inventory (EIS): No Information

Greenhouse Gas Emissions (eGGR): No Information

Toxic Releases (TRI): No Information

Compliance and Emissions Data Reporting Interface (CEDRI): No Information

Go To Enforcement/Compliance Details

Known Data Problems <<https://epa.gov/resources/echo-data/known-data-problems>>

Facility/System Characteristics

Facility/System Characteristics

System	Statute	Identifier	Universe	Status	Areas	Permit Expiration Date	Indian Country	Latitude	Longitude
FRS		110071222992					N	18.375719	-65.906789
ICIS-NPDES	CWA	PRR05J02S	Non-Major: General Permit Covered Facility	Effective	Industrial Stormwater	02/28/2026	N	18.373567	-65.906283

Facility Address

System	Statute	Identifier	Facility Name	Facility Address	Facility County
FRS		110071222992	CENTRO DE DISTRIBUCION - SUPERMERCADOS ECONO, INC.	PR-3, INT. PR-9959, KM 15.21, CANOVANILLAS WARD, CANOVANAS, PR 00729	Canóvanas Municipio
ICIS-NPDES	CWA	PRR05J02S	CENTRO DE DISTRIBUCION - SUPERMERCADOS ECONO, INC.	PR-3, INT. PR-9959, KM 15.21, CANOVANILLAS WARD, CANOVANAS, PR 00729	

Facility SIC (Standard Industrial Classification) Codes

System	Identifier	SIC Code	SIC Description
ICIS-NPDES	PRR05J02S	4222	Refrigerated Warehousing And Storage
ICIS-NPDES	PRR05J02S	4225	General Warehousing And Storage

Facility NAICS (North American Industry Classification System) Codes

System	Identifier	NAICS Code	NAICS Description
No data records returned			

Facility Industrial Effluent Guidelines

Identifier	Effluent Guideline (40 CFR Part)	Effluent Guideline Description
No data records returned		

Facility Tribe Information

Reservation Name	Tribe Name	EPA Tribal ID	Distance to Tribe (miles)
No data records returned			

Enforcement and Compliance

Compliance Monitoring History Last 5 Years

Statute	Source ID	System	Activity Type	Compliance Monitoring Type	Lead Agency	Date	Finding (if applicable)
No data records returned							

Entries in italics are not included in ECHO's Compliance Monitoring Activity counts because they are not compliance monitoring strategy <<https://www.epa.gov/compliance/compliance-monitoring-programs>> activities or because they are not counted as inspections within EPA's Annual Results <<https://www.epa.gov/enforcement/enforcement-data-and-results>>.

Compliance Summary Data

Statute	Source ID	Current SNC (Significant Noncompliance)/HPV (High Priority Violation)	Current As Of	Qtrs with NC (Noncompliance) (of 12)	Data Last Refreshed
CWA	PRR05J02S	No	03/31/2024	0	07/19/2024

Three-Year Compliance History by Quarter

Statute	Program/Pollutant/Violation Type	QTR 1	QTR 2	QTR 3	QTR 4	QTR 5	QTR 6	QTR 7	QTR 8	QTR 9	QTR 10	QTR 11
CWA	(Source ID: PRR05J02S)	04/01-06/30/21	07/01-09/30/21	10/01-12/31/21	01/01-03/31/22	04/01-06/30/22	07/01-09/30/22	10/01-12/31/22	01/01-03/31/23	04/01-06/30/23	07/01-09/30/23	10/01-12/31/23
	Facility-Level Status	No Violation Identified	No Violation Identified	No Violation Identified	No Violation Identified	No Violation Identified	No Violation Identified	No Violation Identified	No Violation Identified	No Violation Identified	No Violation Identified	No Violation Identified
	Quarterly Noncompliance Report History											

Informal Enforcement Actions Last 5 Years

Statute	System	Source ID	Type of Action	Lead Agency	Date
No data records returned					

Entries in italics are not counted as "informal enforcement actions" in EPA policies pertaining to enforcement response tools.

Formal Enforcement Actions Last 5 Years

Statute	System	Law/Section	Source ID	Type of Action	Case No.	Lead Agency	Case Name	Issued/ Filed Date	Settlements/ Actions	Settlement/ Action Date	Federal Penalty Assessed	State/ Local Penalty Assessed	Penalty Amount Collected	SEP Value	Comp Action Cost
No data records returned															

Environmental Conditions

Watersheds

12-Digit WBD (Watershed Boundary Dataset) HUC (RAD (Reach Address Database))	WBD (Watershed Boundary Dataset) Subwatershed Name (RAD (Reach Address Database))	State Water Body Name (ICIS (Integrated Compliance Information System))	Beach Closures Within Last Year	Beach Closures Within Last Two Years	Pollutants Potentially Related to Impairment	Watershed with ESA (Endangered Species Act)-listed Aquatic Species?
210100050414	Rio Grande de Loiza at mouth	BOCAFORMA CREEK WETLAND	No	No	--	Yes

Assessed Waters From Latest State Submission (ATTAINS)

State	Report Cycle	Assessment Unit ID	Assessment Unit Name	Water Condition	Cause Groups Impaired	Drinking Water Use	Ecological Use	Fish Consumption Use	Recreation Use	Other Use
PR	2022	PREE14A	RIO GRANDE DE LOIZA ESTUARY	Impaired - With Restoration Plan	PATHOGENS	--	Insufficient Information	--	Not Supporting	--

Air Quality Nonattainment Areas

Pollutant	Within Nonattainment Status Area?	Nonattainment Status Applicable Standard(s)	Within Maintenance Status Area?	Maintenance Status Applicable Standard(s)
No data records returned				

Pollutants

Toxics Release Inventory History of Reported Chemicals Released or Transferred in Pounds per Year at Site

TRI Facility ID	Year	Air Emissions	Surface Water Discharges	Off-Site Transfers to POTWs (Publicly Owned Treatment Works)	Underground Injections	Disposal to Land	Total On-Site Releases	Total Off-Site Transfers
No data records returned								

Toxics Release Inventory Total Releases and Transfers in Pounds by Chemical and Year

Chemical Name
No data records returned

CWA (Clean Water Act) Discharge Monitoring Report (DMR) Pollutant Loadings

DMR and TRI Multi-Year Loading Report

NPDES ID	Description
No data records returned	

Community

Environmental Justice

This section shows indexes from EJScreen, EPA's screening tool for environmental justice (EJ) concerns. EPA uses these indexes to identify geographic areas that may warrant further consideration or analysis for potential EJ concerns. Use of these indexes does not designate an area as an "EJ community" or "EJ facility." EJScreen provides screening level indicators, not a determination of the existence or absence of EJ concerns. For more information, see the EJScreen home page.

Potential Environmental Justice Concerns

- US Territory
- Supplemental/EJ index percentiles >= 90 (1-mile average)

EJScreen Indexes Shown

Index Type

Related Reports

EJScreen Community Report

Download Data

Census Block Group ID: 720291005041	US (Percentile)			State (Percentile)		
	Supplemental Indexes	Facility Census Block Group	1-mile Avg	1-mile Max	Facility Census Block Group	1-mile Avg
Count of Indexes At or Above 90th Percentile	0	5	7	0	0	4
Particulate Matter 2.5	--	N/A	--	--	N/A	--
Ozone	--	N/A	--	--	N/A	--
Diesel Particulate Matter	0	5	9	10	34	56
Air Toxics Cancer Risk	47	34	57	21	0	96
Air Toxics Respiratory Hazard Index	29	32	43	23	37	96
Toxic Releases to Air	89	98	99	42	73	99
Traffic Proximity	81	97	99	32	66	96
Lead Paint	43	61	99	20	25	94

Census Block Group ID: 720291005041	US (Percentile)			State (Percentile)		
	Facility Census Block Group	1-mile Avg	1-mile Max	Facility Census Block Group	1-mile Avg	1-mile Max
Risk Management Plan (RMP) Facility Proximity	49	65	86	12	19	38
Hazardous Waste Proximity	71	91	99	24	56	92
Superfund Proximity	84	92	99	28	34	44
Underground Storage Tanks (UST)	76	77	99	62	61	94
Wastewater Discharge	89	94	99	36	39	75

Map Display Based on: US State

Display Map Layer

Facility 1-mile Radius Facility Census Block Group



Demographic Profile of Surrounding Area (1-Mile Radius)

This section provides demographic information regarding the community surrounding the facility. ECHO compliance data alone are not sufficient to determine whether violations at a particular facility had negative impacts on public health or the environment. Statistics are based upon the 2010 U.S. Census and 2017 - 2021 American Community Survey (ACS) 5-year Summary and are accurate to the extent that the facility latitude and longitude listed below are correct. Census boundaries and demographic data for U.S. Territories are based on the "2020 Island Areas Demographic Profiles" from the U.S. Census Bureau. EPA's spatial processing methodology considers the overlap between the selected radii and the census blocks (for U.S. Census demographics) and census block groups (for ACS demographics) in determining the demographics surrounding the facility. For more detail about this methodology, see the DFR Data Dictionary <<https://epa.gov/help/reports/dfr-data-dictionary#demographic>>.

General Statistics (U.S. Census)	
Total Persons	9,200
Population Density	3,082/sq.mi.
Housing Units in Area	3,774

General Statistics (ACS (American Community Survey))	
Total Persons	10,600
Percent People of Color	100%
Households in Area	3,570
Households on Public Assistance	144
Persons With Low Income	6,320
Percent With Low Income	60%

Geography	
Radius of Selected Area	1 mi.

Age Breakdown (U.S. Census) - Persons (%)	
Children 5 years and younger	568 (6%)
Minors 17 years and younger	2,379 (26%)
Adults 18 years and older	6,821 (74%)
Seniors 65 years and older	1,316 (14%)

Race Breakdown (U.S. Census) - Persons (%)	
White	5,863 (64%)
African-American	1,965 (21%)
Hispanic-Origin	9,145 (99%)
Asian/Pacific Islander	20 (0%)
American Indian	58 (1%)
Other/Multiracial	1,295 (14%)

Geography	
Center Latitude	18.375719
Center Longitude	-65.906789
Land Area	98%
Water Area	2%
Income Breakdown (ACS (American Community Survey)) - Households (%)	
Less than \$15,000	723 (20.26%)
\$15,000 - \$25,000	596 (16.7%)
\$25,000 - \$50,000	1,046 (29.31%)
\$50,000 - \$75,000	555 (15.55%)
Greater than \$75,000	649 (18.18%)

Education Level (Persons 25 & older) (ACS (American Community Survey)) - Persons (%)	
Less than 9th Grade	497 (6.54%)
9th through 12th Grade	379 (4.99%)
High School Diploma	1,932 (25.41%)
Some College/2-year	996 (13.1%)
B.S./B.A. (Bachelor of Science/Bachelor of Arts) or More	2,667 (35.08%)

 An official website of the United States government

MENU

Search EPA.gov

You are here: EPA Home <[>>>](https://epa.gov/www.epa.gov/)**Cleanups**
<[>>](https://epa.gov/www.epa.gov/cleanups/)Cleanups In My Community (CIMC)

CONTACT US <<https://www.epa.gov/cleanups/forms/contact-us/>>

Property Details for TWO ADJACENT ABANDONED RESIDENCES (SITE 9-H)

On this page:

- Profile Information
- Property Location
- Property Progress
- CAs Associated with this Property
- Assessment Activities at this Property
- Climate Adaption and Mitigation - Planning or Assessment
- Contaminants and Media
- Cleanup Activities
- Climate Adaption and Mitigation - Demolition or Cleanup
- Institutional & Engineering Controls
- Redevelopment and Other Leveraged Accomplishments
- Climate Adaption and Mitigation - Redevelopment
- Additional Property Attributes

[Legal Notices](https://www.epa.gov/cleanups/cimc-legal-notice) <<https://www.epa.gov/cleanups/cimc-legal-notice>>

Profile Information

Property Alias	SITE 9-H
Property Owner	Government
ACRES Property ID	239395
Property Address	#76 & # 78 Pepita Albandoz Street Canóvanas, PR 00729
Size	.12
Parcel Numbers	
Latitude/Longitude	18.378073174550153 / -65.89985847473146
Congressional District	1
Property Contact	Pérez-Plaza, Lydia irizarryileana@hotmail.com 787-256-6878

[Top of Page](#)

Property Location

[Top of Page](#)

Property Progress

Assessment	✘
Clean Up	✘
Institutional Controls in Place	✘
Engineering Controls in Place	✘
Ready for Anticipated Use	✔
Redevelopment Underway	✘

[Top of Page](#)

CAs Associated with this Property

CA Name	CA #	State	Type	Announcement Year
Canovanas, Municipality of	BF97243208	PR	Assessment	2008

[Top of Page](#)

Assessment Activities at this Property

Activity	EPA Funding	Start Date	Completion Date	CA	Accomplishment Counted?	Counted When?
Phase I Environmental Assessment	\$4,731.00	11/21/2017	01/31/2018	Canovanas, Municipality of	Y	FY22

Is Cleanup Necessary? **No**EPA Assessment Funding: **\$4,731.00**

Leveraged Funding:
Total Funding: **\$4,731.00**

Top of Page

Climate Adaption and Mitigation - Planning or Assessment

There is no data for Climate Adaption and Mitigation - Planning or Assessment.

Top of Page

Contaminants and Media

Contaminant Found
Media Affected
Unknown

Remediating Action for Contaminants
Remediating Action for Media

Top of Page

Cleanup Activities

There are no current cleanup activities.

Cleanup/Treatment Implemented:
Cleanup/Treatment Categories:
Addl Cleanup/Treatment info:
Address of Data Source:

Top of Page

Climate Adaption and Mitigation - Demolition or Cleanup

There is no data for Climate Adaption and Mitigation - Demolition or Cleanup.

Top of Page

Institutional and Engineering Controls

Indicate whether Institutional Controls are required

Categories of Controls

Additional Institutional Controls Information

Address of Data Source (URL if available)

Are Institutional Controls in Place

Date Institutional Controls were put in place

Indicate whether Engineering Controls are required

Categories of Controls

Additional Engineering controls information

Address of Data Source (URL if available)

Indicate whether Engineering Controls are in place

Date Engineering Controls were put in place

[Top of Page](#)

Redevelopment and Other Leveraged Accomplishments

There are no current redevelopment activities.

Number of Redevelopment Jobs Leveraged:

Actual Acreage of Greenspace Created:

Leveraged Funding:

[Top of Page](#)

Climate Adaption and Mitigation - Redevelopment

There is no data for Climate Adaption and Mitigation - Redevelopment

[Top of Page](#)

Additional Property Attributes

Property Highlights	Former Use: The Subject Site has been used as residence for at least 45 years.
Predominant Past Usage	Residential (.12)
What types of funding are being used on this property?	Hazardous
State and Tribal Program Information	
Date No Further Action Letter Received	
Date Letter/Signed Report Received from a Qualified Professional	
Other Cleanup Documentation	

Top of Page



Discover.

Accessibility

<<https://www.epa.gov/accessibility>>

Budget & Performance

<<https://www.epa.gov/planning-budget>>

Contracting

<<https://www.epa.gov/contracting>>

EPA www Web Snapshots

<<https://www.epa.gov/home/wwwepagov-snapshots>>

Grants

<<https://www.epa.gov/grants>>

No FEAR Act Data

<<https://www.epa.gov/ocr/whistleblower-protections-epa-and-how-they-relate-non-disclosure-agreements-signed-epa-employees>>

Privacy

<<https://www.epa.gov/privacy>>

Connect.

Data.gov

<<https://www.data.gov/>>

Inspector General

<<https://www.epa.gov/office-inspector-general/about-epas-office-inspector-general>>

Jobs

<<https://www.epa.gov/careers>>

Newsroom

<<https://www.epa.gov/newsroom>>

Open Government

<<https://www.epa.gov/data>>

Regulations.gov

<<https://www.regulations.gov/>>

Subscribe

<<https://www.epa.gov/newsroom/email-subscriptions-epa-news-releases>>

USA.gov

<<https://www.usa.gov/>>

White House

<<https://www.whitehouse.gov/>>

Ask.

Contact EPA

<<https://www.epa.gov/aboutepa/forms/contact-epa>>

EPA Disclaimers

<<https://www.epa.gov/web-policies-and-procedures/epa-disclaimers>>

Hotlines

<<https://www.epa.gov/aboutepa/epa-hotlines>>

FOIA Requests

<<https://www.epa.gov/foia>>

Frequent Questions

<<https://www.epa.gov/aboutepa/frequent-questions-specific-epa-programtopics>>

Follow.



**Privacy and
Security Notice**

<<https://www.epa.gov/privacy-and-security-notice>>

Release 3.0.2

 An official website of the United States government

MENU

You are here: EPA Home <https://epa.gov/www.epa.gov/>>>**Cleanups**
<https://epa.gov/www.epa.gov/cleanups/>>>Cleanups In My Community (CIMC)

CONTACT US <https://www.epa.gov/cleanups/forms/contact-us/>

Property Details for Downtown's Old Dairy (Site 1-H)

On this page:

- Profile Information
- Property Location
- Property Progress
- CAs Associated with this Property
- Assessment Activities at this Property
- Climate Adaption and Mitigation - Planning or Assessment
- Contaminants and Media
- Cleanup Activities
- Climate Adaption and Mitigation - Demolition or Cleanup
- Institutional & Engineering Controls
- Redevelopment and Other Leveraged Accomplishments
- Climate Adaption and Mitigation - Redevelopment
- Additional Property Attributes

[Legal Notices <https://www.epa.gov/cleanups/cimc-legal-notice>](https://www.epa.gov/cleanups/cimc-legal-notice)

Profile Information

Property Alias	Site 1-H
Property Owner	Government
ACRES Property ID	239394
Property Address	Autonomous Street and Muñoz Rivera Street corner CANOVANAS, PR 00729
Size	.12
Parcel Numbers	089-086-017-08-901
Latitude/Longitude	18.37868327 / -65.90159636
Congressional District	1
Property Contact	Pérez-Plaza, Lydia irizarryileana@hotmail.com 787-256-6878

[Top of Page](#)

Property Location

[Top of Page](#)

Property Progress

Assessment	✘
Clean Up	✘
Institutional Controls in Place	✘
Engineering Controls in Place	✘
Ready for Anticipated Use	✔
Redevelopment Underway	✘

[Top of Page](#)

CAs Associated with this Property

CA Name	CA #	State	Type	Announcement Year
Canovanas, Municipality of	BF97243208	PR	Assessment	2008

[Top of Page](#)

Assessment Activities at this Property

Activity	EPA Funding	Start Date	Completion Date	CA	Accomplishment Counted?	Counted When?
Phase I Environmental Assessment	\$4,731.00	11/15/2017	01/30/2018	Canovanas, Municipality of	Y	FY22

Is Cleanup Necessary? **No**EPA Assessment Funding: **\$4,731.00**

Leveraged Funding:
Total Funding: **\$4,731.00**

Top of Page

Climate Adaption and Mitigation - Planning or Assessment

There is no data for Climate Adaption and Mitigation - Planning or Assessment.

Top of Page

Contaminants and Media

Contaminant Found
Media Affected
Unknown

Remediating Action for Contaminants
Remediating Action for Media

Top of Page

Cleanup Activities

There are no current cleanup activities.

Cleanup/Treatment Implemented:
Cleanup/Treatment Categories:
Addl Cleanup/Treatment info:
Address of Data Source:

Top of Page

Climate Adaption and Mitigation - Demolition or Cleanup

There is no data for Climate Adaption and Mitigation - Demolition or Cleanup.

Top of Page

Institutional and Engineering Controls

Indicate whether Institutional Controls are required

Categories of Controls

Additional Institutional Controls Information

Address of Data Source (URL if available)

Are Institutional Controls in Place

Date Institutional Controls were put in place

Indicate whether Engineering Controls are required

Categories of Controls

Additional Engineering controls information

Address of Data Source (URL if available)

Indicate whether Engineering Controls are in place

Date Engineering Controls were put in place

[Top of Page](#)

Redevelopment and Other Leveraged Accomplishments

There are no current redevelopment activities.

Number of Redevelopment Jobs Leveraged:

Actual Acreage of Greenspace Created:

Leveraged Funding:

[Top of Page](#)

Climate Adaption and Mitigation - Redevelopment

There is no data for Climate Adaption and Mitigation - Redevelopment

[Top of Page](#)

Additional Property Attributes

Property Highlights	Former Use: The history of the Subject Site occurs parallel to the development of the town around 1917 when cattle rancher Joselores Mundo built his dairy and warehouse on the site. Later on, the structure became an apothecary, the municipal's butcher shop, and dwelling of the Mundo PagFamily. The structure was abandoned in 1972.
Predominant Past Usage	Commercial (.12)
What types of funding are being used on this property?	Hazardous
State and Tribal Program Information	
Date No Further Action Letter Received	
Date Letter/Signed Report Received from a Qualified Professional	
Other Cleanup Documentation	

Top of Page



Discover.

Accessibility

<<https://www.epa.gov/accessibility>>

Budget & Performance

<<https://www.epa.gov/planning-budget>>

Contracting

<<https://www.epa.gov/contracts>>

EPA www Web Snapshots

<<https://www.epa.gov/home/wwepagov-snapshots>>

Grants

<<https://www.epa.gov/grants>>

No FEAR Act Data

<<https://www.epa.gov/ocr/whistleblower-protections-epa-and-how-they-relate-non-disclosure-agreements-signed-epa-employees>>

Privacy

<<https://www.epa.gov/privacy>>

Connect.

Data.gov

<<https://www.data.gov/>>

Inspector General

<<https://www.epa.gov/office-inspector-general/about-epas-office-inspector-general>>

Jobs

<<https://www.epa.gov/careers>>

Newsroom

<<https://www.epa.gov/newsroom>>

Open Government

<<https://www.epa.gov/data>>

Regulations.gov

<<https://www.regulations.gov/>>

Subscribe

<<https://www.epa.gov/newsroom/email-subscriptions-epa-news-releases>>

USA.gov

<<https://www.usa.gov/>>

White House

<<https://www.whitehouse.gov/>>

Ask.

Contact EPA

<<https://www.epa.gov/about-epa/forms/contact-epa>>

EPA Disclaimers

<<https://www.epa.gov/web-policies-and-procedures/epa-disclaimers>>

Hotlines

<<https://www.epa.gov/about-epa/epa-hotlines>>

FOIA Requests

<<https://www.epa.gov/foia>>

Frequent Questions

<<https://www.epa.gov/about-epa/frequent-questions-specific-epa-programstotics>>

Follow.



**Privacy and
Security Notice**

<<https://www.epa.gov/privacy-and-security-notice>>

Release 3.0.2



Detailed Facility Report

Facility Summary

ESCUELA LUIS HERNAIZ VERONE

CALLE AUTONOMIA, CANOVANAS, PR 00729

FRS (Facility Registry Service) ID: 110007811029

EPA Region: 02

Latitude: 18.377041

Longitude: -65.900862

Locational Data Source: RCRAINFO

Industries: --

Indian Country: N

Enforcement and Compliance Summary

Statute	RCRA
Compliance Monitoring Activities (5 years)	--
Date of Last Compliance Monitoring Activity	--
Compliance Status	No Violation Identified
Qtrs in Noncompliance (of 12)	0
Qtrs with Significant Violation	0
Informal Enforcement Actions (5 years)	--
Formal Enforcement Actions (5 years)	--
Penalties from Formal Enforcement Actions (5 years)	--
EPA Cases (5 years)	--
Penalties from EPA Cases (5 years)	--

Regulatory Information

Clean Air Act (CAA): No Information

Clean Water Act (CWA): No Information

Resource Conservation and Recovery Act (RCRA): Inactive Other, (PRD987373552)

Safe Drinking Water Act (SDWA): No Information

Other Regulatory Reports

Air Emissions Inventory (EIS): No Information

Greenhouse Gas Emissions (eGGRT): No Information

Toxic Releases (TRI): No Information

Compliance and Emissions Data Reporting Interface (CEDRI): No Information

Go To Enforcement/Compliance Details

Known Data Problems <<https://epa.gov/resources/echo-data/known-data-problems>>

Facility/System Characteristics

Facility/System Characteristics

System	Statute	Identifier	Universe	Status	Areas	Permit Expiration Date	Indian Country	Latitude	Longitude
FRS		110007811029					N	18.377041	-65.900862
RCRAInfo	RCRA	PRD987373552	Other	Inactive ()			N	18.377041	-65.900862

Facility Address

System	Statute	Identifier	Facility Name	Facility Address	Facility County
FRS		110007811029	ESCUELA LUIS HERNAIZ VERONE	CALLE AUTONOMIA, CANOVANAS, PR 00729	Canóvanas Municipio
RCRAInfo	RCRA	PRD987373552	ESCUELA LUIS HERNAIZ VERONE	CALLE AUTONOMIA, CANOVANAS, PR 00629	Canóvanas Municipio

Facility SIC (Standard Industrial Classification) Codes

System	Identifier	SIC Code	SIC Description
No data records returned			

Facility NAICS (North American Industry Classification System) Codes

System	Identifier	NAICS Code	NAICS Description
No data records returned			

Facility Tribe Information

Reservation Name	Tribe Name	EPA Tribal ID	Distance to Tribe (miles)
No data records returned			

Enforcement and Compliance

Compliance Monitoring History Last 5 Years

Statute	Source ID	System	Activity Type	Compliance Monitoring Type	Lead Agency	Date	Finding (if applicable)
No data records returned							

Entries in italics are not included in ECHO's Compliance Monitoring Activity counts because they are not compliance monitoring strategy <https://www.epa.gov/compliance/compliance-monitoring-programs> activities or because they are not counted as inspections within EPA's Annual Results <https://www.epa.gov/enforcement/enforcement-data-and-results>.

Compliance Summary Data

Statute	Source ID	Current SNC (Significant Noncompliance)/HPV (High Priority Violation)	Current As Of	Qtrs with NC (Noncompliance) (of 12)	Data Last Refreshed
RCRA	PRD987373552	No	07/20/2024	0	07/19/2024

Three-Year Compliance History by Quarter

Statute	Program/Pollutant/Violation Type	QTR 1	QTR 2	QTR 3	QTR 4	QTR 5	QTR 6	QTR 7	QTR 8	QTR 9	QTR 10	QTR 11
RCRA	(Source ID: PRD987373552)	10/01-12/31/21	01/01-03/31/22	04/01-06/30/22	07/01-09/30/22	10/01-12/31/22	01/01-03/31/23	04/01-06/30/23	07/01-09/30/23	10/01-12/31/23	01/01-03/31/24	04/01-06/30/24
	Facility-Level Status	No Violation Identified	No Violation Identified	No Violation Identified	No Violation Identified	No Violation Identified	No Violation Identified	No Violation Identified	No Violation Identified	No Violation Identified	No Violation Identified	No Violation Identified
	Violation Agency											

Informal Enforcement Actions Last 5 Years

Statute	System	Source ID	Type of Action	Lead Agency	Date
No data records returned					

Entries in italics are not counted as "informal enforcement actions" in EPA policies pertaining to enforcement response tools.

Formal Enforcement Actions Last 5 Years

Statute	System	Law/Section	Source ID	Type of Action	Case No.	Lead Agency	Case Name	Issued/Filed Date	Settlements/Actions	Settlement/Action Date	Federal Penalty Assessed	State/Local Penalty Assessed	Penalty Amount Collected	SEP Value	Comp Action Cost
No data records returned															

Environmental Conditions

Watersheds

12-Digit WBD (Watershed Boundary Dataset) HUC (RAD (Reach Address Database))	WBD (Watershed Boundary Dataset) Subwatershed Name (RAD (Reach Address Database))	State Water Body Name (ICIS (Integrated Compliance Information System))	Beach Closures Within Last Year	Beach Closures Within Last Two Years	Pollutants Potentially Related to Impairment	Watershed with ESA (Endangered Species Act)-listed Aquatic Species?
No data records returned						

Assessed Waters From Latest State Submission (ATTAINS)

State	Report Cycle	Assessment Unit ID	Assessment Unit Name	Water Condition	Cause Groups Impaired	Drinking Water Use	Ecological Use	Fish Consumption Use	Recreation Use	Other Use
-------	--------------	--------------------	----------------------	-----------------	-----------------------	--------------------	----------------	----------------------	----------------	-----------

No data records returned

Air Quality Nonattainment Areas

Pollutant	Within Nonattainment Status Area?	Nonattainment Status Applicable Standard(s)	Within Maintenance Status Area?	Maintenance Status Applicable Standard(s)
-----------	-----------------------------------	---	---------------------------------	---

No data records returned

Pollutants

Toxics Release Inventory History of Reported Chemicals Released or Transferred in Pounds per Year at Site

TRI Facility ID	Year	Air Emissions	Surface Water Discharges	Off-Site Transfers to POTWs (Publicly Owned Treatment Works)	Underground Injections	Disposal to Land	Total On-Site Releases	Total Off-Site Transfers
-----------------	------	---------------	--------------------------	--	------------------------	------------------	------------------------	--------------------------

No data records returned

Toxics Release Inventory Total Releases and Transfers in Pounds by Chemical and Year

Chemical Name

No data records returned

Community

Environmental Justice

This section shows indexes from EJScreen, EPA's screening tool for environmental justice (EJ) concerns. EPA uses these indexes to identify geographic areas that may warrant further consideration or analysis for potential EJ concerns. Use of these indexes does not designate an area as an "EJ community" or "EJ facility." EJScreen provides screening level indicators, not a determination of the existence or absence of EJ concerns. For more information, see the EJScreen home page.

Potential Environmental Justice Concerns

- US Territory
- Supplemental/EJ index percentiles >= 90 (Census block group)
- Supplemental/EJ index percentiles >= 90 (1-mile average)

EJScreen Indexes Shown

Index Type

Related Reports

EJScreen Community Report

Download Data

Census Block Group ID: 720291002003	US (Percentile)			State (Percentile)		
	Supplemental Indexes	Facility Census Block Group	1-mile Avg	1-mile Max	Facility Census Block Group	1-mile Avg
Count of Indexes At or Above 90th Percentile	7	3	7	4	0	4
Particulate Matter 2.5	--	N/A	--	--	N/A	--
Ozone	--	N/A	--	--	N/A	--
Diesel Particulate Matter	5	4	9	52	27	56
Air Toxics Cancer Risk	54	33	57	79	0	96
Air Toxics Respiratory Hazard Index	37	31	43	79	29	96
Toxic Releases to Air	99	97	99	96	66	99
Traffic Proximity	99	94	99	96	55	96
Lead Paint	99	53	99	94	22	94
Risk Management Plan (RMP) Facility Proximity	76	58	86	25	15	38
Hazardous Waste Proximity	97	85	99	72	43	92
Superfund Proximity	97	88	99	44	30	44
Underground Storage Tanks (UST)	99	76	99	92	61	94
Wastewater Discharge	99	92	99	70	38	75

Map Display Based on: US State

Display Map Layer

Facility 1-mile Radius Facility Census Block Group

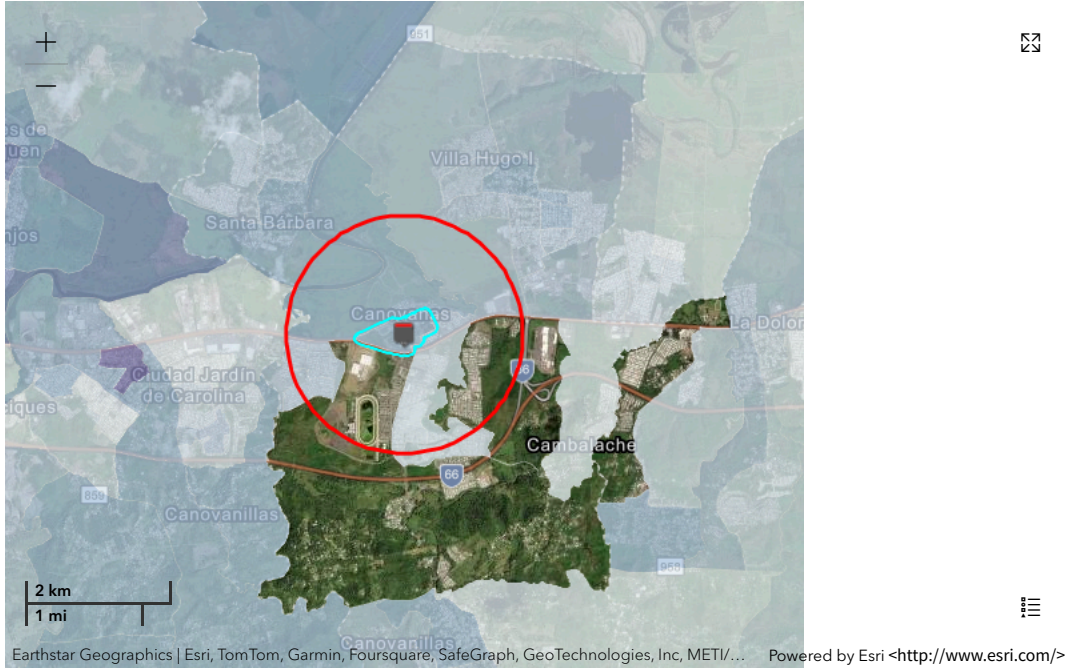

Demographic Profile of Surrounding Area (1-Mile Radius)

This section provides demographic information regarding the community surrounding the facility. ECHO compliance data alone are not sufficient to determine whether violations at a particular facility had negative impacts on public health or the environment. Statistics are based upon the 2010 U.S. Census and 2017 - 2021 American Community Survey (ACS) 5-year Summary and are accurate to the extent that the facility latitude and longitude listed below are correct. Census boundaries and demographic data for U.S. Territories are based on the "2020 Island Areas Demographic Profiles" from the U.S. Census Bureau. EPA's spatial processing methodology considers the overlap between the selected radii and the census blocks (for U.S. Census demographics) and census block groups (for ACS demographics) in determining the demographics surrounding the facility. For more detail about this methodology, see the DFR Data Dictionary <<https://epa.gov/help/reports/dfr-data-dictionary#demographic>>.

General Statistics (U.S. Census)	
Total Persons	8,774
Population Density	2,839/sq.mi.
Housing Units in Area	3,497

General Statistics (ACS (American Community Survey))	
Total Persons	9,549
Percent People of Color	100%
Households in Area	3,196
Households on Public Assistance	121
Persons With Low Income	5,515
Percent With Low Income	58%

Geography	
Radius of Selected Area	1 mi.
Center Latitude	18.377041
Center Longitude	-65.900862
Land Area	98%
Water Area	2%

Income Breakdown (ACS (American Community Survey)) - Households (%)	
Less than \$15,000	654 (20.45%)
\$15,000 - \$25,000	524 (16.39%)

Age Breakdown (U.S. Census) - Persons (%)	
Children 5 years and younger	566 (6%)
Minors 17 years and younger	2,411 (27%)
Adults 18 years and older	6,363 (73%)
Seniors 65 years and older	1,098 (13%)

Race Breakdown (U.S. Census) - Persons (%)	
White	5,717 (65%)
African-American	1,805 (21%)
Hispanic-Origin	8,732 (100%)
Asian/Pacific Islander	17 (0%)
American Indian	57 (1%)
Other/Multiracial	1,179 (13%)

Education Level (Persons 25 & older) (ACS (American Community Survey)) - Persons (%)	
Less than 9th Grade	492 (7.28%)
9th through 12th Grade	340 (5.03%)
High School Diploma	1,590 (23.52%)
Some College/2-year	895 (13.24%)
B.S./B.A. (Bachelor of Science/Bachelor of Arts) or More	2,394 (35.41%)

Income Breakdown (ACS (American Community Survey)) - Households (%)	
\$25,000 - \$50,000	922 (28.83%)
\$50,000 - \$75,000	458 (14.32%)
Greater than \$75,000	640 (20.01%)



Detailed Facility Report

Facility Summary

PILLSBURY PR INC

PR-185 KM 0.2, CANOVANAS, PR 00729

FRS (Facility Registry Service) ID: 110015588032

EPA Region: 02

Latitude: 18.377392

Longitude: -65.901155

Locational Data Source: RCRAINFO

Industries: --

Indian Country: N

Enforcement and Compliance Summary

Statute	RCRA
Compliance Monitoring Activities (5 years)	--
Date of Last Compliance Monitoring Activity	--
Compliance Status	No Violation Identified
Qtrs in Noncompliance (of 12)	0
Qtrs with Significant Violation	0
Informal Enforcement Actions (5 years)	--
Formal Enforcement Actions (5 years)	--
Penalties from Formal Enforcement Actions (5 years)	--
EPA Cases (5 years)	--
Penalties from EPA Cases (5 years)	--

Regulatory Information

Clean Air Act (CAA): No Information

Clean Water Act (CWA): No Information

Resource Conservation and Recovery Act (RCRA): Inactive Other, (PRN008012692)

Safe Drinking Water Act (SDWA): No Information

Other Regulatory Reports

Air Emissions Inventory (EIS): No Information

Greenhouse Gas Emissions (eGGRT): No Information

Toxic Releases (TRI): No Information

Compliance and Emissions Data Reporting Interface (CEDRI): No Information

Go To Enforcement/Compliance Details

Known Data Problems <<https://epa.gov/resources/echo-data/known-data-problems>>

Facility/System Characteristics

Facility/System Characteristics

System	Statute	Identifier	Universe	Status	Areas	Permit Expiration Date	Indian Country	Latitude	Longitude
FRS		110015588032					N	18.377392	-65.901155
RCRAInfo	RCRA	PRN008012692	Other	Inactive ()			N	18.377392	-65.901155

Facility Address

System	Statute	Identifier	Facility Name	Facility Address	Facility County
FRS		110015588032	PILLSBURY PR INC	PR-185 KM 0.2, CANOVANAS, PR 00729	Canóvanas Municipio
RCRAInfo	RCRA	PRN008012692	PILLSBURY PR INC	RD 185 KM 0 HM 2, CANOVANAS, PR 00729-1661	Canóvanas Municipio

Facility SIC (Standard Industrial Classification) Codes

System	Identifier	SIC Code	SIC Description
No data records returned			

Facility NAICS (North American Industry Classification System) Codes

System	Identifier	NAICS Code	NAICS Description
No data records returned			

Facility Tribe Information

Reservation Name	Tribe Name	EPA Tribal ID	Distance to Tribe (miles)
No data records returned			

Enforcement and Compliance

Compliance Monitoring History

Statute	Source ID	System	Activity Type	Compliance Monitoring Type	Lead Agency	Date	Finding (if applicable)
No data records returned							

Entries in italics are not included in ECHO's Compliance Monitoring Activity counts because they are not compliance monitoring strategy <https://www.epa.gov/compliance/compliance-monitoring-programs> activities or because they are not counted as inspections within EPA's Annual Results <https://www.epa.gov/enforcement/enforcement-data-and-results>.

Compliance Summary Data

Statute	Source ID	Current SNC (Significant Noncompliance)/HPV (High Priority Violation)	Current As Of	Qtrs with NC (Noncompliance) (of 12)	Data Last Refreshed
RCRA	PRN008012692	No	07/20/2024	0	07/19/2024

Three-Year Compliance History by Quarter

Statute	Program/Pollutant/Violation Type	QTR 1	QTR 2	QTR 3	QTR 4	QTR 5	QTR 6	QTR 7	QTR 8	QTR 9	QTR 10	QTR 11
RCRA	(Source ID: PRN008012692)	10/01-12/31/21	01/01-03/31/22	04/01-06/30/22	07/01-09/30/22	10/01-12/31/22	01/01-03/31/23	04/01-06/30/23	07/01-09/30/23	10/01-12/31/23	01/01-03/31/24	04/01-06/30/24
	Facility-Level Status	No Violation Identified	No Violation Identified	No Violation Identified	No Violation Identified	No Violation Identified	No Violation Identified	No Violation Identified	No Violation Identified	No Violation Identified	No Violation Identified	No Violation Identified
	Violation Agency											

Informal Enforcement Actions

Statute	System	Source ID	Type of Action	Lead Agency	Date
No data records returned					

Entries in italics are not counted as "informal enforcement actions" in EPA policies pertaining to enforcement response tools.

Formal Enforcement Actions

Statute	System	Law/Section	Source ID	Type of Action	Case No.	Lead Agency	Case Name	Issued/ Filed Date	Settlements/ Actions	Settlement/ Action Date	Federal Penalty Assessed	State/ Local Penalty Assessed	Penalty Amount Collected	SEP Value	Comp Action Cost
No data records returned															

Environmental Conditions

Watersheds

12-Digit WBD (Watershed Boundary Dataset) HUC (RAD (Reach Address Database))	WBD (Watershed Boundary Dataset) Subwatershed Name (RAD (Reach Address Database))	State Water Body Name (ICIS (Integrated Compliance Information System))	Beach Closures Within Last Year	Beach Closures Within Last Two Years	Pollutants Potentially Related to Impairment	Watershed with ESA (Endangered Species Act)-listed Aquatic Species?
No data records returned						

Assessed Waters From Latest State Submission (ATTAINS)

State	Report Cycle	Assessment Unit ID	Assessment Unit Name	Water Condition	Cause Groups Impaired	Drinking Water Use	Ecological Use	Fish Consumption Use	Recreation Use	Other Use
-------	--------------	--------------------	----------------------	-----------------	-----------------------	--------------------	----------------	----------------------	----------------	-----------

No data records returned

Air Quality Nonattainment Areas

Pollutant	Within Nonattainment Status Area?	Nonattainment Status Applicable Standard(s)	Within Maintenance Status Area?	Maintenance Status Applicable Standard(s)
-----------	-----------------------------------	---	---------------------------------	---

No data records returned

Pollutants

Toxics Release Inventory History of Reported Chemicals Released or Transferred in Pounds per Year at Site

TRI Facility ID	Year	Air Emissions	Surface Water Discharges	Off-Site Transfers to POTWs (Publicly Owned Treatment Works)	Underground Injections	Disposal to Land	Total On-Site Releases	Total Off-Site Transfers
-----------------	------	---------------	--------------------------	--	------------------------	------------------	------------------------	--------------------------

No data records returned

Toxics Release Inventory Total Releases and Transfers in Pounds by Chemical and Year

Chemical Name

No data records returned

Community

Environmental Justice

This section shows indexes from EJScreen, EPA's screening tool for environmental justice (EJ) concerns. EPA uses these indexes to identify geographic areas that may warrant further consideration or analysis for potential EJ concerns. Use of these indexes does not designate an area as an "EJ community" or "EJ facility." EJScreen provides screening level indicators, not a determination of the existence or absence of EJ concerns. For more information, see the EJScreen home page.

Potential Environmental Justice Concerns

- US Territory
- Supplemental/EJ index percentiles >= 90 (Census block group)
- Supplemental/EJ index percentiles >= 90 (1-mile average)

EJScreen Indexes Shown

Index Type

Related Reports

EJScreen Community Report

Download Data

Census Block Group ID: 720291002003	US (Percentile)			State (Percentile)		
	Supplemental Indexes	Facility Census Block Group	1-mile Avg	1-mile Max	Facility Census Block Group	1-mile Avg
Count of Indexes At or Above 90th Percentile	7	3	7	4	0	4
Particulate Matter 2.5	--	N/A	--	--	N/A	--
Ozone	--	N/A	--	--	N/A	--
Diesel Particulate Matter	5	4	9	52	27	56
Air Toxics Cancer Risk	54	33	57	79	0	96
Air Toxics Respiratory Hazard Index	37	31	43	79	30	96
Toxic Releases to Air	99	97	99	96	66	99
Traffic Proximity	99	94	99	96	55	96
Lead Paint	99	53	99	94	22	94
Risk Management Plan (RMP) Facility Proximity	76	58	86	25	15	38
Hazardous Waste Proximity	97	85	99	72	43	92
Superfund Proximity	97	88	99	44	30	44
Underground Storage Tanks (UST)	99	76	99	92	61	94
Wastewater Discharge	99	92	99	70	38	75

Map Display Based on: US State

Display Map Layer

Facility 1-mile Radius Facility Census Block Group

+
—

☒

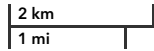

Powered by Esri <<http://www.esri.com/>>

Demographic Profile of Surrounding Area (1-Mile Radius)

This section provides demographic information regarding the community surrounding the facility. ECHO compliance data alone are not sufficient to determine whether violations at a particular facility had negative impacts on public health or the environment. Statistics are based upon the 2010 U.S. Census and 2017 - 2021 American Community Survey (ACS) 5-year Summary and are accurate to the extent that the facility latitude and longitude listed below are correct. Census boundaries and demographic data for U.S. Territories are based on the "2020 Island Areas Demographic Profiles" from the U.S. Census Bureau. EPA's spatial processing methodology considers the overlap between the selected radii and the census blocks (for U.S. Census demographics) and census block groups (for ACS demographics) in determining the demographics surrounding the facility. For more detail about this methodology, see the DFR Data Dictionary <<https://epa.gov/help/reports/dfr-data-dictionary#demographic>>.

General Statistics (U.S. Census)	
Total Persons	8,665
Population Density	2,819/sq.mi.
Housing Units in Area	3,465

General Statistics (ACS (American Community Survey))	
Total Persons	9,524
Percent People of Color	100%
Households in Area	3,198
Households on Public Assistance	122
Persons With Low Income	5,569
Percent With Low Income	59%

Geography	
Radius of Selected Area	1 mi.
Center Latitude	18.377392
Center Longitude	-65.901155
Land Area	98%
Water Area	2%

Income Breakdown (ACS (American Community Survey)) - Households (%)	
Less than \$15,000	666 (20.82%)
\$15,000 - \$25,000	531 (16.6%)

Age Breakdown (U.S. Census) - Persons (%)	
Children 5 years and younger	554 (6%)
Minors 17 years and younger	2,368 (27%)
Adults 18 years and older	6,297 (73%)
Seniors 65 years and older	1,107 (13%)

Race Breakdown (U.S. Census) - Persons (%)	
White	5,614 (65%)
African-American	1,802 (21%)
Hispanic-Origin	8,621 (99%)
Asian/Pacific Islander	16 (0%)
American Indian	57 (1%)
Other/Multiracial	1,176 (14%)

Education Level (Persons 25 & older) (ACS (American Community Survey)) - Persons (%)	
Less than 9th Grade	508 (7.51%)
9th through 12th Grade	344 (5.08%)
High School Diploma	1,612 (23.83%)
Some College/2-year	893 (13.2%)
B.S./B.A. (Bachelor of Science/Bachelor of Arts) or More	2,362 (34.92%)

Income Breakdown (ACS (American Community Survey)) - Households (%)	
\$25,000 - \$50,000	928 (29.01%)
\$50,000 - \$75,000	452 (14.13%)
Greater than \$75,000	622 (19.44%)



Detailed Facility Report

Facility Summary

EXPRESS AUTO GULF STATION

106 PALMER ST, CANOVANAS, PR 00729

FRS (Facility Registry Service) ID: 110004891127

EPA Region: 02

Latitude: 18.380333

Longitude: -65.89894

Locational Data Source: FRS

Industries: --

Indian Country: N

Enforcement and Compliance Summary

Statute	RCRA
Compliance Monitoring Activities (5 years)	--
Date of Last Compliance Monitoring Activity	05/22/1997
Compliance Status	No Violation Identified
Qtrs in Noncompliance (of 12)	0
Qtrs with Significant Violation	0
Informal Enforcement Actions (5 years)	--
Formal Enforcement Actions (5 years)	--
Penalties from Formal Enforcement Actions (5 years)	--
EPA Cases (5 years)	--
Penalties from EPA Cases (5 years)	--

Regulatory Information

Clean Air Act (CAA): No Information

Clean Water Act (CWA): No Information

Resource Conservation and Recovery Act (RCRA): Inactive Other, (PRO007002280)

Safe Drinking Water Act (SDWA): No Information

Other Regulatory Reports

Air Emissions Inventory (EIS): No Information

Greenhouse Gas Emissions (eGGRT): No Information

Toxic Releases (TRI): No Information

Compliance and Emissions Data Reporting Interface (CEDRI): No Information

Go To Enforcement/Compliance Details

Known Data Problems <<https://epa.gov/resources/echo-data/known-data-problems>>

Facility/System Characteristics

Facility/System Characteristics

System	Statute	Identifier	Universe	Status	Areas	Permit Expiration Date	Indian Country	Latitude	Longitude
FRS		110004891127					N	18.380333	-65.89894
RCRAInfo	RCRA	PRO007002280	Other	Inactive ()			N	18.379999	-65.899865

Facility Address

System	Statute	Identifier	Facility Name	Facility Address	Facility County
FRS		110004891127	EXPRESS AUTO GULF STATION	106 PALMER ST, CANOVANAS, PR 00729	Canóvanas Municipio
RCRAInfo	RCRA	PRO007002280	EXPRESS AUTO GULF STATION	106 PALMER ST, CANOVANAS, PR 00729	Canóvanas Municipio

Facility SIC (Standard Industrial Classification) Codes

System	Identifier	SIC Code	SIC Description
No data records returned			

Facility NAICS (North American Industry Classification System) Codes

System	Identifier	NAICS Code	NAICS Description
No data records returned			

Facility Tribe Information

Reservation Name	Tribe Name	EPA Tribal ID	Distance to Tribe (miles)
No data records returned			

Enforcement and Compliance

Compliance Monitoring History

Statute	Source ID	System	Activity Type	Compliance Monitoring Type	Lead Agency	Date	Finding (if applicable)
No data records returned							

Entries in italics are not included in ECHO's Compliance Monitoring Activity counts because they are not compliance monitoring strategy <https://www.epa.gov/compliance/compliance-monitoring-programs> activities or because they are not counted as inspections within EPA's Annual Results <https://www.epa.gov/enforcement/enforcement-data-and-results>.

Compliance Summary Data

Statute	Source ID	Current SNC (Significant Noncompliance)/HPV (High Priority Violation)	Current As Of	Qtrs with NC (Noncompliance) (of 12)	Data Last Refreshed
RCRA	PRO007002280	No	07/20/2024	0	07/19/2024

Three-Year Compliance History by Quarter

Statute	Program/Pollutant/Violation Type	QTR 1	QTR 2	QTR 3	QTR 4	QTR 5	QTR 6	QTR 7	QTR 8	QTR 9	QTR 10	QTR 11
RCRA	(Source ID: PRO007002280)	10/01-12/31/21	01/01-03/31/22	04/01-06/30/22	07/01-09/30/22	10/01-12/31/22	01/01-03/31/23	04/01-06/30/23	07/01-09/30/23	10/01-12/31/23	01/01-03/31/24	04/01-06/30/24
	Facility-Level Status	No Violation Identified	No Violation Identified	No Violation Identified	No Violation Identified	No Violation Identified	No Violation Identified	No Violation Identified	No Violation Identified	No Violation Identified	No Violation Identified	No Violation Identified
	Violation Agency											

Informal Enforcement Actions

Statute	System	Source ID	Type of Action	Lead Agency	Date
No data records returned					

Entries in italics are not counted as "informal enforcement actions" in EPA policies pertaining to enforcement response tools.

Formal Enforcement Actions

Statute	System	Law/Section	Source ID	Type of Action	Case No.	Lead Agency	Case Name	Issued/ Filed Date	Settlements/ Actions	Settlement/ Action Date	Federal Penalty Assessed	State/ Local Penalty Assessed	Penalty Amount Collected	SEP Value	Comp Action Cost
No data records returned															

Environmental Conditions

Watersheds

12-Digit WBD (Watershed Boundary Dataset) HUC (RAD (Reach Address Database))	WBD (Watershed Boundary Dataset) Subwatershed Name (RAD (Reach Address Database))	State Water Body Name (ICIS (Integrated Compliance Information System))	Beach Closures Within Last Year	Beach Closures Within Last Two Years	Pollutants Potentially Related to Impairment	Watershed with ESA (Endangered Species Act)-listed Aquatic Species?
No data records returned						

Assessed Waters From Latest State Submission (ATTAINS)

State	Report Cycle	Assessment Unit ID	Assessment Unit Name	Water Condition	Cause Groups Impaired	Drinking Water Use	Ecological Use	Fish Consumption Use	Recreation Use	Other Use
-------	--------------	--------------------	----------------------	-----------------	-----------------------	--------------------	----------------	----------------------	----------------	-----------

No data records returned

Air Quality Nonattainment Areas

Pollutant	Within Nonattainment Status Area?	Nonattainment Status Applicable Standard(s)	Within Maintenance Status Area?	Maintenance Status Applicable Standard(s)
-----------	-----------------------------------	---	---------------------------------	---

No data records returned

Pollutants

Toxics Release Inventory History of Reported Chemicals Released or Transferred in Pounds per Year at Site

TRI Facility ID	Year	Air Emissions	Surface Water Discharges	Off-Site Transfers to POTWs (Publicly Owned Treatment Works)	Underground Injections	Disposal to Land	Total On-Site Releases	Total Off-Site Transfers
-----------------	------	---------------	--------------------------	--	------------------------	------------------	------------------------	--------------------------

No data records returned

Toxics Release Inventory Total Releases and Transfers in Pounds by Chemical and Year

Chemical Name

No data records returned

Community

Environmental Justice

This section shows indexes from EJScreen, EPA's screening tool for environmental justice (EJ) concerns. EPA uses these indexes to identify geographic areas that may warrant further consideration or analysis for potential EJ concerns. Use of these indexes does not designate an area as an "EJ community" or "EJ facility." EJScreen provides screening level indicators, not a determination of the existence or absence of EJ concerns. For more information, see the EJScreen home page.

Potential Environmental Justice Concerns

- US Territory
- Supplemental/EJ index percentiles >= 90 (Census block group)
- Supplemental/EJ index percentiles >= 90 (1-mile average)

EJScreen Indexes Shown

Index Type

Related Reports

EJScreen Community Report

Download Data

Census Block Group ID: 720291002001	US (Percentile)			State (Percentile)		
	Supplemental Indexes	Facility Census Block Group	1-mile Avg	1-mile Max	Facility Census Block Group	1-mile Avg
Count of indexes At or Above 90th Percentile	7	3	7	0	0	4
Particulate Matter 2.5	--	N/A	--	--	N/A	--
Ozone	--	N/A	--	--	N/A	--
Diesel Particulate Matter	4	3	9	40	24	56
Air Toxics Cancer Risk	52	33	57	49	0	96
Air Toxics Respiratory Hazard Index	34	31	43	50	32	96
Toxic Releases to Air	99	97	99	83	68	99
Traffic Proximity	99	95	99	78	58	96
Lead Paint	97	58	99	77	24	94
Risk Management Plan (RMP) Facility Proximity	68	58	86	20	15	38
Hazardous Waste Proximity	93	84	99	59	41	92
Superfund Proximity	94	89	99	36	30	44
Underground Storage Tanks (UST)	92	83	99	72	62	94
Wastewater Discharge	98	93	99	59	40	75

Map Display Based on: US State

Display Map Layer

Facility 1-mile Radius Facility Census Block Group

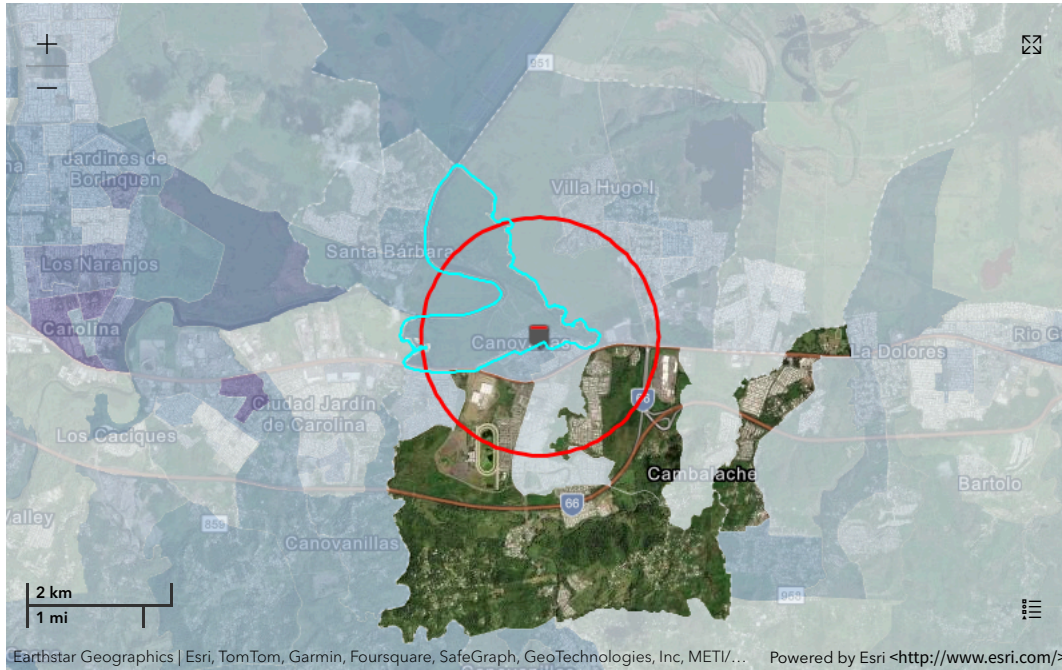

Demographic Profile of Surrounding Area (1-Mile Radius)

This section provides demographic information regarding the community surrounding the facility. ECHO compliance data alone are not sufficient to determine whether violations at a particular facility had negative impacts on public health or the environment. Statistics are based upon the 2010 U.S. Census and 2017 - 2021 American Community Survey (ACS) 5-year Summary and are accurate to the extent that the facility latitude and longitude listed below are correct. Census boundaries and demographic data for U.S. Territories are based on the "2020 Island Areas Demographic Profiles" from the U.S. Census Bureau. EPA's spatial processing methodology considers the overlap between the selected radii and the census blocks (for U.S. Census demographics) and census block groups (for ACS demographics) in determining the demographics surrounding the facility. For more detail about this methodology, see the DFR Data Dictionary <<https://epa.gov/help/reports/dfr-data-dictionary#demographic>>.

General Statistics (U.S. Census)	
Total Persons	7,433
Population Density	2,422/sq.mi.
Housing Units in Area	3,043

General Statistics (ACS (American Community Survey))	
Total Persons	8,011
Percent People of Color	100%
Households in Area	2,824
Households on Public Assistance	111
Persons With Low Income	4,939
Percent With Low Income	62%

Geography	
Radius of Selected Area	1 mi.
Center Latitude	18.380333
Center Longitude	-65.89894
Land Area	99%
Water Area	1%

Income Breakdown (ACS (American Community Survey)) - Households (%)	
Less than \$15,000	727 (25.76%)
\$15,000 - \$25,000	541 (19.17%)

Age Breakdown (U.S. Census) - Persons (%)	
Children 5 years and younger	492 (7%)
Minors 17 years and younger	2,062 (28%)
Adults 18 years and older	5,372 (72%)
Seniors 65 years and older	852 (11%)

Race Breakdown (U.S. Census) - Persons (%)	
White	4,567 (61%)
African-American	1,694 (23%)
Hispanic-Origin	7,369 (99%)
Asian/Pacific Islander	17 (0%)
American Indian	50 (1%)
Other/Multiracial	1,106 (15%)

Education Level (Persons 25 & older) (ACS (American Community Survey)) - Persons (%)	
Less than 9th Grade	731 (12.82%)
9th through 12th Grade	302 (5.3%)
High School Diploma	1,331 (23.35%)
Some College/2-year	708 (12.42%)
B.S./B.A. (Bachelor of Science/Bachelor of Arts) or More	1,769 (31.03%)

Income Breakdown (ACS (American Community Survey)) - Households (%)	
\$25,000 - \$50,000	726 (25.73%)
\$50,000 - \$75,000	329 (11.66%)
Greater than \$75,000	499 (17.68%)



Detailed Facility Report

Facility Summary

A & P PROOFING INSULATION INC

PO BOX 146, CANOVANAS, PR 00729

FRS (Facility Registry Service) ID: 110008053355

EPA Region: 02

Latitude: 18.379343

Longitude: -65.899218

Locational Data Source: TRIS

Industries: Chemical Manufacturing

Indian Country: N

Enforcement and Compliance Summary

No data records returned

Regulatory Information

Clean Air Act (CAA): No Information

Clean Water Act (CWA): No Information

Resource Conservation and Recovery Act (RCRA):
No Information

Safe Drinking Water Act (SDWA): No Information

Other Regulatory Reports

Air Emissions Inventory (EIS): No Information

Greenhouse Gas Emissions (eGGRT): No Information

Toxic Releases (TRI): 00629PRFNGPOBOX

**Compliance and Emissions Data Reporting
Interface (CEDRI):**
No Information

Go To Enforcement/Compliance Details

Known Data Problems <<https://epa.gov/resources/echo-data/known-data-problems>>

Facility/System Characteristics

Facility/System Characteristics

System	Statute	Identifier	Universe	Status	Areas	Permit Expiration Date	Indian Country	Latitude	Longitude
FRS		110008053355					N	18.379343	-65.899218
TRI	EP313	00629PRFNGPOBOX	Toxics Release Inventory	Last Reported for 1988			N	18.379343	-65.899218

Facility Address

System	Statute	Identifier	Facility Name	Facility Address	Facility County
FRS		110008053355	A & P PROOFING INSULATION INC	PO BOX 146, CANOVANAS, PR 00729	Canóvanas Municipio
TRI	EP313	00629PRFNGPOBOX	A & P PROOFING INSULATION INC	PO BOX 146, CANOVANAS, PR 00729	Canóvanas Municipio

Facility SIC (Standard Industrial Classification) Codes

System	Identifier	SIC Code	SIC Description
--------	------------	----------	-----------------

No data records returned

Facility NAICS (North American Industry Classification System) Codes

System	Identifier	NAICS Code	NAICS Description
TRI	00629PRFNGPOBOX	325520	Adhesive Manufacturing

Facility Tribe Information

Reservation Name	Tribe Name	EPA Tribal ID	Distance to Tribe (miles)
------------------	------------	---------------	---------------------------

No data records returned

Enforcement and Compliance

Compliance Monitoring History

Last 5 Years

Statute	Source ID	System	Activity Type	Compliance Monitoring Type	Lead Agency	Date	Finding (if applicable)
---------	-----------	--------	---------------	----------------------------	-------------	------	-------------------------

No data records returned

Entries in italics are not included in ECHO's Compliance Monitoring Activity counts because they are not compliance monitoring strategy <<https://www.epa.gov/compliance/compliance-monitoring-programs>> activities or because they are not counted as inspections within EPA's Annual Results <<https://www.epa.gov/enforcement/enforcement-data-and-results>>.

Compliance Summary Data

Statute	Source ID	Current SNC (Significant Noncompliance)/HPV (High Priority Violation)	Current As Of	Qtrs with NC (Noncompliance) (of 12)	Data Last Refreshed
---------	-----------	---	---------------	--------------------------------------	---------------------

No data records returned

Three-Year Compliance History by Quarter

Informal Enforcement Actions Last 5 Years

Statute	System	Source ID	Type of Action	Lead Agency	Date
---------	--------	-----------	----------------	-------------	------

No data records returned

Entries in italics are not counted as "informal enforcement actions" in EPA policies pertaining to enforcement response tools.

Formal Enforcement Actions Last 5 Years

Statute	System	Law/Section	Source ID	Type of Action	Case No.	Lead Agency	Case Name	Issued/Filed Date	Settlements/Actions	Settlement/Action Date	Federal Penalty Assessed	State/Local Penalty Assessed	Penalty Amount Collected	SEP Value	Comp Action Cost
---------	--------	-------------	-----------	----------------	----------	-------------	-----------	-------------------	---------------------	------------------------	--------------------------	------------------------------	--------------------------	-----------	------------------

No data records returned

Environmental Conditions

Watersheds

12-Digit WBD (Watershed Boundary Dataset) HUC (RAD (Reach Address Database))	WBD (Watershed Boundary Dataset) Subwatershed Name (RAD (Reach Address Database))	State Water Body Name (ICIS (Integrated Compliance Information System))	Beach Closures Within Last Year	Beach Closures Within Last Two Years	Pollutants Potentially Related to Impairment	Watershed with ESA (Endangered Species Act)-listed Aquatic Species?
--	---	---	---------------------------------	--------------------------------------	--	---

No data records returned

Assessed Waters From Latest State Submission (ATTAINS)

State	Report Cycle	Assessment Unit ID	Assessment Unit Name	Water Condition	Cause Groups Impaired	Drinking Water Use	Ecological Use	Fish Consumption Use	Recreation Use	Other Use
-------	--------------	--------------------	----------------------	-----------------	-----------------------	--------------------	----------------	----------------------	----------------	-----------

No data records returned

Air Quality Nonattainment Areas

Pollutant	Within Nonattainment Status Area?	Nonattainment Status Applicable Standard(s)	Within Maintenance Status Area?	Maintenance Status Applicable Standard(s)
-----------	-----------------------------------	---	---------------------------------	---

No data records returned

Pollutants

Toxics Release Inventory History of Reported Chemicals

Released or Transferred in Pounds per Year at Site

TRI Facility ID	Year	Air Emissions	Surface Water Discharges	Off-Site Transfers to POTWs (Publicly Owned Treatment Works)	Underground Injections	Disposal to Land	Total On-Site Releases	Total Off-Site Transfers
-----------------	------	---------------	--------------------------	--	------------------------	------------------	------------------------	--------------------------

No data records returned

Toxics Release Inventory Total Releases and Transfers in Pounds by Chemical and Year

Chemical Name

No data records returned

Community

Environmental Justice

This section shows indexes from EJScreen, EPA's screening tool for environmental justice (EJ) concerns. EPA uses these indexes to identify geographic areas that may warrant further consideration or analysis for potential EJ concerns. Use of these indexes does not designate an area as an "EJ community" or "EJ facility." EJScreen provides screening level indicators, not a determination of the existence or absence of EJ concerns. For more information, see the EJScreen home page.

Potential Environmental Justice Concerns

- US Territory
- Supplemental/EJ index percentiles ≥ 90 (Census block group)
- Supplemental/EJ index percentiles ≥ 90 (1-mile average)

EJScreen Indexes Shown

Index Type Supplemental (default)

Related Reports

EJScreen Community Report

Download Data

Census Block Group ID: 720291002003	US (Percentile)			State (Percentile)		
	Supplemental Indexes	Facility Census Block Group	1-mile Avg	1-mile Max	Facility Census Block Group	1-mile Avg
Count of Indexes At or Above 90th Percentile	7	3	7	4	0	4
Particulate Matter 2.5	--	N/A	--	--	N/A	--
Ozone	--	N/A	--	--	N/A	--
Diesel Particulate Matter	5	3	9	52	24	56

Census Block Group ID: 720291002003	US (Percentile)			State (Percentile)		
Supplemental Indexes	Facility Census Block Group	1-mile Avg	1-mile Max	Facility Census Block Group	1-mile Avg	1-mile Max
Air Toxics Cancer Risk	54	33	57	79	0	96
Air Toxics Respiratory Hazard Index	37	31	43	79	30	96
Toxic Releases to Air	99	97	99	96	66	99
Traffic Proximity	99	94	99	96	56	96
Lead Paint	99	56	99	94	23	94
Risk Management Plan (RMP) Facility Proximity	76	57	86	25	15	38
Hazardous Waste Proximity	97	84	99	72	41	92
Superfund Proximity	97	89	99	44	29	44
Underground Storage Tanks (UST)	99	82	99	92	62	94
Wastewater Discharge	99	93	99	70	39	75

Map Display Based on: US State

Display Map Layer

Facility 1-mile Radius Facility Census Block Group



Earthstar Geographics | Esri, TomTom, Garmin, Foursquare, SafeGraph, ... Powered by Esri <<http://www.esri.com/>>

Demographic Profile of Surrounding Area (1-Mile Radius)

This section provides demographic information regarding the community surrounding the facility. ECHO compliance data alone are not sufficient to determine whether violations at a particular facility had negative impacts on public health or the environment. Statistics are based upon the 2010 U.S. Census and 2017 - 2021 American Community Survey (ACS) 5-year Summary and are accurate to the extent that the facility latitude and longitude listed below are correct. Census boundaries and demographic data for U.S. Territories are based on the "2020 Island Areas Demographic Profiles" from the U.S. Census Bureau. EPA's spatial processing methodology considers the overlap between the selected radii and the census blocks (for U.S. Census demographics) and census block groups (for ACS demographics) in determining the demographics surrounding the facility. For more detail about this methodology, see the DFR Data Dictionary <<https://epa.gov/help/reports/dfr-data-dictionary#demographic>>.

General Statistics (U.S. Census)

Total Persons	7,480
Population Density	2,440/sq.mi.
Housing Units in Area	3,039

General Statistics (ACS (American Community Survey))

Total Persons	8,308
Percent People of Color	100%
Households in Area	2,878
Households on Public Assistance	113
Persons With Low Income	4,969
Percent With Low Income	60%

Geography

Radius of Selected Area	1 mi.
Center Latitude	18.379343
Center Longitude	-65.899218
Land Area	99%
Water Area	1%

Income Breakdown (ACS (American Community Survey)) - Households (%)

Less than \$15,000	683 (23.76%)
\$15,000 - \$25,000	520 (18.09%)
\$25,000 - \$50,000	766 (26.64%)
\$50,000 - \$75,000	360 (12.52%)
Greater than \$75,000	546 (18.99%)

Age Breakdown (U.S. Census) - Persons (%)

Children 5 years and younger	483 (6%)
Minors 17 years and younger	2,073 (28%)
Adults 18 years and older	5,407 (72%)
Seniors 65 years and older	887 (12%)

Race Breakdown (U.S. Census) - Persons (%)

White	4,724 (63%)
African-American	1,632 (22%)
Hispanic-Origin	7,424 (99%)
Asian/Pacific Islander	15 (0%)
American Indian	48 (1%)
Other/Multiracial	1,061 (14%)

Education Level (Persons 25 & older) (ACS (American Community Survey)) - Persons (%)

Less than 9th Grade	630 (10.72%)
9th through 12th Grade	306 (5.2%)
High School Diploma	1,363 (23.18%)
Some College/2-year	746 (12.69%)
B.S./B.A. (Bachelor of Science/Bachelor of Arts) or More	1,940 (33%)



Detailed Facility Report

Facility Summary

CANOVANAS INDIAN CLEANER

100 CALLE CORCHADO, CANOVANAS, PR 00729

FRS (Facility Registry Service) ID: 110005973642

EPA Region: 02

Latitude: 18.37822

Longitude: -65.89894

Locational Data Source: FRS

Industries: Personal and Laundry Services

Indian Country: N

Enforcement and Compliance Summary

Statute	CAA
Compliance Monitoring Activities (5 years)	--
Date of Last Compliance Monitoring Activity	09/12/2013
Compliance Status	No Violation Identified
Qtrs in Noncompliance (of 12)	0
Qtrs with Significant Violation	0
Informal Enforcement Actions (5 years)	--
Formal Enforcement Actions (5 years)	--
Penalties from Formal Enforcement Actions (5 years)	--
EPA Cases (5 years)	--
Penalties from EPA Cases (5 years)	--
Statute	RCRA
Compliance Monitoring Activities (5 years)	--
Date of Last Compliance Monitoring Activity	--
Compliance Status	No Violation Identified
Qtrs in Noncompliance (of 12)	0
Qtrs with Significant Violation	0
Informal Enforcement Actions (5 years)	--
Formal Enforcement Actions (5 years)	--
Penalties from Formal Enforcement Actions (5 years)	--
EPA Cases (5 years)	--
Penalties from EPA Cases (5 years)	--

Regulatory Information

Clean Air Act (CAA): Operating Minor (PR0000007202900015)

Clean Water Act (CWA): No Information

Other Regulatory Reports

Air Emissions Inventory (EIS): No Information

Greenhouse Gas Emissions (eGGRT): No Information

Resource Conservation and Recovery Act (RCRA): Inactive Other, (PRN000021865)

Toxic Releases (TRI): No Information

Compliance and Emissions Data Reporting Interface (CEDRI): No Information

Safe Drinking Water Act (SDWA): No Information

Go To Enforcement/Compliance Details

Known Data Problems <https://epa.gov/resources/echo-data/known-data-problems>

Facility/System Characteristics

Facility/System Characteristics

Table with 10 columns: System, Statute, Identifier, Universe, Status, Areas, Permit Expiration Date, Indian Country, Latitude, Longitude. Rows include FRS, ICIS-Air, and RCRAInfo.

Facility Address

Table with 6 columns: System, Statute, Identifier, Facility Name, Facility Address, Facility County. Rows include FRS, ICIS-Air, and RCRAInfo.

Facility SIC (Standard Industrial Classification) Codes

Table with 4 columns: System, Identifier, SIC Code, SIC Description. Row for ICIS-Air with SIC Code 7216.

Facility NAICS (North American Industry Classification System) Codes

Table with 4 columns: System, Identifier, NAICS Code, NAICS Description. Row for ICIS-Air with NAICS Code 812320.

Facility Tribe Information

Table with 4 columns: Reservation Name, Tribe Name, EPA Tribal ID, Distance to Tribe (miles).

No data records returned

Enforcement and Compliance

Compliance Monitoring History Last 5 Years

Table with 8 columns: Statute, Source ID, System, Activity Type, Compliance Monitoring Type, Lead Agency, Date, Finding (if applicable).

No data records returned

Entries in italics are not included in ECHO's Compliance Monitoring Activity counts because they are not compliance monitoring strategy <https://www.epa.gov/compliance/compliance-monitoring-programs> activities or because they are not counted as inspections within EPA's Annual Results <https://www.epa.gov/enforcement/enforcement-data-and-results>.

Compliance Summary Data

Table with 6 columns: Statute, Source ID, Current SNC (Significant Noncompliance)/HPV (High Priority Violation), Current As Of, Qtrs with NC (Noncompliance) (of 12), Data Last Refreshed.

Three-Year Compliance History by Quarter

Table with 13 columns: Statute, Program/Pollutant/Violation Type, QTR 1-10, Facility-Level Status, HPV History, Violation Type, Agency, Programs, Pollutants.

Table with 13 columns: Statute, Program/Pollutant/Violation Type, QTR 1-11, Facility-Level Status, Violation, Agency.

Informal Enforcement Actions Last 5 Years

Statute	System	Source ID	Type of Action	Lead Agency	Date
---------	--------	-----------	----------------	-------------	------

No data records returned

Entries in italics are not counted as "informal enforcement actions" in EPA policies pertaining to enforcement response tools.

Formal Enforcement Actions Last 5 Years

Statute	System	Law/Section	Source ID	Type of Action	Case No.	Lead Agency	Case Name	Issued/ Filed Date	Settlements/ Actions	Settlement/ Action Date	Federal Penalty Assessed	State/ Local Penalty Assessed	Penalty Amount Collected	SEP Value	Comp Action Cost
---------	--------	-------------	-----------	----------------	----------	-------------	-----------	--------------------	----------------------	-------------------------	--------------------------	-------------------------------	--------------------------	-----------	------------------

No data records returned

Environmental Conditions

Watersheds

12-Digit WBD (Watershed Boundary Dataset) HUC (RAD (Reach Address Database))	WBD (Watershed Boundary Dataset) Subwatershed Name (RAD (Reach Address Database))	State Water Body Name (ICIS (Integrated Compliance Information System))	Beach Closures Within Last Year	Beach Closures Within Last Two Years	Pollutants Potentially Related to Impairment	Watershed with ESA (Endangered Species Act)-listed Aquatic Species?
--	---	---	---------------------------------	--------------------------------------	--	---

No data records returned

Assessed Waters From Latest State Submission (ATTAINS)

State	Report Cycle	Assessment Unit ID	Assessment Unit Name	Water Condition	Cause Groups Impaired	Drinking Water Use	Ecological Use	Fish Consumption Use	Recreation Use	Other Use
-------	--------------	--------------------	----------------------	-----------------	-----------------------	--------------------	----------------	----------------------	----------------	-----------

No data records returned

Air Quality Nonattainment Areas

Pollutant	Within Nonattainment Status Area?	Nonattainment Status Applicable Standard(s)	Within Maintenance Status Area?	Maintenance Status Applicable Standard(s)
-----------	-----------------------------------	---	---------------------------------	---

No data records returned

Pollutants

Toxics Release Inventory History of Reported Chemicals Released or Transferred in Pounds per Year at Site

TRI Facility ID	Year	Air Emissions	Surface Water Discharges	Off-Site Transfers to POTWs (Publicly Owned Treatment Works)	Underground Injections	Disposal to Land	Total On-Site Releases	Total Off-Site Transfers
-----------------	------	---------------	--------------------------	--	------------------------	------------------	------------------------	--------------------------

No data records returned

Toxics Release Inventory Total Releases and Transfers in Pounds by Chemical and Year

Chemical Name

No data records returned

Community

Environmental Justice

This section shows indexes from EJScreen, EPA's screening tool for environmental justice (EJ) concerns. EPA uses these indexes to identify geographic areas that may warrant further consideration or analysis for potential EJ concerns. Use of these indexes does not designate an area as an "EJ community" or "EJ facility." EJScreen provides screening level indicators, not a determination of the existence or absence of EJ concerns. For more information, see the EJScreen home page.

Potential Environmental Justice Concerns

- US Territory
- Supplemental/EJ index percentiles >= 90 (Census block group)
- Supplemental/EJ index percentiles >= 90 (1-mile average)

EJScreen Indexes Shown

Index Type

Related Reports

EJScreen Community Report

Download Data

Census Block Group ID: 720291002003	US (Percentile)			State (Percentile)		
	Supplemental Indexes	Facility Census Block Group	1-mile Avg	1-mile Max	Facility Census Block Group	1-mile Avg
Count of Indexes At or Above 90th Percentile	7	3	7	4	0	4
Particulate Matter 2.5	--	N/A	--	--	N/A	--
Ozone	--	N/A	--	--	N/A	--
Diesel Particulate Matter	5	3	9	52	25	56
Air Toxics Cancer Risk	54	33	57	79	0	96
Air Toxics Respiratory Hazard Index	37	31	43	79	30	96
Toxic Releases to Air	99	97	99	96	66	99
Traffic Proximity	99	94	99	96	56	96
Lead Paint	99	57	99	94	24	94
Risk Management Plan (RMP) Facility Proximity	76	57	86	25	15	38
Hazardous Waste Proximity	97	84	99	72	42	92
Superfund Proximity	97	88	99	44	29	44
Underground Storage Tanks (UST)	99	82	99	92	62	94
Wastewater Discharge	99	93	99	70	39	75

Map Display Based on: US State

Display Map Layer

Facility 1-mile Radius Facility Census Block Group

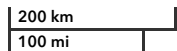

Earthstar Geographics



Powered by Esri <http://www.esri.com/>

Demographic Profile of Surrounding Area (1-Mile Radius)

This section provides demographic information regarding the community surrounding the facility. ECHO compliance data alone are not sufficient to determine whether violations at a particular facility had negative impacts on public health or the environment. Statistics are based upon the 2010 U.S. Census and 2017 - 2021 American Community Survey (ACS) 5-year Summary and are accurate to the extent that the facility latitude and longitude listed below are correct. Census boundaries and demographic data for U.S. Territories are based on the "2020 Island Areas Demographic Profiles" from the U.S. Census Bureau. EPA's spatial processing methodology

considers the overlap between the selected radii and the census blocks (for U.S. Census demographics) and census block groups (for ACS demographics) in determining the demographics surrounding the facility. For more detail about this methodology, see the DFR Data Dictionary <<https://epa.gov/help/reports/dfr-data-dictionary#demographic>>.

General Statistics (U.S. Census)	
Total Persons	7,861
Population Density	2,570/sq.mi.
Housing Units in Area	3,156

General Statistics (ACS (American Community Survey))	
Total Persons	8,658
Percent People of Color	100%
Households in Area	2,954
Households on Public Assistance	117
Persons With Low Income	5,006
Percent With Low Income	58%

Geography	
Radius of Selected Area	1 mi.
Center Latitude	18.37822
Center Longitude	-65.89894
Land Area	99%
Water Area	1%

Income Breakdown (ACS (American Community Survey)) - Households (%)	
Less than \$15,000	651 (22.04%)
\$15,000 - \$25,000	502 (16.99%)
\$25,000 - \$50,000	799 (27.05%)
\$50,000 - \$75,000	396 (13.41%)
Greater than \$75,000	606 (20.51%)

Age Breakdown (U.S. Census) - Persons (%)	
Children 5 years and younger	515 (7%)
Minors 17 years and younger	2,206 (28%)
Adults 18 years and older	5,656 (72%)
Seniors 65 years and older	898 (11%)

Race Breakdown (U.S. Census) - Persons (%)	
White	5,053 (64%)
African-American	1,657 (21%)
Hispanic-Origin	7,810 (99%)
Asian/Pacific Islander	15 (0%)
American Indian	51 (1%)
Other/Multiracial	1,086 (14%)

Education Level (Persons 25 & older) (ACS (American Community Survey)) - Persons (%)	
Less than 9th Grade	556 (9.15%)
9th through 12th Grade	302 (4.97%)
High School Diploma	1,372 (22.58%)
Some College/2-year	788 (12.97%)
B.S./B.A. (Bachelor of Science/Bachelor of Arts) or More	2,114 (34.8%)

Showing reports 1 to 2 of 2



Detailed Facility Report

Facility Summary

ALUMINUM EXTRUSION CORP

PR-185 KM 0.65, CANOVANAS, PR 00729

FRS (Facility Registry Service) ID: 110007805688

EPA Region: 02

Latitude: 18.373702

Longitude: -65.899955

Locational Data Source: TRIS

Industries: Fabricated Metal Product Manufacturing

Indian Country: N

Enforcement and Compliance Summary

Statute	RCRA
Compliance Monitoring Activities (5 years)	--
Date of Last Compliance Monitoring Activity	01/21/2004
Compliance Status	No Violation Identified
Qtrs in Noncompliance (of 12)	0
Qtrs with Significant Violation	0
Informal Enforcement Actions (5 years)	--
Formal Enforcement Actions (5 years)	--
Penalties from Formal Enforcement Actions (5 years)	--
EPA Cases (5 years)	--
Penalties from EPA Cases (5 years)	--

Regulatory Information

Clean Air Act (CAA): No Information

Clean Water Act (CWA): No Information

Resource Conservation and Recovery Act (RCRA): Inactive Other, (PRD090000068), Inactive Other, (PRN008011124)

Safe Drinking Water Act (SDWA): No Information

Other Regulatory Reports

Air Emissions Inventory (EIS): No Information

Greenhouse Gas Emissions (eGGRT): No Information

Toxic Releases (TRI): 00629LMNMP185RO

Compliance and Emissions Data Reporting Interface (CEDRI): No Information

Go To Enforcement/Compliance Details

Known Data Problems <<https://epa.gov/resources/echo-data/known-data-problems>>

Facility/System Characteristics

Facility/System Characteristics

System	Statute	Identifier	Universe	Status	Areas	Permit Expiration Date	Indian Country	Latitude	Longitude
FRS		110007805688					N	18.373702	-65.899955
TRI	EP313	00629LMNMP185RO	Toxics Release Inventory	Last Reported for 1992			N	18.373702	-65.899955
RCRAInfo	RCRA	PRD090000068	Other	Inactive ()			N	18.373702	-65.899955
RCRAInfo	RCRA	PRN008011124	Other	Inactive ()			N	18.373702	-65.899955

Facility Address

System	Statute	Identifier	Facility Name	Facility Address	Facility County
FRS		110007805688	ALUMINUM EXTRUSSION CORP	PR-185 KM 0.65, CANOVANAS, PR 00729	Canóvanas Municipio
TRI	EP313	00629LMNMP185RO	ALUMINUM PROCESSING CORP	185 STATE RD KM 065, CANOVANAS, PR 00729	Canóvanas Municipio
RCRAInfo	RCRA	PRD090000068	ALUMINUM EXTRUSSION CORP	RD 185 KM 0.65, CANOVANAS, PR 00629	Canóvanas Municipio
RCRAInfo	RCRA	PRN008011124	PERFILES DE ALUMINIO	STATE RD 185 KM 0.65, CANOVANAS, PR 00729-1622	Canóvanas Municipio

Facility SIC (Standard Industrial Classification) Codes

System	Identifier	SIC Code	SIC Description
No data records returned			

Facility NAICS (North American Industry Classification System) Codes

System	Identifier	NAICS Code	NAICS Description
TRI	00629LMNMP185RO	332813	Electroplating, Plating, Polishing, Anodizing, and Coloring
RCRAInfo	PRD090000068	331316	Aluminum Extruded Product Manufacturing

Facility Tribe Information

Reservation Name	Tribe Name	EPA Tribal ID	Distance to Tribe (miles)
No data records returned			

Enforcement and Compliance

Compliance Monitoring History Last 5 Years

Statute	Source ID	System	Activity Type	Compliance Monitoring Type	Lead Agency	Date	Finding (if applicable)
No data records returned							

Entries in italics are not included in ECHO's Compliance Monitoring Activity counts because they are not compliance monitoring strategy <<https://www.epa.gov/compliance/compliance-monitoring-programs>> activities or because they are not counted as inspections within EPA's Annual Results <<https://www.epa.gov/enforcement/enforcement-data-and-results>>.

Compliance Summary Data

Statute	Source ID	Current SNC (Significant Noncompliance)/HPV (High Priority Violation)	Current As Of	Qtrs with NC (Noncompliance) (of 12)	Data Last Refreshed
RCRA	PRD090000068	No	07/20/2024	0	07/19/2024
RCRA	PRN008011124	No	07/20/2024	0	07/19/2024

Three-Year Compliance History by Quarter

Statute	Program/Pollutant/Violation Type	QTR 1	QTR 2	QTR 3	QTR 4	QTR 5	QTR 6	QTR 7	QTR 8	QTR 9	QTR 10	QTR 11
RCRA (Source ID: PRD090000068)		10/01-12/31/21	01/01-03/31/22	04/01-06/30/22	07/01-09/30/22	10/01-12/31/22	01/01-03/31/23	04/01-06/30/23	07/01-09/30/23	10/01-12/31/23	01/01-03/31/24	04/01-06/30/24
	Facility-Level Status	No Violation Identified	No Violation Identified	No Violation Identified	No Violation Identified	No Violation Identified	No Violation Identified	No Violation Identified	No Violation Identified	No Violation Identified	No Violation Identified	No Violation Identified
	Violation	Agency										
RCRA (Source ID: PRN008011124)		10/01-12/31/21	01/01-03/31/22	04/01-06/30/22	07/01-09/30/22	10/01-12/31/22	01/01-03/31/23	04/01-06/30/23	07/01-09/30/23	10/01-12/31/23	01/01-03/31/24	04/01-06/30/24
	Facility-Level Status	No Violation Identified	No Violation Identified	No Violation Identified	No Violation Identified	No Violation Identified	No Violation Identified	No Violation Identified	No Violation Identified	No Violation Identified	No Violation Identified	No Violation Identified
	Violation	Agency										

Informal Enforcement Actions Last 5 Years

Statute	System	Source ID	Type of Action	Lead Agency	Date
No data records returned					

Entries in italics are not counted as "informal enforcement actions" in EPA policies pertaining to enforcement response tools.

Formal Enforcement Actions Last 5 Years

Statute	System	Law/Section	Source ID	Type of Action	Case No.	Lead Agency	Case Name	Issued/ Filed Date	Settlements/ Actions	Settlement/ Action Date	Federal Penalty Assessed	State/ Local Penalty Assessed	Penalty Amount Collected	SEP Value	Comp Action Cost
No data records returned															

Environmental Conditions

Watersheds

12-Digit WBD (Watershed Boundary Dataset) HUC (Reach Address Database)	WBD (Watershed Boundary Dataset) Subwatershed Name (RAD (Reach Address Database))	State Water Body Name (ICIS (Integrated Compliance Information System))	Beach Closures Within Last Year	Beach Closures Within Last Two Years	Pollutants Potentially Related to Impairment	Watershed with ESA (Endangered Species Act)-listed Aquatic Species?
--	---	---	---------------------------------	--------------------------------------	--	---

No data records returned

Assessed Waters From Latest State Submission (ATTAINS)

State	Report Cycle	Assessment Unit ID	Assessment Unit Name	Water Condition	Cause Groups Impaired	Drinking Water Use	Ecological Use	Fish Consumption Use	Recreation Use	Other Use
-------	--------------	--------------------	----------------------	-----------------	-----------------------	--------------------	----------------	----------------------	----------------	-----------

No data records returned

Air Quality Nonattainment Areas

Pollutant	Within Nonattainment Status Area?	Nonattainment Status Applicable Standard(s)	Within Maintenance Status Area?	Maintenance Status Applicable Standard(s)
-----------	-----------------------------------	---	---------------------------------	---

No data records returned

Pollutants

Toxics Release Inventory History of Reported Chemicals Released or Transferred in Pounds per Year at Site

TRI Facility ID	Year	Air Emissions	Surface Water Discharges	Off-Site Transfers to POTWs (Publicly Owned Treatment Works)	Underground Injections	Disposal to Land	Total On-Site Releases	Total Off-Site Transfers
-----------------	------	---------------	--------------------------	--	------------------------	------------------	------------------------	--------------------------

No data records returned

Toxics Release Inventory Total Releases and Transfers in Pounds by Chemical and Year

Chemical Name

No data records returned

Community

Environmental Justice

This section shows indexes from EJScreen, EPA's screening tool for environmental justice (EJ) concerns. EPA uses these indexes to identify geographic areas that may warrant further consideration or analysis for potential EJ concerns. Use of these indexes does not designate an area as an "EJ community" or "EJ facility." EJScreen provides screening level indicators, not a determination of the existence or absence of EJ concerns. For more information, see the EJScreen home page.

Potential Environmental Justice Concerns

- US Territory
- Supplemental/EJ index percentiles >= 90 (1-mile average)

EJScreen Indexes Shown

Index Type

Related Reports

EJScreen Community Report

Download Data

Census Block Group ID: 720291005041	US (Percentile)			State (Percentile)		
	Supplemental Indexes	Facility Census Block Group	1-mile Avg	1-mile Max	Facility Census Block Group	1-mile Avg
Count of Indexes At or Above 90th Percentile	0	3	7	0	0	4
Particulate Matter 2.5	--	N/A	--	--	N/A	--
Ozone	--	N/A	--	--	N/A	--
Diesel Particulate Matter	0	4	9	10	26	56
Air Toxics Cancer Risk	47	33	57	21	0	96
Air Toxics Respiratory Hazard Index	29	31	43	23	29	96
Toxic Releases to Air	89	97	99	42	65	99
Traffic Proximity	81	94	99	32	54	96

Census Block Group ID: 720291005041	US (Percentile)			State (Percentile)		
	Facility Census Block Group	1-mile Avg	1-mile Max	Facility Census Block Group	1-mile Avg	1-mile Max
Lead Paint	43	53	99	20	22	94
Risk Management Plan (RMP) Facility Proximity	49	57	86	12	15	38
Hazardous Waste Proximity	71	85	99	24	42	92
Superfund Proximity	84	88	99	28	29	44
Underground Storage Tanks (UST)	76	76	99	62	61	94
Wastewater Discharge	89	92	99	36	38	75

Map Display Based on: US State

Display Map Layer

Facility 1-mile Radius Facility Census Block Group



Powered by Esri <<http://www.esri.com/>>

Demographic Profile of Surrounding Area (1-Mile Radius)

This section provides demographic information regarding the community surrounding the facility. ECHO compliance data alone are not sufficient to determine whether violations at a particular facility had negative impacts on public health or the environment. Statistics are based upon the 2010 U.S. Census and 2017 - 2021 American Community Survey (ACS) 5-year Summary and are accurate to the extent that the facility latitude and longitude listed below are correct. Census boundaries and demographic data for U.S. Territories are based on the "2020 Island Areas Demographic Profiles" from the U.S. Census Bureau. EPA's spatial processing methodology considers the overlap between the selected radii and the census blocks (for U.S. Census demographics) and census block groups (for ACS demographics) in determining the demographics surrounding the facility. For more detail about this methodology, see the DFR Data Dictionary <<https://epa.gov/help/reports/dfr-data-dictionary#demographic>>.

General Statistics (U.S. Census)	
Total Persons	10,046
Population Density	3,216/sq.mi.
Housing Units in Area	3,950

General Statistics (ACS (American Community Survey))	
Total Persons	10,085
Percent People of Color	100%
Households in Area	3,311
Households on Public Assistance	118
Persons With Low Income	5,450
Percent With Low Income	54%

Age Breakdown (U.S. Census) - Persons (%)	
Children 5 years and younger	692 (7%)
Minors 17 years and younger	2,843 (28%)
Adults 18 years and older	7,203 (72%)
Seniors 65 years and older	1,124 (11%)

Race Breakdown (U.S. Census) - Persons (%)	
White	6,642 (66%)
African-American	2,000 (20%)
Hispanic-Origin	9,991 (99%)
Asian/Pacific Islander	23 (0%)
American Indian	62 (1%)
Other/Multiracial	1,320 (13%)

Geography	
Radius of Selected Area	1 mi.
Center Latitude	18.373702
Center Longitude	-65.899955
Land Area	99%
Water Area	1%

Income Breakdown (ACS (American Community Survey)) - Households (%)	
Less than \$15,000	589 (17.79%)
\$15,000 - \$25,000	501 (15.14%)
\$25,000 - \$50,000	947 (28.61%)
\$50,000 - \$75,000	516 (15.59%)
Greater than \$75,000	757 (22.87%)

Education Level (Persons 25 & older) (ACS (American Community Survey)) - Persons (%)	
Less than 9th Grade	444 (6.27%)
9th through 12th Grade	314 (4.44%)
High School Diploma	1,571 (22.2%)
Some College/2-year	954 (13.48%)
B.S./B.A. (Bachelor of Science/Bachelor of Arts) or More	2,675 (37.8%)



Detailed Facility Report

Facility Summary

ALUMINUM EXTRUSION CORPORATION

STATE ROAD 185 KM. 0.65, CANOVANAS MUNICIPALITY, PR 00729

FRS (Facility Registry Service) ID: 110071099921

EPA Region: 02

Latitude: 18.375556

Longitude: -65.898889

Locational Data Source: SEMS

Industries: --

Indian Country: N

Enforcement and Compliance Summary

No data records returned

Regulatory Information

Clean Air Act (CAA): No Information

Clean Water Act (CWA): No Information

Resource Conservation and Recovery Act (RCRA): No Information

Safe Drinking Water Act (SDWA): No Information

Other Regulatory Reports

Air Emissions Inventory (EIS): No Information

Greenhouse Gas Emissions (eGGRT): No Information

Toxic Releases (TRI): No Information

Compliance and Emissions Data Reporting Interface (CEDRI): No Information

Go To Enforcement/Compliance Details

Known Data Problems <<https://epa.gov/resources/echo-data/known-data-problems>>

Facility/System Characteristics

Facility/System Characteristics

System	Statute	Identifier	Universe	Status	Areas	Permit Expiration Date	Indian Country	Latitude	Longitude
FRS		110071099921					N	18.375556	-65.898889
SEMS	CERCLA	PRD090000068		NOT ON THE NPL			N	18.375556	-65.898889

Facility Address

System	Statute	Identifier	Facility Name	Facility Address	Facility County
FRS		110071099921	ALUMINUM EXTRUSION CORPORATION	STATE ROAD 185 KM. 0.65, CANOVANAS MUNICIPALITY, PR 00729	Canóvanas Municipio

System	Statute	Identifier	Facility Name	Facility Address	Facility County
SEMS	CERCLA	PRD090000068	ALUMINUM EXTRUSION CORPORATION	STATE ROAD 185 KM. 0.65, CANOVANAS MUNICIPALITY, PR 00729	

Facility SIC (Standard Industrial Classification) Codes

System	Identifier	SIC Code	SIC Description
--------	------------	----------	-----------------

No data records returned

Facility NAICS (North American Industry Classification System) Codes

System	Identifier	NAICS Code	NAICS Description
--------	------------	------------	-------------------

No data records returned

Facility Tribe Information

Reservation Name	Tribe Name	EPA Tribal ID	Distance to Tribe (miles)
------------------	------------	---------------	---------------------------

No data records returned

Enforcement and Compliance

Compliance Monitoring History Last 5 Years

Statute	Source ID	System	Activity Type	Compliance Monitoring Type	Lead Agency	Date	Finding (if applicable)
---------	-----------	--------	---------------	----------------------------	-------------	------	-------------------------

No data records returned

Entries in italics are not included in ECHO's Compliance Monitoring Activity counts because they are not compliance monitoring strategy
 <<https://www.epa.gov/compliance/compliance-monitoring-programs>> activities or because they are not counted as inspections within EPA's Annual Results
 <<https://www.epa.gov/enforcement/enforcement-data-and-results>>.

Compliance Summary Data

Statute	Source ID	Current SNC (Significant Noncompliance)/HPV (High Priority Violation)	Current As Of	Qtrs with NC (Noncompliance) (of 12)	Data Last Refreshed
---------	-----------	---	---------------	--------------------------------------	---------------------

No data records returned

Three-Year Compliance History by Quarter

Informal Enforcement Actions Last 5 Years

Statute	System	Source ID	Type of Action	Lead Agency	Date
---------	--------	-----------	----------------	-------------	------

No data records returned

Entries in italics are not counted as "informal enforcement actions" in EPA policies pertaining to enforcement response tools.

Formal Enforcement Actions Last 5 Years

Statute	System	Law/Section	Source ID	Type of Action	Case No.	Lead Agency	Case Name	Issued/ Filed Date	Settlements/ Actions	Settlement/ Action Date	Federal Penalty Assessed	State/ Local Penalty Assessed	Penalty Amount Collected	SEP Value	Comp Action Cost
---------	--------	-------------	-----------	----------------	----------	-------------	-----------	--------------------	----------------------	-------------------------	--------------------------	-------------------------------	--------------------------	-----------	------------------

No data records returned

Environmental Conditions

Watersheds

12-Digit WBD (Watershed Boundary Dataset) HUC (RAD (Reach Address Database))	WBD (Watershed Boundary Dataset) Subwatershed Name (RAD (Reach Address Database))	State Water Body Name (ICIS (Integrated Compliance Information System))	Beach Closures Within Last Year	Beach Closures Within Last Two Years	Pollutants Potentially Related to Impairment	Watershed with ESA (Endangered Species Act)-listed Aquatic Species?
--	---	---	---------------------------------	--------------------------------------	--	---

No data records returned

Assessed Waters From Latest State Submission (ATTAINS)

State	Report Cycle	Assessment Unit ID	Assessment Unit Name	Water Condition	Cause Groups Impaired	Drinking Water Use	Ecological Use	Fish Consumption Use	Recreation Use	Other Use
-------	--------------	--------------------	----------------------	-----------------	-----------------------	--------------------	----------------	----------------------	----------------	-----------

No data records returned

Air Quality Nonattainment Areas

Pollutant	Within Nonattainment Status Area?	Nonattainment Status Applicable Standard(s)	Within Maintenance Status Area?	Maintenance Status Applicable Standard(s)
-----------	-----------------------------------	---	---------------------------------	---

No data records returned

Pollutants

Toxics Release Inventory History of Reported Chemicals Released or Transferred in Pounds per Year at Site

TRI Facility ID Year Air Emissions Surface Water Discharges Off-Site Transfers to POTWs (Publicly Owned Treatment Works) Underground Injections Disposal to Land Total On-Site Releases Total Off-Site Transfers

No data records returned

Toxics Release Inventory Total Releases and Transfers in Pounds by Chemical and Year

Chemical Name

No data records returned

Community

Environmental Justice

This section shows indexes from EJScreen, EPA's screening tool for environmental justice (EJ) concerns. EPA uses these indexes to identify geographic areas that may warrant further consideration or analysis for potential EJ concerns. Use of these indexes does not designate an area as an "EJ community" or "EJ facility." EJScreen provides screening level indicators, not a determination of the existence or absence of EJ concerns. For more information, see the EJScreen home page.

Potential Environmental Justice Concerns

- US Territory
- Supplemental/EJ index percentiles >= 90 (Census block group)
- Supplemental/EJ index percentiles >= 90 (1-mile average)

EJScreen Indexes Shown

Index Type

Related Reports

EJScreen Community Report

Download Data

Census Block Group ID: 720291002002	US (Percentile)			State (Percentile)		
	Supplemental Indexes	Facility Census Block Group	1-mile Avg	1-mile Max	Facility Census Block Group	1-mile Avg
Count of indexes At or Above 90th Percentile	5	3	7	0	0	4
Particulate Matter 2.5	--	N/A	--	--	N/A	--
Ozone	--	N/A	--	--	N/A	--
Diesel Particulate Matter	3	3	9	32	25	56
Air Toxics Cancer Risk	51	50	57	34	26	96
Air Toxics Respiratory Hazard Index	32	30	43	36	28	96
Toxic Releases to Air	99	96	99	76	64	99
Traffic Proximity	99	93	99	79	53	96
Lead Paint	56	55	99	22	23	94
Risk Management Plan (RMP) Facility Proximity	60	56	86	15	14	38
Hazardous Waste Proximity	87	83	99	45	40	92
Superfund Proximity	91	87	99	32	29	44
Underground Storage Tanks (UST)	97	79	99	75	62	94
Wastewater Discharge	97	92	99	53	39	75

Map Display Based on: US State

Display Map Layer

Facility 1-mile Radius Facility Census Block Group



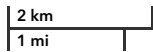

Powered by Esri <<http://www.esri.com/>>

Demographic Profile of Surrounding Area (1-Mile Radius)

This section provides demographic information regarding the community surrounding the facility. ECHO compliance data alone are not sufficient to determine whether violations at a particular facility had negative impacts on public health or the environment. Statistics are based upon the 2010 U.S. Census and 2017 - 2021 American Community Survey (ACS) 5-year Summary and are accurate to the extent that the facility latitude and longitude listed below are correct. Census boundaries and demographic data for U.S. Territories are based on the "2020 Island Areas Demographic Profiles" from the U.S. Census Bureau. EPA's spatial processing methodology considers the overlap between the selected radii and the census blocks (for U.S. Census demographics) and census block groups (for ACS demographics) in determining the demographics surrounding the facility. For more detail about this methodology, see the DFR Data Dictionary <<https://epa.gov/help/reports/dfr-data-dictionary#demographic>>.

General Statistics (U.S. Census)	
Total Persons	9,042
Population Density	2,966/sq.mi.
Housing Units in Area	3,558

General Statistics (ACS (American Community Survey))	
Total Persons	9,409
Percent People of Color	100%
Households in Area	3,112
Households on Public Assistance	117
Persons With Low Income	5,068
Percent With Low Income	54%

Geography	
Radius of Selected Area	1 mi.
Center Latitude	18.375556
Center Longitude	-65.898889
Land Area	99%
Water Area	1%

Income Breakdown (ACS (American Community Survey)) - Households (%)	
Less than \$15,000	592 (19.04%)
\$15,000 - \$25,000	467 (15.02%)
\$25,000 - \$50,000	854 (27.47%)
\$50,000 - \$75,000	469 (15.09%)
Greater than \$75,000	727 (23.38%)

Age Breakdown (U.S. Census) - Persons (%)	
Children 5 years and younger	623 (7%)
Minors 17 years and younger	2,582 (29%)
Adults 18 years and older	6,460 (71%)
Seniors 65 years and older	979 (11%)

Race Breakdown (U.S. Census) - Persons (%)	
White	5,976 (66%)
African-American	1,808 (20%)
Hispanic-Origin	8,996 (99%)
Asian/Pacific Islander	21 (0%)
American Indian	57 (1%)
Other/Multiracial	1,180 (13%)

Education Level (Persons 25 & older) (ACS (American Community Survey)) - Persons (%)	
Less than 9th Grade	428 (6.54%)
9th through 12th Grade	300 (4.59%)
High School Diploma	1,414 (21.62%)
Some College/2-year	872 (13.33%)
B.S./B.A. (Bachelor of Science/Bachelor of Arts) or More	2,479 (37.91%)

Showing reports 1 to 2 of 2



Detailed Facility Report

Facility Summary

ALUMINUM EXTRUSION CORP

PR-185 KM 0.65, CANOVANAS, PR 00729

FRS (Facility Registry Service) ID: 110007805688

EPA Region: 02

Latitude: 18.373702

Longitude: -65.899955

Locational Data Source: TRIS

Industries: Fabricated Metal Product Manufacturing

Indian Country: N

Enforcement and Compliance Summary

Statute	RCRA
Compliance Monitoring Activities (5 years)	--
Date of Last Compliance Monitoring Activity	01/21/2004
Compliance Status	No Violation Identified
Qtrs in Noncompliance (of 12)	0
Qtrs with Significant Violation	0
Informal Enforcement Actions (5 years)	--
Formal Enforcement Actions (5 years)	--
Penalties from Formal Enforcement Actions (5 years)	--
EPA Cases (5 years)	--
Penalties from EPA Cases (5 years)	--

Regulatory Information

Clean Air Act (CAA): No Information

Clean Water Act (CWA): No Information

Resource Conservation and Recovery Act (RCRA): Inactive Other, (PRD090000068), Inactive Other, (PRN008011124)

Safe Drinking Water Act (SDWA): No Information

Other Regulatory Reports

Air Emissions Inventory (EIS): No Information

Greenhouse Gas Emissions (eGGRT): No Information

Toxic Releases (TRI): 00629LMNMP185RO

Compliance and Emissions Data Reporting Interface (CEDRI): No Information

Go To Enforcement/Compliance Details

Known Data Problems <<https://epa.gov/resources/echo-data/known-data-problems>>

Facility/System Characteristics

Facility/System Characteristics

System	Statute	Identifier	Universe	Status	Areas	Permit Expiration Date	Indian Country	Latitude	Longitude
FRS		110007805688					N	18.373702	-65.899955
TRI	EP313	00629LMNMP185RO	Toxics Release Inventory	Last Reported for 1992			N	18.373702	-65.899955
RCRAInfo	RCRA	PRD090000068	Other	Inactive ()			N	18.373702	-65.899955
RCRAInfo	RCRA	PRN008011124	Other	Inactive ()			N	18.373702	-65.899955

Facility Address

System	Statute	Identifier	Facility Name	Facility Address	Facility County
FRS		110007805688	ALUMINUM EXTRUSSION CORP	PR-185 KM 0.65, CANOVANAS, PR 00729	Canóvanas Municipio
TRI	EP313	00629LMNMP185RO	ALUMINUM PROCESSING CORP	185 STATE RD KM 065, CANOVANAS, PR 00729	Canóvanas Municipio
RCRAInfo	RCRA	PRD090000068	ALUMINUM EXTRUSSION CORP	RD 185 KM 0.65, CANOVANAS, PR 00629	Canóvanas Municipio
RCRAInfo	RCRA	PRN008011124	PERFILES DE ALUMINIO	STATE RD 185 KM 0.65, CANOVANAS, PR 00729-1622	Canóvanas Municipio

Facility SIC (Standard Industrial Classification) Codes

System	Identifier	SIC Code	SIC Description
No data records returned			

Facility NAICS (North American Industry Classification System) Codes

System	Identifier	NAICS Code	NAICS Description
TRI	00629LMNMP185RO	332813	Electroplating, Plating, Polishing, Anodizing, and Coloring
RCRAInfo	PRD090000068	331316	Aluminum Extruded Product Manufacturing

Facility Tribe Information

Reservation Name	Tribe Name	EPA Tribal ID	Distance to Tribe (miles)
No data records returned			

Enforcement and Compliance

Compliance Monitoring History Last 5 Years

Statute	Source ID	System	Activity Type	Compliance Monitoring Type	Lead Agency	Date	Finding (if applicable)
No data records returned							

Entries in italics are not included in ECHO's Compliance Monitoring Activity counts because they are not compliance monitoring strategy <<https://www.epa.gov/compliance/compliance-monitoring-programs>> activities or because they are not counted as inspections within EPA's Annual Results <<https://www.epa.gov/enforcement/enforcement-data-and-results>>.

Compliance Summary Data

Statute	Source ID	Current SNC (Significant Noncompliance)/HPV (High Priority Violation)	Current As Of	Qtrs with NC (Noncompliance) (of 12)	Data Last Refreshed
RCRA	PRD090000068	No	07/20/2024	0	07/19/2024
RCRA	PRN008011124	No	07/20/2024	0	07/19/2024

Three-Year Compliance History by Quarter

Statute	Program/Pollutant/Violation Type	QTR 1	QTR 2	QTR 3	QTR 4	QTR 5	QTR 6	QTR 7	QTR 8	QTR 9	QTR 10	QTR 11
RCRA (Source ID: PRD090000068)		10/01-12/31/21	01/01-03/31/22	04/01-06/30/22	07/01-09/30/22	10/01-12/31/22	01/01-03/31/23	04/01-06/30/23	07/01-09/30/23	10/01-12/31/23	01/01-03/31/24	04/01-06/30/24
	Facility-Level Status	No Violation Identified	No Violation Identified	No Violation Identified	No Violation Identified	No Violation Identified	No Violation Identified	No Violation Identified	No Violation Identified	No Violation Identified	No Violation Identified	No Violation Identified
	Violation Agency											
RCRA (Source ID: PRN008011124)		10/01-12/31/21	01/01-03/31/22	04/01-06/30/22	07/01-09/30/22	10/01-12/31/22	01/01-03/31/23	04/01-06/30/23	07/01-09/30/23	10/01-12/31/23	01/01-03/31/24	04/01-06/30/24
	Facility-Level Status	No Violation Identified	No Violation Identified	No Violation Identified	No Violation Identified	No Violation Identified	No Violation Identified	No Violation Identified	No Violation Identified	No Violation Identified	No Violation Identified	No Violation Identified
	Violation Agency											

Informal Enforcement Actions Last 5 Years

Statute	System	Source ID	Type of Action	Lead Agency	Date
No data records returned					

Entries in italics are not counted as "informal enforcement actions" in EPA policies pertaining to enforcement response tools.

Formal Enforcement Actions Last 5 Years

Statute	System	Law/Section	Source ID	Type of Action	Case No.	Lead Agency	Case Name	Issued/ Filed Date	Settlements/ Actions	Settlement/ Action Date	Federal Penalty Assessed	State/ Local Penalty Assessed	Penalty Amount Collected	SEP Value	Comp Action Cost
No data records returned															

Environmental Conditions

Watersheds

12-Digit WBD (Watershed Boundary Dataset) HUC (Reach Address Database)	WBD (Watershed Boundary Dataset) Subwatershed Name (RAD (Reach Address Database))	State Water Body Name (ICIS (Integrated Compliance Information System))	Beach Closures Within Last Year	Beach Closures Within Last Two Years	Pollutants Potentially Related to Impairment	Watershed with ESA (Endangered Species Act)-listed Aquatic Species?
--	---	---	---------------------------------	--------------------------------------	--	---

No data records returned

Assessed Waters From Latest State Submission (ATTAINS)

State	Report Cycle	Assessment Unit ID	Assessment Unit Name	Water Condition	Cause Groups Impaired	Drinking Water Use	Ecological Use	Fish Consumption Use	Recreation Use	Other Use
-------	--------------	--------------------	----------------------	-----------------	-----------------------	--------------------	----------------	----------------------	----------------	-----------

No data records returned

Air Quality Nonattainment Areas

Pollutant	Within Nonattainment Status Area?	Nonattainment Status Applicable Standard(s)	Within Maintenance Status Area?	Maintenance Status Applicable Standard(s)
-----------	-----------------------------------	---	---------------------------------	---

No data records returned

Pollutants

Toxics Release Inventory History of Reported Chemicals Released or Transferred in Pounds per Year at Site

TRI Facility ID	Year	Air Emissions	Surface Water Discharges	Off-Site Transfers to POTWs (Publicly Owned Treatment Works)	Underground Injections	Disposal to Land	Total On-Site Releases	Total Off-Site Transfers
-----------------	------	---------------	--------------------------	--	------------------------	------------------	------------------------	--------------------------

No data records returned

Toxics Release Inventory Total Releases and Transfers in Pounds by Chemical and Year

Chemical Name

No data records returned

Community

Environmental Justice

This section shows indexes from EJScreen, EPA's screening tool for environmental justice (EJ) concerns. EPA uses these indexes to identify geographic areas that may warrant further consideration or analysis for potential EJ concerns. Use of these indexes does not designate an area as an "EJ community" or "EJ facility." EJScreen provides screening level indicators, not a determination of the existence or absence of EJ concerns. For more information, see the EJScreen home page.

Potential Environmental Justice Concerns

- US Territory
- Supplemental/EJ index percentiles >= 90 (1-mile average)

EJScreen Indexes Shown

Index Type

Related Reports

EJScreen Community Report

Download Data

Census Block Group ID: 720291005041	US (Percentile)			State (Percentile)		
	Supplemental Indexes	Facility Census Block Group	1-mile Avg	1-mile Max	Facility Census Block Group	1-mile Avg
Count of Indexes At or Above 90th Percentile	0	3	7	0	0	4
Particulate Matter 2.5	--	N/A	--	--	N/A	--
Ozone	--	N/A	--	--	N/A	--
Diesel Particulate Matter	0	4	9	10	26	56
Air Toxics Cancer Risk	47	33	57	21	0	96
Air Toxics Respiratory Hazard Index	29	31	43	23	29	96
Toxic Releases to Air	89	97	99	42	65	99
Traffic Proximity	81	94	99	32	54	96

Census Block Group ID: 720291005041	US (Percentile)			State (Percentile)		
	Facility Census Block Group	1-mile Avg	1-mile Max	Facility Census Block Group	1-mile Avg	1-mile Max
Lead Paint	43	53	99	20	22	94
Risk Management Plan (RMP) Facility Proximity	49	57	86	12	15	38
Hazardous Waste Proximity	71	85	99	24	42	92
Superfund Proximity	84	88	99	28	29	44
Underground Storage Tanks (UST)	76	76	99	62	61	94
Wastewater Discharge	89	92	99	36	38	75

Map Display Based on: US State

Display Map Layer

Facility 1-mile Radius Facility Census Block Group



Powered by Esri <<http://www.esri.com/>>

Demographic Profile of Surrounding Area (1-Mile Radius)

This section provides demographic information regarding the community surrounding the facility. ECHO compliance data alone are not sufficient to determine whether violations at a particular facility had negative impacts on public health or the environment. Statistics are based upon the 2010 U.S. Census and 2017 - 2021 American Community Survey (ACS) 5-year Summary and are accurate to the extent that the facility latitude and longitude listed below are correct. Census boundaries and demographic data for U.S. Territories are based on the "2020 Island Areas Demographic Profiles" from the U.S. Census Bureau. EPA's spatial processing methodology considers the overlap between the selected radii and the census blocks (for U.S. Census demographics) and census block groups (for ACS demographics) in determining the demographics surrounding the facility. For more detail about this methodology, see the DFR Data Dictionary <<https://epa.gov/help/reports/dfr-data-dictionary#demographic>>.

General Statistics (U.S. Census)	
Total Persons	10,046
Population Density	3,216/sq.mi.
Housing Units in Area	3,950

General Statistics (ACS (American Community Survey))	
Total Persons	10,085
Percent People of Color	100%
Households in Area	3,311
Households on Public Assistance	118
Persons With Low Income	5,450
Percent With Low Income	54%

Age Breakdown (U.S. Census) - Persons (%)	
Children 5 years and younger	692 (7%)
Minors 17 years and younger	2,843 (28%)
Adults 18 years and older	7,203 (72%)
Seniors 65 years and older	1,124 (11%)

Race Breakdown (U.S. Census) - Persons (%)	
White	6,642 (66%)
African-American	2,000 (20%)
Hispanic-Origin	9,991 (99%)
Asian/Pacific Islander	23 (0%)
American Indian	62 (1%)
Other/Multiracial	1,320 (13%)

Geography	
Radius of Selected Area	1 mi.
Center Latitude	18.373702
Center Longitude	-65.899955
Land Area	99%
Water Area	1%

Education Level (Persons 25 & older) (ACS (American Community Survey)) - Persons (%)	
Less than 9th Grade	444 (6.27%)
9th through 12th Grade	314 (4.44%)
High School Diploma	1,571 (22.2%)
Some College/2-year	954 (13.48%)
B.S./B.A. (Bachelor of Science/Bachelor of Arts) or More	2,675 (37.8%)

Income Breakdown (ACS (American Community Survey)) - Households (%)	
Less than \$15,000	589 (17.79%)
\$15,000 - \$25,000	501 (15.14%)
\$25,000 - \$50,000	947 (28.61%)
\$50,000 - \$75,000	516 (15.59%)
Greater than \$75,000	757 (22.87%)



Detailed Facility Report

Facility Summary

ALUMINUM EXTRUSION CORPORATION

STATE ROAD 185 KM. 0.65, CANOVANAS MUNICIPALITY, PR 00729

FRS (Facility Registry Service) ID: 110071099921

EPA Region: 02

Latitude: 18.375556

Longitude: -65.898889

Locational Data Source: SEMS

Industries: --

Indian Country: N

Enforcement and Compliance Summary

No data records returned

Regulatory Information

Clean Air Act (CAA): No Information

Clean Water Act (CWA): No Information

Resource Conservation and Recovery Act (RCRA): No Information

Safe Drinking Water Act (SDWA): No Information

Other Regulatory Reports

Air Emissions Inventory (EIS): No Information

Greenhouse Gas Emissions (eGGRT): No Information

Toxic Releases (TRI): No Information

Compliance and Emissions Data Reporting Interface (CEDRI): No Information

Go To Enforcement/Compliance Details

Known Data Problems <<https://epa.gov/resources/echo-data/known-data-problems>>

Facility/System Characteristics

Facility/System Characteristics

System	Statute	Identifier	Universe	Status	Areas	Permit Expiration Date	Indian Country	Latitude	Longitude
FRS		110071099921					N	18.375556	-65.898889
SEMS	CERCLA	PRD090000068		NOT ON THE NPL			N	18.375556	-65.898889

Facility Address

System	Statute	Identifier	Facility Name	Facility Address	Facility County
FRS		110071099921	ALUMINUM EXTRUSION CORPORATION	STATE ROAD 185 KM. 0.65, CANOVANAS MUNICIPALITY, PR 00729	Canóvanas Municipio

System	Statute	Identifier	Facility Name	Facility Address	Facility County
SEMS	CERCLA	PRD090000068	ALUMINUM EXTRUSION CORPORATION	STATE ROAD 185 KM. 0.65, CANOVANAS MUNICIPALITY, PR 00729	

Facility SIC (Standard Industrial Classification) Codes

System	Identifier	SIC Code	SIC Description
--------	------------	----------	-----------------

No data records returned

Facility NAICS (North American Industry Classification System) Codes

System	Identifier	NAICS Code	NAICS Description
--------	------------	------------	-------------------

No data records returned

Facility Tribe Information

Reservation Name	Tribe Name	EPA Tribal ID	Distance to Tribe (miles)
------------------	------------	---------------	---------------------------

No data records returned

Enforcement and Compliance

Compliance Monitoring History

Last 5 Years

Statute	Source ID	System	Activity Type	Compliance Monitoring Type	Lead Agency	Date	Finding (if applicable)
---------	-----------	--------	---------------	----------------------------	-------------	------	-------------------------

No data records returned

Entries in italics are not included in ECHO's Compliance Monitoring Activity counts because they are not compliance monitoring strategy
 <<https://www.epa.gov/compliance/compliance-monitoring-programs>> activities or because they are not counted as inspections within EPA's Annual Results
 <<https://www.epa.gov/enforcement/enforcement-data-and-results>>.

Compliance Summary Data

Statute	Source ID	Current SNC (Significant Noncompliance)/HPV (High Priority Violation)	Current As Of	Qtrs with NC (Noncompliance) (of 12)	Data Last Refreshed
---------	-----------	---	---------------	--------------------------------------	---------------------

No data records returned

Three-Year Compliance History by Quarter

Informal Enforcement Actions

Last 5 Years

Statute	System	Source ID	Type of Action	Lead Agency	Date
---------	--------	-----------	----------------	-------------	------

No data records returned

Entries in italics are not counted as "informal enforcement actions" in EPA policies pertaining to enforcement response tools.

Formal Enforcement Actions

Last 5 Years

Statute	System	Law/Section	Source ID	Type of Action	Case No.	Lead Agency	Case Name	Issued/ Filed Date	Settlements/ Actions	Settlement/ Action Date	Federal Penalty Assessed	State/ Local Penalty Assessed	Penalty Amount Collected	SEP Value	Comp Action Cost
---------	--------	-------------	-----------	----------------	----------	-------------	-----------	--------------------	----------------------	-------------------------	--------------------------	-------------------------------	--------------------------	-----------	------------------

No data records returned

Environmental Conditions

Watersheds

12-Digit WBD (Watershed Boundary Dataset) HUC (RAD (Reach Address Database))	WBD (Watershed Boundary Dataset) Subwatershed Name (RAD (Reach Address Database))	State Water Body Name (ICIS (Integrated Compliance Information System))	Beach Closures Within Last Year	Beach Closures Within Last Two Years	Pollutants Potentially Related to Impairment	Watershed with ESA (Endangered Species Act)-listed Aquatic Species?
--	---	---	---------------------------------	--------------------------------------	--	---

No data records returned

Assessed Waters From Latest State Submission (ATTAINS)

State	Report Cycle	Assessment Unit ID	Assessment Unit Name	Water Condition	Cause Groups Impaired	Drinking Water Use	Ecological Use	Fish Consumption Use	Recreation Use	Other Use
-------	--------------	--------------------	----------------------	-----------------	-----------------------	--------------------	----------------	----------------------	----------------	-----------

No data records returned

Air Quality Nonattainment Areas

Pollutant	Within Nonattainment Status Area?	Nonattainment Status Applicable Standard(s)	Within Maintenance Status Area?	Maintenance Status Applicable Standard(s)
-----------	-----------------------------------	---	---------------------------------	---

No data records returned

Pollutants

Toxics Release Inventory History of Reported Chemicals Released or Transferred in Pounds per Year at Site

TRI Facility ID Year Air Emissions Surface Water Discharges Off-Site Transfers to POTWs (Publicly Owned Treatment Works) Underground Injections Disposal to Land Total On-Site Releases Total Off-Site Transfers

No data records returned

Toxics Release Inventory Total Releases and Transfers in Pounds by Chemical and Year

Chemical Name

No data records returned

Community

Environmental Justice

This section shows indexes from EJScreen, EPA's screening tool for environmental justice (EJ) concerns. EPA uses these indexes to identify geographic areas that may warrant further consideration or analysis for potential EJ concerns. Use of these indexes does not designate an area as an "EJ community" or "EJ facility." EJScreen provides screening level indicators, not a determination of the existence or absence of EJ concerns. For more information, see the EJScreen home page.

Potential Environmental Justice Concerns

- US Territory
- Supplemental/EJ index percentiles >= 90 (Census block group)
- Supplemental/EJ index percentiles >= 90 (1-mile average)

EJScreen Indexes Shown

Index Type

Related Reports

EJScreen Community Report

Download Data

Census Block Group ID: 720291002002	US (Percentile)			State (Percentile)		
	Supplemental Indexes	Facility Census Block Group	1-mile Avg	1-mile Max	Facility Census Block Group	1-mile Avg
Count of indexes At or Above 90th Percentile	5	3	7	0	0	4
Particulate Matter 2.5	--	N/A	--	--	N/A	--
Ozone	--	N/A	--	--	N/A	--
Diesel Particulate Matter	3	3	9	32	25	56
Air Toxics Cancer Risk	51	50	57	34	26	96
Air Toxics Respiratory Hazard Index	32	30	43	36	28	96
Toxic Releases to Air	99	96	99	76	64	99
Traffic Proximity	99	93	99	79	53	96
Lead Paint	56	55	99	22	23	94
Risk Management Plan (RMP) Facility Proximity	60	56	86	15	14	38
Hazardous Waste Proximity	87	83	99	45	40	92
Superfund Proximity	91	87	99	32	29	44
Underground Storage Tanks (UST)	97	79	99	75	62	94
Wastewater Discharge	97	92	99	53	39	75

Map Display Based on: US State

Display Map Layer

Facility 1-mile Radius Facility Census Block Group



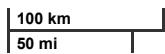

Powered by Esri <<http://www.esri.com/>>

Demographic Profile of Surrounding Area (1-Mile Radius)

This section provides demographic information regarding the community surrounding the facility. ECHO compliance data alone are not sufficient to determine whether violations at a particular facility had negative impacts on public health or the environment. Statistics are based upon the 2010 U.S. Census and 2017 - 2021 American Community Survey (ACS) 5-year Summary and are accurate to the extent that the facility latitude and longitude listed below are correct. Census boundaries and demographic data for U.S. Territories are based on the "2020 Island Areas Demographic Profiles" from the U.S. Census Bureau. EPA's spatial processing methodology considers the overlap between the selected radii and the census blocks (for U.S. Census demographics) and census block groups (for ACS demographics) in determining the demographics surrounding the facility. For more detail about this methodology, see the DFR Data Dictionary <<https://epa.gov/help/reports/df-data-dictionary#demographic>>.

General Statistics (U.S. Census)	
Total Persons	9,042
Population Density	2,966/sq.mi.
Housing Units in Area	3,558

General Statistics (ACS (American Community Survey))	
Total Persons	9,409
Percent People of Color	100%
Households in Area	3,112
Households on Public Assistance	117
Persons With Low Income	5,068
Percent With Low Income	54%

Geography	
Radius of Selected Area	1 mi.
Center Latitude	18.375556
Center Longitude	-65.898889
Land Area	99%
Water Area	1%

Income Breakdown (ACS (American Community Survey)) - Households (%)	
Less than \$15,000	592 (19.04%)
\$15,000 - \$25,000	467 (15.02%)
\$25,000 - \$50,000	854 (27.47%)
\$50,000 - \$75,000	469 (15.09%)
Greater than \$75,000	727 (23.38%)

Age Breakdown (U.S. Census) - Persons (%)	
Children 5 years and younger	623 (7%)
Minors 17 years and younger	2,582 (29%)
Adults 18 years and older	6,460 (71%)
Seniors 65 years and older	979 (11%)

Race Breakdown (U.S. Census) - Persons (%)	
White	5,976 (66%)
African-American	1,808 (20%)
Hispanic-Origin	8,996 (99%)
Asian/Pacific Islander	21 (0%)
American Indian	57 (1%)
Other/Multiracial	1,180 (13%)

Education Level (Persons 25 & older) (ACS (American Community Survey)) - Persons (%)	
Less than 9th Grade	428 (6.54%)
9th through 12th Grade	300 (4.59%)
High School Diploma	1,414 (21.62%)
Some College/2-year	872 (13.33%)
B.S./B.A. (Bachelor of Science/Bachelor of Arts) or More	2,479 (37.91%)



Detailed Facility Report

Facility Summary

AMERICAN PROPERTIES CORP

PR-874 KM 1.1, CANOVANAS, PR 00729

FRS (Facility Registry Service) ID: 110007810495

EPA Region: 02

Latitude: 18.373481

Longitude: -65.900869

Locational Data Source: RCRAINFO

Industries: --

Indian Country: N

Enforcement and Compliance Summary

Statute	RCRA
Compliance Monitoring Activities (5 years)	--
Date of Last Compliance Monitoring Activity	12/22/1998
Compliance Status	No Violation Identified
Qtrs in Noncompliance (of 12)	0
Qtrs with Significant Violation	0
Informal Enforcement Actions (5 years)	--
Formal Enforcement Actions (5 years)	--
Penalties from Formal Enforcement Actions (5 years)	--
EPA Cases (5 years)	--
Penalties from EPA Cases (5 years)	--

Regulatory Information

Clean Air Act (CAA): No Information

Clean Water Act (CWA): No Information

Resource Conservation and Recovery Act (RCRA): Inactive Other, (PRD987369675)

Safe Drinking Water Act (SDWA): No Information

Other Regulatory Reports

Air Emissions Inventory (EIS): No Information

Greenhouse Gas Emissions (eGGRT): No Information

Toxic Releases (TRI): No Information

Compliance and Emissions Data Reporting Interface (CEDRI): No Information

Go To Enforcement/Compliance Details

Known Data Problems <<https://epa.gov/resources/echo-data/known-data-problems>>

Facility/System Characteristics

Facility/System Characteristics

System	Statute	Identifier	Universe	Status	Areas	Permit Expiration Date	Indian Country	Latitude	Longitude
FRS		110007810495					N	18.373481	-65.900869
RCRAInfo	RCRA	PRD987369675	Other	Inactive ()			N	18.373481	-65.900869

Facility Address

System	Statute	Identifier	Facility Name	Facility Address	Facility County
FRS		110007810495	AMERICAN PROPERTIES CORP	PR-874 KM 1.1, CANOVANAS, PR 00729	Canóvanas Municipio
RCRAInfo	RCRA	PRD987369675	AMERICAN PROPERTIES CORP	STATE RD 874 KM 1.1, CANOVANAS, PR 00629	Canóvanas Municipio

Facility SIC (Standard Industrial Classification) Codes

System	Identifier	SIC Code	SIC Description
No data records returned			

Facility NAICS (North American Industry Classification System) Codes

System	Identifier	NAICS Code	NAICS Description
No data records returned			

Facility Tribe Information

Reservation Name	Tribe Name	EPA Tribal ID	Distance to Tribe (miles)
No data records returned			

Enforcement and Compliance

Compliance Monitoring History

Statute	Source ID	System	Activity Type	Compliance Monitoring Type	Lead Agency	Date	Finding (if applicable)
No data records returned							

Entries in italics are not included in ECHO's Compliance Monitoring Activity counts because they are not compliance monitoring strategy <https://www.epa.gov/compliance/compliance-monitoring-programs> activities or because they are not counted as inspections within EPA's Annual Results <https://www.epa.gov/enforcement/enforcement-data-and-results>.

Compliance Summary Data

Statute	Source ID	Current SNC (Significant Noncompliance)/HPV (High Priority Violation)	Current As Of	Qtrs with NC (Noncompliance) (of 12)	Data Last Refreshed
RCRA	PRD987369675	No	07/20/2024	0	07/19/2024

Three-Year Compliance History by Quarter

Statute	Program/Pollutant/Violation Type	QTR 1	QTR 2	QTR 3	QTR 4	QTR 5	QTR 6	QTR 7	QTR 8	QTR 9	QTR 10	QTR 11
RCRA	(Source ID: PRD987369675)	10/01-12/31/21	01/01-03/31/22	04/01-06/30/22	07/01-09/30/22	10/01-12/31/22	01/01-03/31/23	04/01-06/30/23	07/01-09/30/23	10/01-12/31/23	01/01-03/31/24	04/01-06/30/24
	Facility-Level Status	No Violation Identified	No Violation Identified	No Violation Identified	No Violation Identified	No Violation Identified	No Violation Identified	No Violation Identified	No Violation Identified	No Violation Identified	No Violation Identified	No Violation Identified
	Violation Agency											

Informal Enforcement Actions

Statute	System	Source ID	Type of Action	Lead Agency	Date
No data records returned					

Entries in italics are not counted as "informal enforcement actions" in EPA policies pertaining to enforcement response tools.

Formal Enforcement Actions

Statute	System	Law/Section	Source ID	Type of Action	Case No.	Lead Agency	Case Name	Issued/Filed Date	Settlements/Actions	Settlement/Action Date	Federal Penalty Assessed	State/Local Penalty Assessed	Penalty Amount Collected	SEP Value	Comp Action Cost
No data records returned															

Environmental Conditions

Watersheds

12-Digit WBD (Watershed Boundary Dataset) HUC (RAD (Reach Address Database))	WBD (Watershed Boundary Dataset) Subwatershed Name (RAD (Reach Address Database))	State Water Body Name (ICIS (Integrated Compliance Information System))	Beach Closures Within Last Year	Beach Closures Within Last Two Years	Pollutants Potentially Related to Impairment	Watershed with ESA (Endangered Species Act)-listed Aquatic Species?
No data records returned						

Assessed Waters From Latest State Submission (ATTAINS)

State	Report Cycle	Assessment Unit ID	Assessment Unit Name	Water Condition	Cause Groups Impaired	Drinking Water Use	Ecological Use	Fish Consumption Use	Recreation Use	Other Use
-------	--------------	--------------------	----------------------	-----------------	-----------------------	--------------------	----------------	----------------------	----------------	-----------

No data records returned

Air Quality Nonattainment Areas

Pollutant	Within Nonattainment Status Area?	Nonattainment Status Applicable Standard(s)	Within Maintenance Status Area?	Maintenance Status Applicable Standard(s)
-----------	-----------------------------------	---	---------------------------------	---

No data records returned

Pollutants

Toxics Release Inventory History of Reported Chemicals Released or Transferred in Pounds per Year at Site

TRI Facility ID	Year	Air Emissions	Surface Water Discharges	Off-Site Transfers to POTWs (Publicly Owned Treatment Works)	Underground Injections	Disposal to Land	Total On-Site Releases	Total Off-Site Transfers
-----------------	------	---------------	--------------------------	--	------------------------	------------------	------------------------	--------------------------

No data records returned

Toxics Release Inventory Total Releases and Transfers in Pounds by Chemical and Year

Chemical Name

No data records returned

Community

Environmental Justice

This section shows indexes from EJScreen, EPA's screening tool for environmental justice (EJ) concerns. EPA uses these indexes to identify geographic areas that may warrant further consideration or analysis for potential EJ concerns. Use of these indexes does not designate an area as an "EJ community" or "EJ facility." EJScreen provides screening level indicators, not a determination of the existence or absence of EJ concerns. For more information, see the EJScreen home page.

Potential Environmental Justice Concerns

- US Territory
- Supplemental/EJ index percentiles >= 90 (1-mile average)

EJScreen Indexes Shown

Index Type

Related Reports

EJScreen Community Report

Download Data

Census Block Group ID: 720291005041	US (Percentile)			State (Percentile)		
	Supplemental Indexes	Facility Census Block Group	1-mile Avg	1-mile Max	Facility Census Block Group	1-mile Avg
Count of Indexes At or Above 90th Percentile	0	3	7	0	0	4
Particulate Matter 2.5	--	N/A	--	--	N/A	--
Ozone	--	N/A	--	--	N/A	--
Diesel Particulate Matter	0	4	9	10	27	56
Air Toxics Cancer Risk	47	33	57	21	0	96
Air Toxics Respiratory Hazard Index	29	31	43	23	29	96
Toxic Releases to Air	89	97	99	42	65	99
Traffic Proximity	81	94	99	32	54	96
Lead Paint	43	52	99	20	22	94
Risk Management Plan (RMP) Facility Proximity	49	58	86	12	15	38
Hazardous Waste Proximity	71	85	99	24	43	92
Superfund Proximity	84	88	99	28	30	44
Underground Storage Tanks (UST)	76	75	99	62	61	94
Wastewater Discharge	89	92	99	36	38	75

Map Display Based on: US State

Display Map Layer

Facility 1-mile Radius Facility Census Block Group

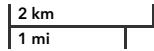

Earthstar Geographics | Esri, TomTom, Garmin, Foursquare, SafeGraph, GeoTechnologies, Inc, METI/... Powered by Esri <<http://www.esri.com/>>

Demographic Profile of Surrounding Area (1-Mile Radius)

This section provides demographic information regarding the community surrounding the facility. ECHO compliance data alone are not sufficient to determine whether violations at a particular facility had negative impacts on public health or the environment. Statistics are based upon the 2010 U.S. Census and 2017 - 2021 American Community Survey (ACS) 5-year Summary and are accurate to the extent that the facility latitude and longitude listed below are correct. Census boundaries and demographic data for U.S. Territories are based on the "2020 Island Areas Demographic Profiles" from the U.S. Census Bureau. EPA's spatial processing methodology considers the overlap between the selected radii and the census blocks (for U.S. Census demographics) and census block groups (for ACS demographics) in determining the demographics surrounding the facility. For more detail about this methodology, see the DFR Data Dictionary <<https://epa.gov/help/reports/dfr-data-dictionary#demographic>>.

General Statistics (U.S. Census)	
Total Persons	10,416
Population Density	3,420/sq.mi.
Housing Units in Area	4,104

General Statistics (ACS (American Community Survey))	
Total Persons	10,395
Percent People of Color	100%
Households in Area	3,411
Households on Public Assistance	120
Persons With Low Income	5,727
Percent With Low Income	55%

Geography	
Radius of Selected Area	1 mi.
Center Latitude	18.373481
Center Longitude	-65.900869
Land Area	99%
Water Area	1%

Income Breakdown (ACS (American Community Survey)) - Households (%)	
Less than \$15,000	610 (17.88%)
\$15,000 - \$25,000	529 (15.5%)

Age Breakdown (U.S. Census) - Persons (%)	
Children 5 years and younger	707 (7%)
Minors 17 years and younger	2,920 (28%)
Adults 18 years and older	7,496 (72%)
Seniors 65 years and older	1,218 (12%)

Race Breakdown (U.S. Census) - Persons (%)	
White	6,869 (66%)
African-American	2,067 (20%)
Hispanic-Origin	10,357 (99%)
Asian/Pacific Islander	25 (0%)
American Indian	65 (1%)
Other/Multiracial	1,390 (13%)

Education Level (Persons 25 & older) (ACS (American Community Survey)) - Persons (%)	
Less than 9th Grade	458 (6.24%)
9th through 12th Grade	334 (4.55%)
High School Diploma	1,675 (22.81%)
Some College/2-year	990 (13.48%)
B.S./B.A. (Bachelor of Science/Bachelor of Arts) or More	2,730 (37.17%)

Income Breakdown (ACS (American Community Survey)) - Households (%)	
\$25,000 - \$50,000	995 (29.16%)
\$50,000 - \$75,000	527 (15.45%)
Greater than \$75,000	751 (22.01%)



Detailed Facility Report

Facility Summary

BRISAS DE LOIZA STP

PR-874 KM 7.1, CANOVANAS, PR 00729

FRS (Facility Registry Service) ID: 110007803939

EPA Region: 02

Latitude: 18.373688

Longitude: -65.901655

Locational Data Source: RCRAINFO

Industries: Utilities

Indian Country: N

Enforcement and Compliance Summary

Statute	RCRA
Compliance Monitoring Activities (5 years)	--
Date of Last Compliance Monitoring Activity	--
Compliance Status	No Violation Identified
Qtrs in Noncompliance (of 12)	0
Qtrs with Significant Violation	0
Informal Enforcement Actions (5 years)	--
Formal Enforcement Actions (5 years)	--
Penalties from Formal Enforcement Actions (5 years)	--
EPA Cases (5 years)	--
Penalties from EPA Cases (5 years)	--

Regulatory Information

Clean Air Act (CAA): No Information

Clean Water Act (CWA): No Information

Resource Conservation and Recovery Act (RCRA): Inactive Other, (PRD000689331)

Safe Drinking Water Act (SDWA): No Information

Other Regulatory Reports

Air Emissions Inventory (EIS): No Information

Greenhouse Gas Emissions (eGGRT): No Information

Toxic Releases (TRI): No Information

Compliance and Emissions Data Reporting Interface (CEDRI): No Information

Go To Enforcement/Compliance Details

Known Data Problems <<https://epa.gov/resources/echo-data/known-data-problems>>

Facility/System Characteristics

Facility/System Characteristics

System	Statute	Identifier	Universe	Status	Areas	Permit Expiration Date	Indian Country	Latitude	Longitude
FRS		110007803939					N	18.373688	-65.901655
RCRAInfo	RCRA	PRD000689331	Other	Inactive ()			N	18.373688	-65.901655

Facility Address

System	Statute	Identifier	Facility Name	Facility Address	Facility County
FRS		110007803939	BRISAS DE LOIZA STP	PR-874 KM 7.1, CANOVANAS, PR 00729	Canóvanas Municipio
RCRAInfo	RCRA	PRD000689331	BRISAS DE LOIZA STP	STATE RD 874 KM 7.1, CANOVANAS, PR 00629	Canóvanas Municipio

Facility SIC (Standard Industrial Classification) Codes

System	Identifier	SIC Code	SIC Description
No data records returned			

Facility NAICS (North American Industry Classification System) Codes

System	Identifier	NAICS Code	NAICS Description
RCRAInfo	PRD000689331	22132	Sewage Treatment Facilities

Facility Tribe Information

Reservation Name	Tribe Name	EPA Tribal ID	Distance to Tribe (miles)
No data records returned			

Enforcement and Compliance

Compliance Monitoring History Last 5 Years

Statute	Source ID	System	Activity Type	Compliance Monitoring Type	Lead Agency	Date	Finding (if applicable)
No data records returned							

Entries in italics are not included in ECHO's Compliance Monitoring Activity counts because they are not compliance monitoring strategy <https://www.epa.gov/compliance/compliance-monitoring-programs> activities or because they are not counted as inspections within EPA's Annual Results <https://www.epa.gov/enforcement/enforcement-data-and-results>.

Compliance Summary Data

Statute	Source ID	Current SNC (Significant Noncompliance)/HPV (High Priority Violation)	Current As Of	Qtrs with NC (Noncompliance) (of 12)	Data Last Refreshed
RCRA	PRD000689331	No	07/20/2024	0	07/19/2024

Three-Year Compliance History by Quarter

Statute	Program/Pollutant/Violation Type	QTR 1	QTR 2	QTR 3	QTR 4	QTR 5	QTR 6	QTR 7	QTR 8	QTR 9	QTR 10	QTR 11
RCRA (Source ID: PRD000689331)		10/01-12/31/21	01/01-03/31/22	04/01-06/30/22	07/01-09/30/22	10/01-12/31/22	01/01-03/31/23	04/01-06/30/23	07/01-09/30/23	10/01-12/31/23	01/01-03/31/24	04/01-06/30/24
	Facility-Level Status	No Violation Identified	No Violation Identified	No Violation Identified	No Violation Identified	No Violation Identified	No Violation Identified	No Violation Identified	No Violation Identified	No Violation Identified	No Violation Identified	No Violation Identified
	Violation											
	Agency											

Informal Enforcement Actions Last 5 Years

Statute	System	Source ID	Type of Action	Lead Agency	Date
No data records returned					

Entries in italics are not counted as "informal enforcement actions" in EPA policies pertaining to enforcement response tools.

Formal Enforcement Actions Last 5 Years

Statute	System	Law/Section	Source ID	Type of Action	Case No.	Lead Agency	Case Name	Issued/ Filed Date	Settlements/ Actions	Settlement/ Action Date	Federal Penalty Assessed	State/ Local Penalty Assessed	Penalty Amount Collected	SEP Value	Comp Action Cost
No data records returned															

Environmental Conditions

Watersheds

12-Digit WBD (Watershed Boundary Dataset) HUC (RAD (Reach Address Database))	WBD (Watershed Boundary Dataset) Subwatershed Name (RAD (Reach Address Database))	State Water Body Name (ICIS (Integrated Compliance Information System))	Beach Closures Within Last Year	Beach Closures Within Last Two Years	Pollutants Potentially Related to Impairment	Watershed with ESA (Endangered Species Act)-listed Aquatic Species?
No data records returned						

Assessed Waters From Latest State Submission (ATTAINS)

State	Report Cycle	Assessment Unit ID	Assessment Unit Name	Water Condition	Cause Groups Impaired	Drinking Water Use	Ecological Use	Fish Consumption Use	Recreation Use	Other Use
-------	--------------	--------------------	----------------------	-----------------	-----------------------	--------------------	----------------	----------------------	----------------	-----------

No data records returned

Air Quality Nonattainment Areas

Pollutant	Within Nonattainment Status Area?	Nonattainment Status Applicable Standard(s)	Within Maintenance Status Area?	Maintenance Status Applicable Standard(s)
-----------	-----------------------------------	---	---------------------------------	---

No data records returned

Pollutants

Toxics Release Inventory History of Reported Chemicals Released or Transferred in Pounds per Year at Site

TRI Facility ID	Year	Air Emissions	Surface Water Discharges	Off-Site Transfers to POTWs (Publicly Owned Treatment Works)	Underground Injections	Disposal to Land	Total On-Site Releases	Total Off-Site Transfers
-----------------	------	---------------	--------------------------	--	------------------------	------------------	------------------------	--------------------------

No data records returned

Toxics Release Inventory Total Releases and Transfers in Pounds by Chemical and Year

Chemical Name

No data records returned

Community

Environmental Justice

This section shows indexes from EJScreen, EPA's screening tool for environmental justice (EJ) concerns. EPA uses these indexes to identify geographic areas that may warrant further consideration or analysis for potential EJ concerns. Use of these indexes does not designate an area as an "EJ community" or "EJ facility." EJScreen provides screening level indicators, not a determination of the existence or absence of EJ concerns. For more information, see the EJScreen home page.

Potential Environmental Justice Concerns

- US Territory
- Supplemental/EJ index percentiles >= 90 (1-mile average)

EJScreen Indexes Shown

Index Type Supplemental (default)

Related Reports

EJScreen Community Report

Download Data

Census Block Group ID: 720291005041	US (Percentile)			State (Percentile)		
	Supplemental Indexes	Facility Census Block Group	1-mile Avg	1-mile Max	Facility Census Block Group	1-mile Avg
Count of Indexes At or Above 90th Percentile	0	3	7	0	0	4
Particulate Matter 2.5	--	N/A	--	--	N/A	--
Ozone	--	N/A	--	--	N/A	--
Diesel Particulate Matter	0	4	9	10	28	56
Air Toxics Cancer Risk	47	33	57	21	0	96
Air Toxics Respiratory Hazard Index	29	31	43	23	30	96
Toxic Releases to Air	89	97	99	42	66	99
Traffic Proximity	81	94	99	32	55	96
Lead Paint	43	50	99	20	22	94
Risk Management Plan (RMP) Facility Proximity	49	59	86	12	15	38
Hazardous Waste Proximity	71	86	99	24	45	92
Superfund Proximity	84	89	99	28	30	44
Underground Storage Tanks (UST)	76	73	99	62	61	94
Wastewater Discharge	89	92	99	36	37	75

Map Display Based on: US State

Display Map Layer

Facility 1-mile Radius Facility Census Block Group

+
-

🗺

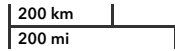

Powered by Esri <<http://www.esri.com/>>

Demographic Profile of Surrounding Area (1-Mile Radius)

This section provides demographic information regarding the community surrounding the facility. ECHO compliance data alone are not sufficient to determine whether violations at a particular facility had negative impacts on public health or the environment. Statistics are based upon the 2010 U.S. Census and 2017 - 2021 American Community Survey (ACS) 5-year Summary and are accurate to the extent that the facility latitude and longitude listed below are correct. Census boundaries and demographic data for U.S. Territories are based on the "2020 Island Areas Demographic Profiles" from the U.S. Census Bureau. EPA's spatial processing methodology considers the overlap between the selected radii and the census blocks (for U.S. Census demographics) and census block groups (for ACS demographics) in determining the demographics surrounding the facility. For more detail about this methodology, see the DFR Data Dictionary <<https://epa.gov/help/reports/dfr-data-dictionary#demographic>>.

General Statistics (U.S. Census)	
Total Persons	10,413
Population Density	3,473/sq.mi.
Housing Units in Area	4,118

General Statistics (ACS (American Community Survey))	
Total Persons	10,566
Percent People of Color	100%
Households in Area	3,471
Households on Public Assistance	121
Persons With Low Income	5,923
Percent With Low Income	56%

Geography	
Radius of Selected Area	1 mi.
Center Latitude	18.373688
Center Longitude	-65.901655
Land Area	99%
Water Area	1%

Income Breakdown (ACS (American Community Survey)) - Households (%)	
Less than \$15,000	631 (18.16%)
\$15,000 - \$25,000	549 (15.8%)

Age Breakdown (U.S. Census) - Persons (%)	
Children 5 years and younger	695 (7%)
Minors 17 years and younger	2,891 (28%)
Adults 18 years and older	7,521 (72%)
Seniors 65 years and older	1,264 (12%)

Race Breakdown (U.S. Census) - Persons (%)	
White	6,834 (66%)
African-American	2,082 (20%)
Hispanic-Origin	10,353 (99%)
Asian/Pacific Islander	27 (0%)
American Indian	65 (1%)
Other/Multiracial	1,404 (13%)

Education Level (Persons 25 & older) (ACS (American Community Survey)) - Persons (%)	
Less than 9th Grade	468 (6.25%)
9th through 12th Grade	350 (4.68%)
High School Diploma	1,748 (23.35%)
Some College/2-year	1,010 (13.49%)
B.S./B.A. (Bachelor of Science/Bachelor of Arts) or More	2,747 (36.7%)

Income Breakdown (ACS (American Community Survey)) - Households (%)	
\$25,000 - \$50,000	1,024 (29.48%)
\$50,000 - \$75,000	536 (15.43%)
Greater than \$75,000	734 (21.13%)



Detailed Facility Report

Facility Summary

ALUMINUM EXTRUSION CORP

PR-185 KM 0.65, CANOVANAS, PR 00729

FRS (Facility Registry Service) ID: 110007805688

EPA Region: 02

Latitude: 18.373702

Longitude: -65.899955

Locational Data Source: TRIS

Industries: Fabricated Metal Product Manufacturing

Indian Country: N

Enforcement and Compliance Summary

Statute	RCRA
Compliance Monitoring Activities (5 years)	--
Date of Last Compliance Monitoring Activity	01/21/2004
Compliance Status	No Violation Identified
Qtrs in Noncompliance (of 12)	0
Qtrs with Significant Violation	0
Informal Enforcement Actions (5 years)	--
Formal Enforcement Actions (5 years)	--
Penalties from Formal Enforcement Actions (5 years)	--
EPA Cases (5 years)	--
Penalties from EPA Cases (5 years)	--

Regulatory Information

Clean Air Act (CAA): No Information

Clean Water Act (CWA): No Information

Resource Conservation and Recovery Act (RCRA): Inactive Other, (PRD090000068), Inactive Other, (PRN008011124)

Safe Drinking Water Act (SDWA): No Information

Other Regulatory Reports

Air Emissions Inventory (EIS): No Information

Greenhouse Gas Emissions (eGGRT): No Information

Toxic Releases (TRI): 00629LMNMP185RO

Compliance and Emissions Data Reporting Interface (CEDRI): No Information

Go To Enforcement/Compliance Details

Known Data Problems <<https://epa.gov/resources/echo-data/known-data-problems>>

Facility/System Characteristics

Facility/System Characteristics

System	Statute	Identifier	Universe	Status	Areas	Permit Expiration Date	Indian Country	Latitude	Longitude
FRS		110007805688					N	18.373702	-65.899955
TRI	EP313	00629LMNMP185RO	Toxics Release Inventory	Last Reported for 1992			N	18.373702	-65.899955
RCRAInfo	RCRA	PRD090000068	Other	Inactive ()			N	18.373702	-65.899955
RCRAInfo	RCRA	PRN008011124	Other	Inactive ()			N	18.373702	-65.899955

Facility Address

System	Statute	Identifier	Facility Name	Facility Address	Facility County
FRS		110007805688	ALUMINUM EXTRUSSION CORP	PR-185 KM 0.65, CANOVANAS, PR 00729	Canóvanas Municipio
TRI	EP313	00629LMNMP185RO	ALUMINUM PROCESSING CORP	185 STATE RD KM 065, CANOVANAS, PR 00729	Canóvanas Municipio
RCRAInfo	RCRA	PRD090000068	ALUMINUM EXTRUSSION CORP	RD 185 KM 0.65, CANOVANAS, PR 00629	Canóvanas Municipio
RCRAInfo	RCRA	PRN008011124	PERFILES DE ALUMINIO	STATE RD 185 KM 0.65, CANOVANAS, PR 00729-1622	Canóvanas Municipio

Facility SIC (Standard Industrial Classification) Codes

System	Identifier	SIC Code	SIC Description
No data records returned			

Facility NAICS (North American Industry Classification System) Codes

System	Identifier	NAICS Code	NAICS Description
TRI	00629LMNMP185RO	332813	Electroplating, Plating, Polishing, Anodizing, and Coloring
RCRAInfo	PRD090000068	331316	Aluminum Extruded Product Manufacturing

Facility Tribe Information

Reservation Name	Tribe Name	EPA Tribal ID	Distance to Tribe (miles)
No data records returned			

Enforcement and Compliance

Compliance Monitoring History Last 5 Years

Statute	Source ID	System	Activity Type	Compliance Monitoring Type	Lead Agency	Date	Finding (if applicable)
No data records returned							

Entries in italics are not included in ECHO's Compliance Monitoring Activity counts because they are not compliance monitoring strategy
 <<https://www.epa.gov/compliance/compliance-monitoring-programs>> activities or because they are not counted as inspections within EPA's Annual Results
 <<https://www.epa.gov/enforcement/enforcement-data-and-results>>.

Compliance Summary Data

Statute	Source ID	Current SNC (Significant Noncompliance)/HPV (High Priority Violation)	Current As Of	Qtrs with NC (Noncompliance) (of 12)	Data Last Refreshed
RCRA	PRD090000068	No	07/20/2024	0	07/19/2024
RCRA	PRN008011124	No	07/20/2024	0	07/19/2024

Three-Year Compliance History by Quarter

Statute	Program/Pollutant/Violation Type	QTR 1	QTR 2	QTR 3	QTR 4	QTR 5	QTR 6	QTR 7	QTR 8	QTR 9	QTR 10	QTR 11
RCRA (Source ID: PRD090000068)		10/01-12/31/21	01/01-03/31/22	04/01-06/30/22	07/01-09/30/22	10/01-12/31/22	01/01-03/31/23	04/01-06/30/23	07/01-09/30/23	10/01-12/31/23	01/01-03/31/24	04/01-06/30/24
	Facility-Level Status	No Violation Identified	No Violation Identified	No Violation Identified	No Violation Identified	No Violation Identified	No Violation Identified	No Violation Identified	No Violation Identified	No Violation Identified	No Violation Identified	No Violation Identified
	Violation	Agency										
RCRA (Source ID: PRN008011124)		10/01-12/31/21	01/01-03/31/22	04/01-06/30/22	07/01-09/30/22	10/01-12/31/22	01/01-03/31/23	04/01-06/30/23	07/01-09/30/23	10/01-12/31/23	01/01-03/31/24	04/01-06/30/24
	Facility-Level Status	No Violation Identified	No Violation Identified	No Violation Identified	No Violation Identified	No Violation Identified	No Violation Identified	No Violation Identified	No Violation Identified	No Violation Identified	No Violation Identified	No Violation Identified
	Violation	Agency										

Informal Enforcement Actions Last 5 Years

Statute	System	Source ID	Type of Action	Lead Agency	Date
No data records returned					

Entries in italics are not counted as "informal enforcement actions" in EPA policies pertaining to enforcement response tools.

Formal Enforcement Actions Last 5 Years

Statute	System	Law/Section	Source ID	Type of Action	Case No.	Lead Agency	Case Name	Issued/ Filed Date	Settlements/ Actions	Settlement/ Action Date	Federal Penalty Assessed	State/ Local Penalty Assessed	Penalty Amount Collected	SEP Value	Comp Action Cost
No data records returned															

Environmental Conditions

Watersheds

12-Digit WBD (Watershed Boundary Dataset) HUC (Reach Address Database)	WBD (Watershed Boundary Dataset) Subwatershed Name (RAD (Reach Address Database))	State Water Body Name (ICIS (Integrated Compliance Information System))	Beach Closures Within Last Year	Beach Closures Within Last Two Years	Pollutants Potentially Related to Impairment	Watershed with ESA (Endangered Species Act)-listed Aquatic Species?
--	---	---	---------------------------------	--------------------------------------	--	---

No data records returned

Assessed Waters From Latest State Submission (ATTAINS)

State	Report Cycle	Assessment Unit ID	Assessment Unit Name	Water Condition	Cause Groups Impaired	Drinking Water Use	Ecological Use	Fish Consumption Use	Recreation Use	Other Use
-------	--------------	--------------------	----------------------	-----------------	-----------------------	--------------------	----------------	----------------------	----------------	-----------

No data records returned

Air Quality Nonattainment Areas

Pollutant	Within Nonattainment Status Area?	Nonattainment Status Applicable Standard(s)	Within Maintenance Status Area?	Maintenance Status Applicable Standard(s)
-----------	-----------------------------------	---	---------------------------------	---

No data records returned

Pollutants

Toxics Release Inventory History of Reported Chemicals Released or Transferred in Pounds per Year at Site

TRI Facility ID	Year	Air Emissions	Surface Water Discharges	Off-Site Transfers to POTWs (Publicly Owned Treatment Works)	Underground Injections	Disposal to Land	Total On-Site Releases	Total Off-Site Transfers
-----------------	------	---------------	--------------------------	--	------------------------	------------------	------------------------	--------------------------

No data records returned

Toxics Release Inventory Total Releases and Transfers in Pounds by Chemical and Year

Chemical Name

No data records returned

Community

Environmental Justice

This section shows indexes from EJScreen, EPA's screening tool for environmental justice (EJ) concerns. EPA uses these indexes to identify geographic areas that may warrant further consideration or analysis for potential EJ concerns. Use of these indexes does not designate an area as an "EJ community" or "EJ facility." EJScreen provides screening level indicators, not a determination of the existence or absence of EJ concerns. For more information, see the EJScreen home page.

Potential Environmental Justice Concerns

- US Territory
- Supplemental/EJ index percentiles >= 90 (1-mile average)

EJScreen Indexes Shown

Index Type Supplemental (default)

Related Reports

EJScreen Community Report

Download Data

Census Block Group ID: 720291005041	US (Percentile)			State (Percentile)		
	Supplemental Indexes	Facility Census Block Group	1-mile Avg	1-mile Max	Facility Census Block Group	1-mile Avg
Count of Indexes At or Above 90th Percentile	0	3	7	0	0	4
Particulate Matter 2.5	--	N/A	--	--	N/A	--
Ozone	--	N/A	--	--	N/A	--
Diesel Particulate Matter	0	4	9	10	26	56
Air Toxics Cancer Risk	47	33	57	21	0	96
Air Toxics Respiratory Hazard Index	29	31	43	23	29	96
Toxic Releases to Air	89	97	99	42	65	99
Traffic Proximity	81	94	99	32	54	96

Census Block Group ID: 720291005041	US (Percentile)			State (Percentile)		
	Facility Census Block Group	1-mile Avg	1-mile Max	Facility Census Block Group	1-mile Avg	1-mile Max
Lead Paint	43	53	99	20	22	94
Risk Management Plan (RMP) Facility Proximity	49	57	86	12	15	38
Hazardous Waste Proximity	71	85	99	24	42	92
Superfund Proximity	84	88	99	28	29	44
Underground Storage Tanks (UST)	76	76	99	62	61	94
Wastewater Discharge	89	92	99	36	38	75

Map Display Based on: US State

Display Map Layer:

Facility 1-mile Radius Facility Census Block Group

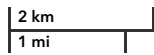
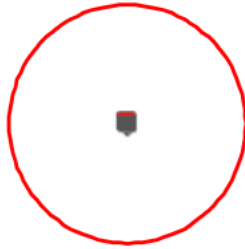

Earthstar Geographics

Powered by Esri <<http://www.esri.com/>>

Demographic Profile of Surrounding Area (1-Mile Radius)

This section provides demographic information regarding the community surrounding the facility. ECHO compliance data alone are not sufficient to determine whether violations at a particular facility had negative impacts on public health or the environment. Statistics are based upon the 2010 U.S. Census and 2017 - 2021 American Community Survey (ACS) 5-year Summary and are accurate to the extent that the facility latitude and longitude listed below are correct. Census boundaries and demographic data for U.S. Territories are based on the "2020 Island Areas Demographic Profiles" from the U.S. Census Bureau. EPA's spatial processing methodology considers the overlap between the selected radii and the census blocks (for U.S. Census demographics) and census block groups (for ACS demographics) in determining the demographics surrounding the facility. For more detail about this methodology, see the DFR Data Dictionary <<https://epa.gov/help/reports/dfr-data-dictionary#demographic>>.

General Statistics (U.S. Census)	
Total Persons	10,046
Population Density	3,216/sq.mi.
Housing Units in Area	3,950

General Statistics (ACS (American Community Survey))	
Total Persons	10,085
Percent People of Color	100%
Households in Area	3,311
Households on Public Assistance	118
Persons With Low Income	5,450
Percent With Low Income	54%

Age Breakdown (U.S. Census) - Persons (%)	
Children 5 years and younger	692 (7%)
Minors 17 years and younger	2,843 (28%)
Adults 18 years and older	7,203 (72%)
Seniors 65 years and older	1,124 (11%)

Race Breakdown (U.S. Census) - Persons (%)	
White	6,642 (66%)
African-American	2,000 (20%)
Hispanic-Origin	9,991 (99%)
Asian/Pacific Islander	23 (0%)
American Indian	62 (1%)
Other/Multiracial	1,320 (13%)

Geography	
Radius of Selected Area	1 mi.
Center Latitude	18.373702
Center Longitude	-65.899955
Land Area	99%
Water Area	1%

Income Breakdown (ACS (American Community Survey)) - Households (%)	
Less than \$15,000	589 (17.79%)
\$15,000 - \$25,000	501 (15.14%)
\$25,000 - \$50,000	947 (28.61%)
\$50,000 - \$75,000	516 (15.59%)
Greater than \$75,000	757 (22.87%)

Education Level (Persons 25 & older) (ACS (American Community Survey)) - Persons (%)	
Less than 9th Grade	444 (6.27%)
9th through 12th Grade	314 (4.44%)
High School Diploma	1,571 (22.2%)
Some College/2-year	954 (13.48%)
B.S./B.A. (Bachelor of Science/Bachelor of Arts) or More	2,675 (37.8%)



Detailed Facility Report

Facility Summary

EXTENSION CANOVANAS PLAZA RIAL II

CARR. PR-185 KM 0.07, CANOVANAS, PR 00729

FRS (Facility Registry Service) ID: 110070568020

EPA Region: 02

Latitude: 18.3731

Longitude: -65.9014

Locational Data Source: NPDES

Industries: --

Indian Country: N

Enforcement and Compliance Summary

Statute	CWA
Compliance Monitoring Activities (5 years)	--
Date of Last Compliance Monitoring Activity	--
Compliance Status	Terminated Permit
Qtrs in Noncompliance (of 12)	0
Qtrs with Significant Violation	0
Informal Enforcement Actions (5 years)	--
Formal Enforcement Actions (5 years)	--
Penalties from Formal Enforcement Actions (5 years)	--
EPA Cases (5 years)	--
Penalties from EPA Cases (5 years)	--

Regulatory Information

Clean Air Act (CAA): No Information

Clean Water Act (CWA): Non-Major, Permit Terminated; Compliance Tracking Off (PRR10008A), Non-Major, Permit Terminated; Compliance Tracking Off (PRR10008F)

Resource Conservation and Recovery Act (RCRA): No Information

Safe Drinking Water Act (SDWA): No Information

Other Regulatory Reports

Air Emissions Inventory (EIS): No Information

Greenhouse Gas Emissions (eGGRT): No Information

Toxic Releases (TRI): No Information

Compliance and Emissions Data Reporting Interface (CEDRI): No Information

Go To Enforcement/Compliance Details

Known Data Problems <<https://epa.gov/resources/echo-data/known-data-problems>>

Facility/System Characteristics

Facility/System Characteristics

System	Statute	Identifier	Universe	Status	Areas	Permit Expiration Date	Indian Country	Latitude	Longitude
FRS		110070568020					N	18.3731	-65.9014
ICIS-NPDES	CWA	PRR10008A	Non-Major: General Permit Covered Facility	Terminated; Compliance Tracking Off	Construction Stormwater	02/15/2022	N	18.3731	-65.9014
ICIS-NPDES	CWA	PRR10008F	Non-Major: General Permit Covered Facility	Terminated; Compliance Tracking Off	Construction Stormwater	02/15/2022	N	18.3731	-65.9014

Facility Address

System	Statute	Identifier	Facility Name	Facility Address	Facility County
FRS		110070568020	EXTENSION CANOVANAS PLAZA RIAL II	CARR. PR-185 KM 0.07, CANOVANAS, PR 00729	Canóvanas Municipio
ICIS-NPDES	CWA	PRR10008A	EXTENSION CANOVANAS PLAZA RIAL II	CARR. PR-185 KM 0.07, CANOVANAS, PR 00729	
ICIS-NPDES	CWA	PRR10008F	EXTENSION CANOVANAS PLAZA RIAL II	CARR. PR-185 KM 0.07, CANOVANAS, PR 00729	

Facility SIC (Standard Industrial Classification) Codes

System	Identifier	SIC Code	SIC Description
--------	------------	----------	-----------------

No data records returned

Facility NAICS (North American Industry Classification System) Codes

System	Identifier	NAICS Code	NAICS Description
--------	------------	------------	-------------------

No data records returned

Facility Industrial Effluent Guidelines

Identifier	Effluent Guideline (40 CFR Part)	Effluent Guideline Description
------------	----------------------------------	--------------------------------

No data records returned

Facility Tribe Information

Reservation Name	Tribe Name	EPA Tribal ID	Distance to Tribe (miles)
------------------	------------	---------------	---------------------------

No data records returned

Enforcement and Compliance

Compliance Monitoring History Last 5 Years

Statute	Source ID	System	Activity Type	Compliance Monitoring Type	Lead Agency	Date	Finding (if applicable)
---------	-----------	--------	---------------	----------------------------	-------------	------	-------------------------

No data records returned

Entries in italics are not included in ECHO's Compliance Monitoring Activity counts because they are not compliance monitoring strategy
 <<https://www.epa.gov/compliance/compliance-monitoring-programs>> activities or because they are not counted as inspections within EPA's Annual Results
 <<https://www.epa.gov/enforcement/enforcement-data-and-results>>.

Compliance Summary Data

Statute	Source ID	Current SNC (Significant Noncompliance)/HPV (High Priority Violation)	Current As Of	Qtrs with NC (Noncompliance) (of 12)	Data Last Refreshed
CWA	PRR10008A	No	03/31/2024	0	07/19/2024
CWA	PRR10008F	No	03/31/2024	0	07/19/2024

Three-Year Compliance History by Quarter

Statute	Program/Pollutant/Violation Type	QTR 1	QTR 2	QTR 3	QTR 4	QTR 5	QTR 6	QTR 7	QTR 8	QTR 9	QTR 10	QTR 11
CWA (Source ID: PRR10008A)		04/01-06/30/21	07/01-09/30/21	10/01-12/31/21	01/01-03/31/22	04/01-06/30/22	07/01-09/30/22	10/01-12/31/22	01/01-03/31/23	04/01-06/30/23	07/01-09/30/23	10/01-12/31/23
	Facility-Level Status	Terminated Permit	Terminated Permit	Terminated Permit	Terminated Permit	Terminated Permit	Terminated Permit	Terminated Permit	Terminated Permit	Terminated Permit	Terminated Permit	Terminated Permit
	Quarterly Noncompliance Report History											
CWA (Source ID: PRR10008F)		04/01-06/30/21	07/01-09/30/21	10/01-12/31/21	01/01-03/31/22	04/01-06/30/22	07/01-09/30/22	10/01-12/31/22	01/01-03/31/23	04/01-06/30/23	07/01-09/30/23	10/01-12/31/23
	Facility-Level Status	Terminated Permit	Terminated Permit	Terminated Permit	Terminated Permit	Terminated Permit	Terminated Permit	Terminated Permit	Terminated Permit	Terminated Permit	Terminated Permit	Terminated Permit
	Quarterly Noncompliance Report History											

Informal Enforcement Actions Last 5 Years

Statute	System	Source ID	Type of Action	Lead Agency	Date
---------	--------	-----------	----------------	-------------	------

No data records returned

Entries in italics are not counted as "informal enforcement actions" in EPA policies pertaining to enforcement response tools.

Formal Enforcement Actions Last 5 Years

Statute	System	Law/Section	Source ID	Type of Action	Case No.	Lead Agency	Case Name	Issued/Filed Date	Settlements/Actions	Settlement/Action Date	Federal Penalty Assessed	State/Local Penalty Assessed	Penalty Amount Collected	SEP Value	Comp Action Cost
---------	--------	-------------	-----------	----------------	----------	-------------	-----------	-------------------	---------------------	------------------------	--------------------------	------------------------------	--------------------------	-----------	------------------

No data records returned

Environmental Conditions

Watersheds

12-Digit WBD (Watershed Boundary Dataset) HUC (RAD (Reach Address Database))	WBD (Watershed Boundary Dataset) Subwatershed Name (RAD (Reach Address Database))	State Water Body Name (ICIS (Integrated Compliance Information System))	Beach Closures Within Last Year	Beach Closures Within Last Two Years	Pollutants Potentially Related to Impairment	Watershed with ESA (Endangered Species Act)-listed Aquatic Species?
210100050414	Rio Grande de Loiza at mouth	BOCAFORMA CREEK	No	No	--	Yes

Assessed Waters From Latest State Submission (ATTAINS)

State	Report Cycle	Assessment Unit ID	Assessment Unit Name	Water Condition	Cause Groups Impaired	Drinking Water Use	Ecological Use	Fish Consumption Use	Recreation Use	Other Use
PR	2022	PREE14A	RIO GRANDE DE LOIZA ESTUARY	Impaired - With Restoration Plan	PATHOGENS	--	Insufficient Information	--	Not Supporting	--

Air Quality Nonattainment Areas

Pollutant	Within Nonattainment Status Area?	Nonattainment Status Applicable Standard(s)	Within Maintenance Status Area?	Maintenance Status Applicable Standard(s)
-----------	-----------------------------------	---	---------------------------------	---

No data records returned

Pollutants

Toxics Release Inventory History of Reported Chemicals Released or Transferred in Pounds per Year at Site

TRI Facility ID	Year	Air Emissions	Surface Water Discharges	Off-Site Transfers to POTWs (Publicly Owned Treatment Works)	Underground Injections	Disposal to Land	Total On-Site Releases	Total Off-Site Transfers
-----------------	------	---------------	--------------------------	--	------------------------	------------------	------------------------	--------------------------

No data records returned

Toxics Release Inventory Total Releases and Transfers in Pounds by Chemical and Year

Chemical Name

No data records returned

CWA (Clean Water Act) Discharge Monitoring Report (DMR) Pollutant Loadings

DMR and TRI Multi-Year Loading Report

NPDES ID	Description
----------	-------------

No data records returned

Community

Environmental Justice

This section shows indexes from EJScreen, EPA's screening tool for environmental justice (EJ) concerns. EPA uses these indexes to identify geographic areas that may warrant further consideration or analysis for potential EJ concerns. Use of these indexes does not designate an area as an "EJ community" or "EJ facility." EJScreen provides screening level indicators, not a determination of the existence or absence of EJ concerns. For more information, see the EJScreen home page.

Potential Environmental Justice Concerns

- US Territory
- Supplemental/EJ index percentiles >= 90 (1-mile average)

EJScreen Indexes Shown

Index Type	Supplemental (default)
------------	------------------------

Related Reports

EJScreen Community Report

Download Data

Census Block Group ID: 720291005041	US (Percentile)			State (Percentile)		
	Facility Census Block Group	1-mile Avg	1-mile Max	Facility Census Block Group	1-mile Avg	1-mile Max
Supplemental Indexes						
Count of Indexes At or Above 90th Percentile	0	3	7	0	0	4
Particulate Matter 2.5	--	N/A	--	--	N/A	--

Census Block Group ID: 720291005041	US (Percentile)			State (Percentile)		
	Facility Census Block Group	1-mile Avg	1-mile Max	Facility Census Block Group	1-mile Avg	1-mile Max
Ozone	--	N/A	--	--	N/A	--
Diesel Particulate Matter	0	4	9	10	27	56
Air Toxics Cancer Risk	47	33	57	21	0	96
Air Toxics Respiratory Hazard Index	29	31	43	23	29	96
Toxic Releases to Air	89	97	99	42	65	99
Traffic Proximity	81	94	99	32	54	96
Lead Paint	43	52	99	20	22	94
Risk Management Plan (RMP) Facility Proximity	49	58	86	12	15	38
Hazardous Waste Proximity	71	85	99	24	43	92
Superfund Proximity	84	88	99	28	30	44
Underground Storage Tanks (UST)	76	74	99	62	61	94
Wastewater Discharge	89	92	99	36	37	75

Map Display Based on: US State

Display Map Layer

Facility 1-mile Radius Facility Census Block Group

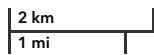

Earthstar Geographics | Esri, TomTom, Garmin, Foursquare, SafeGraph, GeoTechnologies, Inc, METI/... Powered by Esri <<http://www.esri.com/>>

Demographic Profile of Surrounding Area (1-Mile Radius)

This section provides demographic information regarding the community surrounding the facility. ECHO compliance data alone are not sufficient to determine whether violations at a particular facility had negative impacts on public health or the environment. Statistics are based upon the 2010 U.S. Census and 2017 - 2021 American Community Survey (ACS) 5-year Summary and are accurate to the extent that the facility latitude and longitude listed below are correct. Census boundaries and demographic data for U.S. Territories are based on the "2020 Island Areas Demographic Profiles" from the U.S. Census Bureau. EPA's spatial processing methodology considers the overlap between the selected radii and the census blocks (for U.S. Census demographics) and census block groups (for ACS demographics) in determining the demographics surrounding the facility. For more detail about this methodology, see the DFR Data Dictionary <<https://epa.gov/help/reports/dfr-data-dictionary#demographic>>.

General Statistics (U.S. Census)	
Total Persons	10,699
Population Density	3,404/sq.mi.
Housing Units in Area	4,226

General Statistics (ACS (American Community Survey))	
Total Persons	10,570

Age Breakdown (U.S. Census) - Persons (%)	
Children 5 years and younger	723 (7%)
Minors 17 years and younger	2,992 (28%)
Adults 18 years and older	7,707 (72%)
Seniors 65 years and older	1,269 (12%)

General Statistics (ACS (American Community Survey))	
Percent People of Color	100%
Households in Area	3,464
Households on Public Assistance	122
Persons With Low Income	5,873
Percent With Low Income	56%
Geography	
Radius of Selected Area	1 mi.
Center Latitude	18.3731
Center Longitude	-65.9014
Land Area	99%
Water Area	1%
Income Breakdown (ACS (American Community Survey)) - Households (%)	
Less than \$15,000	617 (17.82%)
\$15,000 - \$25,000	543 (15.68%)
\$25,000 - \$50,000	1,018 (29.4%)
\$50,000 - \$75,000	538 (15.54%)
Greater than \$75,000	747 (21.57%)

Race Breakdown (U.S. Census) - Persons (%)	
White	7,045 (66%)
African-American	2,123 (20%)
Hispanic-Origin	10,637 (99%)
Asian/Pacific Islander	27 (0%)
American Indian	67 (1%)
Other/Multiracial	1,437 (13%)
Education Level (Persons 25 & older) (ACS (American Community Survey)) - Persons (%)	
Less than 9th Grade	463 (6.19%)
9th through 12th Grade	342 (4.57%)
High School Diploma	1,729 (23.11%)
Some College/2-year	1,010 (13.5%)
B.S./B.A. (Bachelor of Science/Bachelor of Arts) or More	2,768 (36.99%)



Detailed Facility Report

Facility Summary

PHOTORECEPTOR SYSTEMS, INC.

CALLE 2, ESQ 3 CANOVANAS IND., CANOVANAS, PR 00729

FRS (Facility Registry Service) ID: 110006433564

EPA Region: 02

Latitude: 18.36843

Longitude: -65.90082

Locational Data Source: FRS

Industries: --

Indian Country: N

Enforcement and Compliance Summary

Statute	RCRA
Compliance Monitoring Activities (5 years)	--
Date of Last Compliance Monitoring Activity	12/01/1989
Compliance Status	No Violation Identified
Qtrs in Noncompliance (of 12)	0
Qtrs with Significant Violation	0
Informal Enforcement Actions (5 years)	--
Formal Enforcement Actions (5 years)	--
Penalties from Formal Enforcement Actions (5 years)	--
EPA Cases (5 years)	--
Penalties from EPA Cases (5 years)	--

Regulatory Information

Clean Air Act (CAA): No Information

Clean Water Act (CWA): No Information

Resource Conservation and Recovery Act (RCRA): Inactive Other, (PRD980526545)

Safe Drinking Water Act (SDWA): No Information

Other Regulatory Reports

Air Emissions Inventory (EIS): No Information

Greenhouse Gas Emissions (eGGRT): No Information

Toxic Releases (TRI): No Information

Compliance and Emissions Data Reporting Interface (CEDRI): No Information

Go To Enforcement/Compliance Details

Known Data Problems <<https://epa.gov/resources/echo-data/known-data-problems>>

Facility/System Characteristics

Facility/System Characteristics

System	Statute	Identifier	Universe	Status	Areas	Permit Expiration Date	Indian Country	Latitude	Longitude
FRS		110006433564					N	18.36843	-65.90082
ICIS		31952					N	18.376528	-65.899722
RCRAInfo	RCRA	PRD980526545	Other	Inactive ()			N		

Facility Address

System	Statute	Identifier	Facility Name	Facility Address	Facility County
FRS		110006433564	PHOTORECEPTOR SYSTEMS, INC.	CALLE 2, ESQ 3 CANOVANAS IND., CANOVANAS, PR 00729	Canóvanas Municipio
ICIS		31952	PHOTORECEPTOR SYSTEMS, INC.	CALLE 2, ESQ 3 CANOVANAS IND., CANOVANAS, PR 00729	Canóvanas Municipio
RCRAInfo	RCRA	PRD980526545	PHOTORECEPTOR SYSTEMS INC	CALLE 2 ESQ 3 CANOVANAS IND, CANOVANAS, PR 00629	Canóvanas Municipio

Facility SIC (Standard Industrial Classification) Codes

System	Identifier	SIC Code	SIC Description
No data records returned			

Facility NAICS (North American Industry Classification System) Codes

System	Identifier	NAICS Code	NAICS Description
No data records returned			

Facility Tribe Information

Reservation Name	Tribe Name	EPA Tribal ID	Distance to Tribe (miles)
No data records returned			

Enforcement and Compliance

Compliance Monitoring History

Statute	Source ID	System	Activity Type	Compliance Monitoring Type	Lead Agency	Date	Finding (if applicable)
No data records returned							

Entries in italics are not included in ECHO's Compliance Monitoring Activity counts because they are not compliance monitoring strategy <<https://www.epa.gov/compliance/compliance-monitoring-programs>> activities or because they are not counted as inspections within EPA's Annual Results <<https://www.epa.gov/enforcement/enforcement-data-and-results>>.

Compliance Summary Data

Statute	Source ID	Current SNC (Significant Noncompliance)/HPV (High Priority Violation)	Current As Of	Qtrs with NC (Noncompliance) (of 12)	Data Last Refreshed
RCRA	PRD980526545	No	07/20/2024	0	07/19/2024

Three-Year Compliance History by Quarter

Statute	Program/Pollutant/Violation Type	QTR 1	QTR 2	QTR 3	QTR 4	QTR 5	QTR 6	QTR 7	QTR 8	QTR 9	QTR 10	QTR 11
RCRA	(Source ID: PRD980526545)	10/01-12/31/21	01/01-03/31/22	04/01-06/30/22	07/01-09/30/22	10/01-12/31/22	01/01-03/31/23	04/01-06/30/23	07/01-09/30/23	10/01-12/31/23	01/01-03/31/24	04/01-06/30/24
	Facility-Level Status	No Violation Identified	No Violation Identified	No Violation Identified	No Violation Identified	No Violation Identified	No Violation Identified	No Violation Identified	No Violation Identified	No Violation Identified	No Violation Identified	No Violation Identified
	Violation Agency											

Informal Enforcement Actions

Statute	System	Source ID	Type of Action	Lead Agency	Date
No data records returned					

Entries in italics are not counted as "informal enforcement actions" in EPA policies pertaining to enforcement response tools.

Formal Enforcement Actions

Statute	System	Law/Section	Source ID	Type of Action	Case No.	Lead Agency	Case Name	Issued/Filed Date	Settlements/Actions	Settlement/Action Date	Federal Penalty Assessed	State/Local Penalty Assessed	Penalty Amount Collected	SEP Value	Comp Action Cost
No data records returned															

Environmental Conditions

Watersheds

12-Digit WBD (Watershed Boundary Dataset) HUC (RAD (Reach Address Database))	WBD (Watershed Boundary Dataset) Subwatershed Name (RAD (Reach Address Database))	State Water Body Name (ICIS (Integrated Compliance Information System))	Beach Closures Within Last Year	Beach Closures Within Last Two Years	Pollutants Potentially Related to Impairment	Watershed with ESA (Endangered Species Act)-listed Aquatic Species?
No data records returned						

Assessed Waters From Latest State Submission (ATTAINS)

State	Report Cycle	Assessment Unit ID	Assessment Unit Name	Water Condition	Cause Groups Impaired	Drinking Water Use	Ecological Use	Fish Consumption Use	Recreation Use	Other Use
-------	--------------	--------------------	----------------------	-----------------	-----------------------	--------------------	----------------	----------------------	----------------	-----------

No data records returned

Air Quality Nonattainment Areas

Pollutant	Within Nonattainment Status Area?	Nonattainment Status Applicable Standard(s)	Within Maintenance Status Area?	Maintenance Status Applicable Standard(s)
-----------	-----------------------------------	---	---------------------------------	---

No data records returned

Pollutants

Toxics Release Inventory History of Reported Chemicals Released or Transferred in Pounds per Year at Site

TRI Facility ID	Year	Air Emissions	Surface Water Discharges	Off-Site Transfers to POTWs (Publicly Owned Treatment Works)	Underground Injections	Disposal to Land	Total On-Site Releases	Total Off-Site Transfers
-----------------	------	---------------	--------------------------	--	------------------------	------------------	------------------------	--------------------------

No data records returned

Toxics Release Inventory Total Releases and Transfers in Pounds by Chemical and Year

Chemical Name

No data records returned

Community

Environmental Justice

This section shows indexes from EJScreen, EPA's screening tool for environmental justice (EJ) concerns. EPA uses these indexes to identify geographic areas that may warrant further consideration or analysis for potential EJ concerns. Use of these indexes does not designate an area as an "EJ community" or "EJ facility." EJScreen provides screening level indicators, not a determination of the existence or absence of EJ concerns. For more information, see the EJScreen home page.

Potential Environmental Justice Concerns

- US Territory
- Supplemental/EJ index percentiles >= 90 (Census block group)
- Supplemental/EJ index percentiles >= 90 (1-mile average)

EJScreen Indexes Shown

Index Type

Related Reports

EJScreen Community Report

Download Data

Census Block Group ID: 720291005031	US (Percentile)			State (Percentile)		
	Supplemental Indexes	Facility Census Block Group	1-mile Avg	1-mile Max	Facility Census Block Group	1-mile Avg
Count of Indexes At or Above 90th Percentile	3	3	7	0	0	4
Particulate Matter 2.5	--	N/A	--	--	N/A	--
Ozone	--	N/A	--	--	N/A	--
Diesel Particulate Matter	3	4	9	19	25	56
Air Toxics Cancer Risk	49	33	57	23	0	96
Air Toxics Respiratory Hazard Index	30	30	43	25	28	96
Toxic Releases to Air	95	96	99	61	63	99
Traffic Proximity	92	93	99	48	52	96
Lead Paint	0	53	99	0	22	94
Risk Management Plan (RMP) Facility Proximity	51	57	82	13	15	31
Hazardous Waste Proximity	82	84	97	37	41	82
Superfund Proximity	86	88	99	28	29	44
Underground Storage Tanks (UST)	87	75	99	63	61	94
Wastewater Discharge	93	92	99	41	37	70

Map Display Based on: US State

Display Map Layer

Facility 1-mile Radius Facility Census Block Group

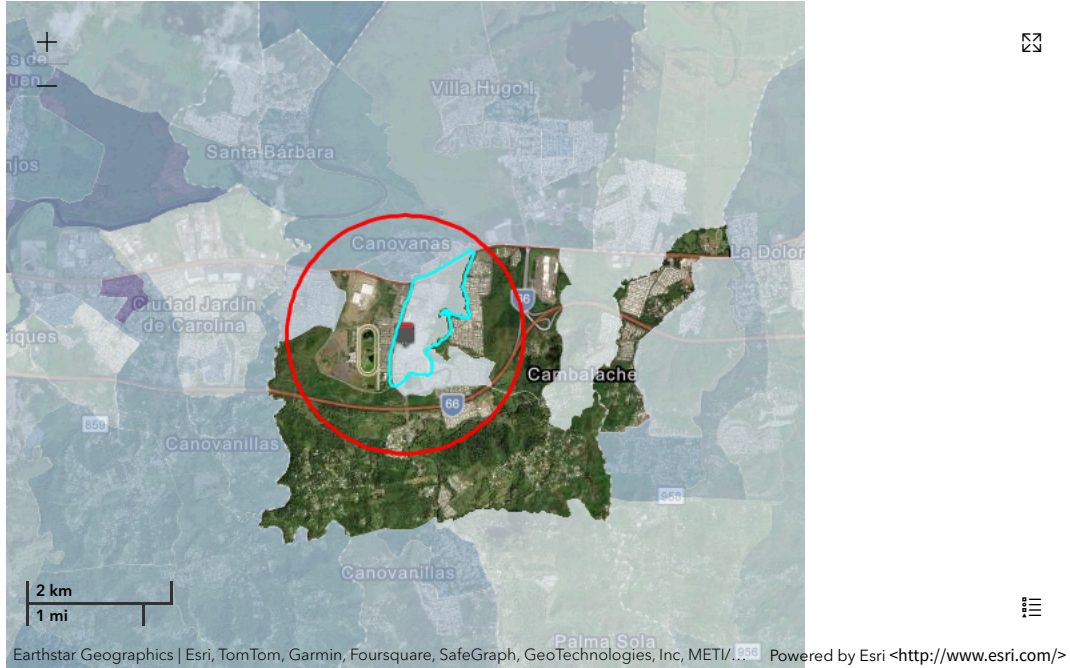

Demographic Profile of Surrounding Area (1-Mile Radius)

This section provides demographic information regarding the community surrounding the facility. ECHO compliance data alone are not sufficient to determine whether violations at a particular facility had negative impacts on public health or the environment. Statistics are based upon the 2010 U.S. Census and 2017 - 2021 American Community Survey (ACS) 5-year Summary and are accurate to the extent that the facility latitude and longitude listed below are correct. Census boundaries and demographic data for U.S. Territories are based on the "2020 Island Areas Demographic Profiles" from the U.S. Census Bureau. EPA's spatial processing methodology considers the overlap between the selected radii and the census blocks (for U.S. Census demographics) and census block groups (for ACS demographics) in determining the demographics surrounding the facility. For more detail about this methodology, see the DFR Data Dictionary <<https://epa.gov/help/reports/dfr-data-dictionary#demographic>>.

General Statistics (U.S. Census)	
Total Persons	10,613
Population Density	3,364/sq.mi.
Housing Units in Area	4,234

General Statistics (ACS (American Community Survey))	
Total Persons	10,295
Percent People of Color	100%
Households in Area	3,346
Households on Public Assistance	113
Persons With Low Income	5,417
Percent With Low Income	53%

Geography	
Radius of Selected Area	1 mi.
Center Latitude	18.36843
Center Longitude	-65.90082
Land Area	99%
Water Area	1%

Income Breakdown (ACS (American Community Survey)) - Households (%)	
Less than \$15,000	528 (15.78%)
\$15,000 - \$25,000	496 (14.82%)

Age Breakdown (U.S. Census) - Persons (%)	
Children 5 years and younger	728 (7%)
Minors 17 years and younger	2,997 (28%)
Adults 18 years and older	7,616 (72%)
Seniors 65 years and older	1,177 (11%)

Race Breakdown (U.S. Census) - Persons (%)	
White	7,010 (66%)
African-American	2,104 (20%)
Hispanic-Origin	10,552 (99%)
Asian/Pacific Islander	25 (0%)
American Indian	65 (1%)
Other/Multiracial	1,409 (13%)

Education Level (Persons 25 & older) (ACS (American Community Survey)) - Persons (%)	
Less than 9th Grade	412 (5.68%)
9th through 12th Grade	286 (3.94%)
High School Diploma	1,602 (22.07%)
Some College/2-year	994 (13.7%)
B.S./B.A. (Bachelor of Science/Bachelor of Arts) or More	2,803 (38.62%)

Income Breakdown (ACS (American Community Survey)) - Households (%)	
\$25,000 - \$50,000	970 (28.98%)
\$50,000 - \$75,000	552 (16.49%)
Greater than \$75,000	801 (23.93%)



Detailed Facility Report

Facility Summary

AGOSTO TIRE CENTER & SERVICE STATION

RD 3 KM 16.1, CANOVANAS, PR 00729

FRS (Facility Registry Service) ID: 110007814749

EPA Region: 02

Latitude: 18.37652

Longitude: -65.913955

Locational Data Source: RCRAINFO

Industries: --

Indian Country: N

Enforcement and Compliance Summary

Statute	RCRA
Compliance Monitoring Activities (5 years)	--
Date of Last Compliance Monitoring Activity	10/21/1996
Compliance Status	No Violation Identified
Qtrs in Noncompliance (of 12)	0
Qtrs with Significant Violation	0
Informal Enforcement Actions (5 years)	--
Formal Enforcement Actions (5 years)	--
Penalties from Formal Enforcement Actions (5 years)	--
EPA Cases (5 years)	--
Penalties from EPA Cases (5 years)	--

Regulatory Information

Clean Air Act (CAA): No Information

Clean Water Act (CWA): No Information

Resource Conservation and Recovery Act (RCRA): Inactive Other, (PRO007001597)

Safe Drinking Water Act (SDWA): No Information

Other Regulatory Reports

Air Emissions Inventory (EIS): No Information

Greenhouse Gas Emissions (eGGRT): No Information

Toxic Releases (TRI): No Information

Compliance and Emissions Data Reporting Interface (CEDRI): No Information

Go To Enforcement/Compliance Details

Known Data Problems <<https://epa.gov/resources/echo-data/known-data-problems>>

Facility/System Characteristics

Facility/System Characteristics

System	Statute	Identifier	Universe	Status	Areas	Permit Expiration Date	Indian Country	Latitude	Longitude
FRS		110007814749					N	18.37652	-65.913955
RCRAInfo	RCRA	PRO007001597	Other	Inactive ()			N		

Facility Address

System	Statute	Identifier	Facility Name	Facility Address	Facility County
FRS		110007814749	AGOSTO TIRE CENTER & SERVICE STATION	RD 3 KM 16.1, CANOVANAS, PR 00729	Canóvanas Municipio
RCRAInfo	RCRA	PRO007001597	AGOSTO TIRE CENTER & SERVICE STATION	RD 3 KM 16.1, CANOVANAS, PR 00729	Canóvanas Municipio

Facility SIC (Standard Industrial Classification) Codes

System	Identifier	SIC Code	SIC Description
No data records returned			

Facility NAICS (North American Industry Classification System) Codes

System	Identifier	NAICS Code	NAICS Description
No data records returned			

Facility Tribe Information

Reservation Name	Tribe Name	EPA Tribal ID	Distance to Tribe (miles)
No data records returned			

Enforcement and Compliance

Compliance Monitoring History Last 5 Years

Statute	Source ID	System	Activity Type	Compliance Monitoring Type	Lead Agency	Date	Finding (if applicable)
No data records returned							

Entries in italics are not included in ECHO's Compliance Monitoring Activity counts because they are not compliance monitoring strategy <https://www.epa.gov/compliance/compliance-monitoring-programs> activities or because they are not counted as inspections within EPA's Annual Results <https://www.epa.gov/enforcement/enforcement-data-and-results>.

Compliance Summary Data

Statute	Source ID	Current SNC (Significant Noncompliance)/HPV (High Priority Violation)	Current As Of	Qtrs with NC (Noncompliance) (of 12)	Data Last Refreshed
RCRA	PRO007001597	No	07/20/2024	0	07/19/2024

Three-Year Compliance History by Quarter

Statute	Program/Pollutant/Violation Type	QTR 1	QTR 2	QTR 3	QTR 4	QTR 5	QTR 6	QTR 7	QTR 8	QTR 9	QTR 10	QTR 11
RCRA	(Source ID: PRO007001597)	10/01-12/31/21	01/01-03/31/22	04/01-06/30/22	07/01-09/30/22	10/01-12/31/22	01/01-03/31/23	04/01-06/30/23	07/01-09/30/23	10/01-12/31/23	01/01-03/31/24	04/01-06/30/24
	Facility-Level Status	No Violation Identified	No Violation Identified	No Violation Identified	No Violation Identified	No Violation Identified	No Violation Identified	No Violation Identified	No Violation Identified	No Violation Identified	No Violation Identified	No Violation Identified
	Violation Agency											

Informal Enforcement Actions Last 5 Years

Statute	System	Source ID	Type of Action	Lead Agency	Date
No data records returned					

Entries in italics are not counted as "informal enforcement actions" in EPA policies pertaining to enforcement response tools.

Formal Enforcement Actions Last 5 Years

Statute	System	Law/Section	Source ID	Type of Action	Case No.	Lead Agency	Case Name	Issued/Filed Date	Settlements/Actions	Settlement/Action Date	Federal Penalty Assessed	State/Local Penalty Assessed	Penalty Amount Collected	SEP Value	Comp Action Cost
No data records returned															

Environmental Conditions

Watersheds

12-Digit WBD (Watershed Boundary Dataset) HUC (RAD (Reach Address Database))	WBD (Watershed Boundary Dataset) Subwatershed Name (RAD (Reach Address Database))	State Water Body Name (ICIS (Integrated Compliance Information System))	Beach Closures Within Last Year	Beach Closures Within Last Two Years	Pollutants Potentially Related to Impairment	Watershed with ESA (Endangered Species Act)-listed Aquatic Species?
No data records returned						

Assessed Waters From Latest State Submission (ATTAINS)

State	Report Cycle	Assessment Unit ID	Assessment Unit Name	Water Condition	Cause Groups Impaired	Drinking Water Use	Ecological Use	Fish Consumption Use	Recreation Use	Other Use
-------	--------------	--------------------	----------------------	-----------------	-----------------------	--------------------	----------------	----------------------	----------------	-----------

No data records returned

Air Quality Nonattainment Areas

Pollutant	Within Nonattainment Status Area?	Nonattainment Status Applicable Standard(s)	Within Maintenance Status Area?	Maintenance Status Applicable Standard(s)
-----------	-----------------------------------	---	---------------------------------	---

No data records returned

Pollutants

Toxics Release Inventory History of Reported Chemicals Released or Transferred in Pounds per Year at Site

TRI Facility ID	Year	Air Emissions	Surface Water Discharges	Off-Site Transfers to POTWs (Publicly Owned Treatment Works)	Underground Injections	Disposal to Land	Total On-Site Releases	Total Off-Site Transfers
-----------------	------	---------------	--------------------------	--	------------------------	------------------	------------------------	--------------------------

No data records returned

Toxics Release Inventory Total Releases and Transfers in Pounds by Chemical and Year

Chemical Name

No data records returned

Community

Environmental Justice

This section shows indexes from EJScreen, EPA's screening tool for environmental justice (EJ) concerns. EPA uses these indexes to identify geographic areas that may warrant further consideration or analysis for potential EJ concerns. Use of these indexes does not designate an area as an "EJ community" or "EJ facility." EJScreen provides screening level indicators, not a determination of the existence or absence of EJ concerns. For more information, see the EJScreen home page.

Potential Environmental Justice Concerns

- US Territory
- Supplemental/EJ index percentiles >= 90 (Census block group)
- Supplemental/EJ index percentiles >= 90 (1-mile average)

EJScreen Indexes Shown

Index Type

Related Reports

EJScreen Community Report

Download Data

Census Block Group ID: 720291002001	US (Percentile)			State (Percentile)		
	Supplemental Indexes	Facility Census Block Group	1-mile Avg	1-mile Max	Facility Census Block Group	1-mile Avg
Count of indexes At or Above 90th Percentile	7	5	7	0	0	4
Particulate Matter 2.5	--	N/A	--	--	N/A	--
Ozone	--	N/A	--	--	N/A	--
Diesel Particulate Matter	4	6	20	40	37	67
Air Toxics Cancer Risk	52	34	56	49	0	94
Air Toxics Respiratory Hazard Index	34	32	41	50	38	93
Toxic Releases to Air	99	98	99	83	70	97
Traffic Proximity	99	97	99	78	63	96
Lead Paint	97	62	99	77	25	94
Risk Management Plan (RMP) Facility Proximity	68	69	88	20	22	43
Hazardous Waste Proximity	93	93	99	59	64	92
Superfund Proximity	94	92	98	36	34	44
Underground Storage Tanks (UST)	92	45	99	72	0	92
Wastewater Discharge	98	91	99	59	31	89

Map Display Based on: US State

Display Map Layer

Facility 1-mile Radius Facility Census Block Group

+
—

🗺

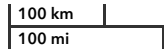

Earthstar Geographics

Powered by Esri <<http://www.esri.com/>>

Demographic Profile of Surrounding Area (1-Mile Radius)

This section provides demographic information regarding the community surrounding the facility. ECHO compliance data alone are not sufficient to determine whether violations at a particular facility had negative impacts on public health or the environment. Statistics are based upon the 2010 U.S. Census and 2017 - 2021 American Community Survey (ACS) 5-year Summary and are accurate to the extent that the facility latitude and longitude listed below are correct. Census boundaries and demographic data for U.S. Territories are based on the "2020 Island Areas Demographic Profiles" from the U.S. Census Bureau. EPA's spatial processing methodology considers the overlap between the selected radii and the census blocks (for U.S. Census demographics) and census block groups (for ACS demographics) in determining the demographics surrounding the facility. For more detail about this methodology, see the DFR Data Dictionary <<https://epa.gov/help/reports/dfr-data-dictionary#demographic>>.

General Statistics (U.S. Census)	
Total Persons	9,058
Population Density	3,012/sq.mi.
Housing Units in Area	3,750

General Statistics (ACS (American Community Survey))	
Total Persons	9,726
Percent People of Color	100%
Households in Area	3,347
Households on Public Assistance	140
Persons With Low Income	5,780
Percent With Low Income	60%

Geography	
Radius of Selected Area	1 mi.
Center Latitude	18.37652
Center Longitude	-65.913955
Land Area	97%
Water Area	3%

Income Breakdown (ACS (American Community Survey)) - Households (%)	
Less than \$15,000	722 (21.57%)
\$15,000 - \$25,000	557 (16.64%)

Age Breakdown (U.S. Census) - Persons (%)	
Children 5 years and younger	505 (6%)
Minors 17 years and younger	2,191 (24%)
Adults 18 years and older	6,867 (76%)
Seniors 65 years and older	1,373 (15%)

Race Breakdown (U.S. Census) - Persons (%)	
White	5,917 (65%)
African-American	1,959 (22%)
Hispanic-Origin	8,972 (99%)
Asian/Pacific Islander	23 (0%)
American Indian	50 (1%)
Other/Multiracial	1,108 (12%)

Education Level (Persons 25 & older) (ACS (American Community Survey)) - Persons (%)	
Less than 9th Grade	427 (6.06%)
9th through 12th Grade	387 (5.49%)
High School Diploma	1,937 (27.49%)
Some College/2-year	867 (12.31%)
B.S./B.A. (Bachelor of Science/Bachelor of Arts) or More	2,527 (35.87%)

Income Breakdown (ACS (American Community Survey)) - Households (%)	
\$25,000 - \$50,000	904 (27%)
\$50,000 - \$75,000	556 (16.61%)
Greater than \$75,000	609 (18.19%)



Detailed Facility Report

Facility Summary

HIPODROMO CAMARERO

STATE RD 3 KM 15.3, CANOVANAS, PR 00729

FRS (Facility Registry Service) ID: 110032966645

EPA Region: 02

Latitude: 18.376349

Longitude: -65.910913

Locational Data Source: RCRAINFO

Industries: Performing Arts, Spectator Sports, and Related Industries

Indian Country: N

Enforcement and Compliance Summary

Statute	RCRA
Compliance Monitoring Activities (5 years)	--
Date of Last Compliance Monitoring Activity	11/14/2007
Compliance Status	No Violation Identified
Qtrs in Noncompliance (of 12)	0
Qtrs with Significant Violation	0
Informal Enforcement Actions (5 years)	--
Formal Enforcement Actions (5 years)	--
Penalties from Formal Enforcement Actions (5 years)	--
EPA Cases (5 years)	--
Penalties from EPA Cases (5 years)	--

Regulatory Information

Clean Air Act (CAA): No Information

Clean Water Act (CWA): No Information

Resource Conservation and Recovery Act (RCRA): Active SQG, (PRR000021196)

Safe Drinking Water Act (SDWA): No Information

Other Regulatory Reports

Air Emissions Inventory (EIS): No Information

Greenhouse Gas Emissions (eGGRT): No Information

Toxic Releases (TRI): No Information

Compliance and Emissions Data Reporting Interface (CEDRI): No Information

Go To Enforcement/Compliance Details

Known Data Problems <<https://epa.gov/resources/echo-data/known-data-problems>>

Facility/System Characteristics

Facility/System Characteristics

System	Statute	Identifier	Universe	Status	Areas	Permit Expiration Date	Indian Country	Latitude	Longitude
FRS		110032966645					N	18.376349	-65.910913
RCRAInfo	RCRA	PRR000021196	SQG	Active (H)			N	18.376349	-65.910913

Facility Address

System	Statute	Identifier	Facility Name	Facility Address	Facility County
FRS		110032966645	HIPODROMO CAMARERO	STATE RD 3 KM 15.3, CANOVANAS, PR 00729	Canóvanas Municipio

System	Statute	Identifier	Facility Name	Facility Address	Facility County
RCRAInfo	RCRA	PRR000021196	HIPODROMO CAMARERO	STATE RD 3 KM 15.3, CANOVANAS, PR 00729	Canóvanas Municipio

Facility SIC (Standard Industrial Classification) Codes

System	Identifier	SIC Code	SIC Description
No data records returned			

Facility NAICS (North American Industry Classification System) Codes

System	Identifier	NAICS Code	NAICS Description
RCRAInfo	PRR000021196	711212	Racetracks

Facility Tribe Information

Reservation Name	Tribe Name	EPA Tribal ID	Distance to Tribe (miles)
No data records returned			

Enforcement and Compliance

Compliance Monitoring History

Statute	Source ID	System	Activity Type	Compliance Monitoring Type	Lead Agency	Date	Finding (if applicable)
No data records returned							

Entries in italics are not included in ECHO's Compliance Monitoring Activity counts because they are not compliance monitoring strategy <<https://www.epa.gov/compliance/compliance-monitoring-programs>> activities or because they are not counted as inspections within EPA's Annual Results <<https://www.epa.gov/enforcement/enforcement-data-and-results>>.

Compliance Summary Data

Statute	Source ID	Current SNC (Significant Noncompliance)/HPV (High Priority Violation)	Current As Of	Qtrs with NC (Noncompliance) (of 12)	Data Last Refreshed
RCRA	PRR000021196	No	07/20/2024	0	07/19/2024

Three-Year Compliance History by Quarter

Statute	Program/Pollutant/Violation Type	QTR 1	QTR 2	QTR 3	QTR 4	QTR 5	QTR 6	QTR 7	QTR 8	QTR 9	QTR 10	QTR 11
RCRA (Source ID: PRR000021196)		10/01-12/31/21	01/01-03/31/22	04/01-06/30/22	07/01-09/30/22	10/01-12/31/22	01/01-03/31/23	04/01-06/30/23	07/01-09/30/23	10/01-12/31/23	01/01-03/31/24	04/01-06/30/24
	Facility-Level Status	No Violation Identified	No Violation Identified	No Violation Identified	No Violation Identified	No Violation Identified	No Violation Identified	No Violation Identified	No Violation Identified	No Violation Identified	No Violation Identified	No Violation Identified
	Violation											
	Agency											

Informal Enforcement Actions

Statute	System	Source ID	Type of Action	Lead Agency	Date
No data records returned					

Entries in italics are not counted as "informal enforcement actions" in EPA policies pertaining to enforcement response tools.

Formal Enforcement Actions

Statute	System	Law/Section	Source ID	Type of Action	Case No.	Lead Agency	Case Name	Issued/ Filed Date	Settlements/ Actions	Settlement/ Action Date	Federal Penalty Assessed	State/ Local Penalty Assessed	Penalty Amount Collected	SEP Value	Comp Action Cost
No data records returned															

Environmental Conditions

Watersheds

12-Digit WBD (Watershed Boundary Dataset) HUC (RAD (Reach Address Database))	WBD (Watershed Boundary Dataset) Subwatershed Name (RAD (Reach Address Database))	State Water Body Name (ICIS (Integrated Compliance Information System))	Beach Closures Within Last Year	Beach Closures Within Last Two Years	Pollutants Potentially Related to Impairment	Watershed with ESA (Endangered Species Act)-listed Aquatic Species?
No data records returned						

Assessed Waters From Latest State Submission (ATTAINS)

State	Report Cycle	Assessment Unit ID	Assessment Unit Name	Water Condition	Cause Groups Impaired	Drinking Water Use	Ecological Use	Fish Consumption Use	Recreation Use	Other Use
No data records returned										

Air Quality Nonattainment Areas

Pollutant	Within Nonattainment Status Area?	Nonattainment Status Applicable Standard(s)	Within Maintenance Status Area?	Maintenance Status Applicable Standard(s)
-----------	-----------------------------------	---	---------------------------------	---

No data records returned

Pollutants

Toxics Release Inventory History of Reported Chemicals Released or Transferred in Pounds per Year at Site

TRI Facility ID	Year	Air Emissions	Surface Water Discharges	Off-Site Transfers to POTWs (Publicly Owned Treatment Works)	Underground Injections	Disposal to Land	Total On-Site Releases	Total Off-Site Transfers
-----------------	------	---------------	--------------------------	--	------------------------	------------------	------------------------	--------------------------

No data records returned

Toxics Release Inventory Total Releases and Transfers in Pounds by Chemical and Year

Chemical Name

No data records returned

e-Manifest Hazardous Waste History (Public)

Hazardous Waste Shipped in Kilograms by Year (Through 4/20/2024)

Source ID	Waste Description	2021	2022	2023	2024
PRR000021196	Hazardous Waste	731	1,052	1,184	144
PRR000021196	Acute Hazardous Waste	0	0	0	0
PRR000021196	Pharmaceutical Hazardous Waste	0	0	0	0

"Pharmaceutical Hazardous Waste" refers to quantities managed under 40 CFR part 266 subpart P and thus excluded from the Hazardous and Acute Hazardous Waste quantities shown above.

Community

Environmental Justice

This section shows indexes from EJScreen, EPA's screening tool for environmental justice (EJ) concerns. EPA uses these indexes to identify geographic areas that may warrant further consideration or analysis for potential EJ concerns. Use of these indexes does not designate an area as an "EJ community" or "EJ facility." EJScreen provides screening level indicators, not a determination of the existence or absence of EJ concerns. For more information, see the EJScreen home page.

Potential Environmental Justice Concerns

- US Territory
- Supplemental/EJ index percentiles >= 90 (Census block group)
- Supplemental/EJ index percentiles >= 90 (1-mile average)

EJScreen Indexes Shown

Index Type Supplemental (default)

Related Reports

EJScreen Community Report

Download Data

Census Block Group ID: 720291002001	US (Percentile)			State (Percentile)		
	Facility Census Block Group	1-mile Avg	1-mile Max	Facility Census Block Group	1-mile Avg	1-mile Max
Count of Indexes At or Above 90th Percentile	7	5	7	0	0	4
Particulate Matter 2.5	--	N/A	--	--	N/A	--
Ozone	--	N/A	--	--	N/A	--
Diesel Particulate Matter	4	5	9	40	35	56
Air Toxics Cancer Risk	52	34	57	49	0	96
Air Toxics Respiratory Hazard Index	34	32	43	50	37	96
Toxic Releases to Air	99	98	99	83	71	99
Traffic Proximity	99	97	99	78	65	96

Census Block Group ID: 720291002001	US (Percentile)			State (Percentile)		
	Facility Census Block Group	1-mile Avg	1-mile Max	Facility Census Block Group	1-mile Avg	1-mile Max
Lead Paint	97	65	99	77	27	94
Risk Management Plan (RMP) Facility Proximity	68	67	86	20	20	40
Hazardous Waste Proximity	93	92	99	59	60	92
Superfund Proximity	94	92	99	36	34	44
Underground Storage Tanks (UST)	92	64	99	72	0	94
Wastewater Discharge	98	93	99	59	36	89

Map Display Based on: US State

Display Map Layer

Facility 1-mile Radius Facility Census Block Group



Powered by Esri <<http://www.esri.com/>>

Demographic Profile of Surrounding Area (1-Mile Radius)

This section provides demographic information regarding the community surrounding the facility. ECHO compliance data alone are not sufficient to determine whether violations at a particular facility had negative impacts on public health or the environment. Statistics are based upon the 2010 U.S. Census and 2017 - 2021 American Community Survey (ACS) 5-year Summary and are accurate to the extent that the facility latitude and longitude listed below are correct. Census boundaries and demographic data for U.S. Territories are based on the "2020 Island Areas Demographic Profiles" from the U.S. Census Bureau. EPA's spatial processing methodology considers the overlap between the selected radii and the census blocks (for U.S. Census demographics) and census block groups (for ACS demographics) in determining the demographics surrounding the facility. For more detail about this methodology, see the DFR Data Dictionary <<https://epa.gov/help/reports/dfr-data-dictionary#demographic>>.

General Statistics (U.S. Census)	
Total Persons	8,903
Population Density	2,941/sq.mi.
Housing Units in Area	3,734

General Statistics (ACS (American Community Survey))	
Total Persons	9,873
Percent People of Color	100%
Households in Area	3,364
Households on Public Assistance	146
Persons With Low Income	5,887
Percent With Low Income	60%

Age Breakdown (U.S. Census) - Persons (%)	
Children 5 years and younger	520 (6%)
Minors 17 years and younger	2,188 (25%)
Adults 18 years and older	6,715 (75%)
Seniors 65 years and older	1,361 (15%)

Race Breakdown (U.S. Census) - Persons (%)	
White	5,707 (64%)
African-American	1,946 (22%)
Hispanic-Origin	8,841 (99%)
Asian/Pacific Islander	20 (0%)
American Indian	56 (1%)
Other/Multiracial	1,174 (13%)

Geography	
Radius of Selected Area	1 mi.
Center Latitude	18.376349
Center Longitude	-65.910913
Land Area	97%
Water Area	3%

Education Level (Persons 25 & older) (ACS (American Community Survey)) - Persons (%)	
Less than 9th Grade	456 (6.4%)
9th through 12th Grade	382 (5.37%)
High School Diploma	1,891 (26.56%)
Some College/2-year	903 (12.68%)
B.S./B.A. (Bachelor of Science/Bachelor of Arts) or More	2,506 (35.2%)

Income Breakdown (ACS (American Community Survey)) - Households (%)	
Less than \$15,000	713 (21.2%)
\$15,000 - \$25,000	553 (16.44%)
\$25,000 - \$50,000	930 (27.65%)
\$50,000 - \$75,000	551 (16.38%)
Greater than \$75,000	616 (18.32%)



Memorandum to File

Date: 10/08/2024

From: 
Hector L. Sanchez Cruz, PE
SCA Consulting Engineering LLC
CDBG-MIT Program
Economic Development Investment Portfolio for Growth- Lifeline Mitigation
Program
Puerto Rico Department of Housing

Application Number: IPGM-00375

Project: Econo Energy Project

Re: Justification for the Infeasibility and Impracticability of Radon Testing

After reviewing Application Number IPGM-00375 under the Economic Development Investment Portfolio for Growth- Lifeline Mitigation Program, administered by the Puerto Rico Department of Housing (**PRDOH**), to complete the property's contamination analysis in accordance with 24 C.F.R. § 50.3(i) and 24 C.F.R. § 58.5(i), we have determined that testing the property's radon levels is infeasible and impracticable.

Per the U.S. Department of Housing and Urban Development's (**HUD**) CPD Notice 23-103, the recommended best practices and alternative options for radon testing are infeasible and impracticable in this case due to the following reasons:

- As required by the CPD Notice 23-103, the scientific data reviewed in lieu of testing must consist of a minimum of ten documented test results over the previous ten years. If there are less than ten documented results over this period, it is understood that there is a lack of scientific data. The latest report for radon testing in Puerto Rico was prepared in 1995 by the U.S. Department of the Interior in Cooperation with the U.S. Environmental Protection Agency. No other completed studies and reports on radon testing are available in Puerto Rico.
- There is no available science-based or state-generated information for Puerto Rico for the last ten years that can be used to determine whether the project site is in a high-risk area. The Department of Health and Human Services, Centers for Disease Control and Prevention (**CDC**), National Environmental Public Health Tracking, and Radon Testing map do not include Puerto Rico data.

- There are only two (2) licensed professionals in Puerto Rico who can conduct radon testing using the American National Standards Institute/American Association of Radon Scientists and Technologists (**ANSI/AARST**) testing standards, which makes it difficult, time-consuming, and highly expensive to coordinate and secure a site visit for the contamination evaluation.
- Do-it-yourself (**DIY**) radon test kits are known to be unreliable in assuring and controlling the quality of the test results; they are not readily available in Puerto Rico, and the cost and time required for purchasing and sending them for analysis are unreasonable when weighed against the results' reliability and the need for prompt results.
- Local authorities in Puerto Rico do not have the specialized radon monitoring equipment or trained staff needed to conduct the radon testing analysis and ensure proper quality control and quality assurance practices are adhered to. We also do not have a radiation laboratory certified for radon testing.
- The proposed project does include an elevated control room, whose daily occupancy has not yet been determined. The control room will be located on the second floor within a steel encased container that will be placed aboveground over a concrete pad and anchored. This further limit potential radon or intrusion into the work area.

As part of the evaluation for this determination, PRDOH sent information requests to six (6) local agencies at the state and federal levels. We received responses from the following agencies:

- United States Geological Survey;
- Centers for Disease Control and Prevention;
- Puerto Rico Department of Health; and
- United States Environmental Protection Agency.

The agencies mentioned above confirmed the lack of scientific data on Radon testing for Puerto Rico and the technical difficulties that we face to comply with HUD's Radon testing requirement. For the above-mentioned reasons, Radon testing is infeasible and impracticable for this property, and no further consideration of Radon is needed for the environmental review.

Radon Attachments



August 20, 2024

Mrs. Carmen R. Guerrero Pérez
Director
Caribbean Environmental Protection Division
City View Plaza II – Suite 7000
#48 Rd. 165 km 1.2
Guaynabo, PR 00968-8069

Via email: guerrero.carmen@epa.gov

RE: Request for information regarding available data on radon testing and levels within Puerto Rico

The Puerto Rico Department of Housing (PRDOH) kindly requests your assistance in gathering data, information, or reports related to radon testing in Puerto Rico, as this information is crucial for our compliance with the U.S. Department of Housing and Urban Development (HUD) Community Planning and Development (CPD) Notice CDP-23-103.

This Notice emphasizes the importance of radon testing and mitigation in ensuring safe living environments, particularly in HUD-assisted properties. PRDOH, as the grantee of the Community Development Block Grant for Disaster Recovery and Mitigation (CDBG-DR/MIT), is responsible for ensuring compliance with environmental requirements under CDBG-DR/MIT programs. To fulfill our obligations under this Notice, we must compile comprehensive and up-to-date information on radon levels, testing practices, and any mitigation efforts within the islands of Puerto Rico.

Specifically, we are seeking for possible availability of the following information:

Radon testing data – Results from radon testing conducted within your agency's purview, including details on location, testing methods, and recorded radon levels.

Reports and assessments – Any reports, studies, or assessments your agency has produced or commissioned that address radon testing or mitigation.

Policies and guidelines – Information or any policy, guideline, or protocol your agency follows concerning radon testing, exposure limits, or mitigation.

Historical data – If available, historical data or trends in radon levels within the regions you monitor that may impact HUD-assisted housing.

This information is vital to ensure that our radon management strategies are practical and compliant with federal requirements. If some of this information may be sensitive or confidential, we are prepared to discuss any necessary agreements or protocols for sharing this data securely.

Please let us know if you require additional details or have any questions regarding this request. We would greatly appreciate your response by September 15, 2024, so we can incorporate this data into our ongoing compliance efforts.

Thank you in advance for your cooperation and support. We look forward to working together on this critical initiative.

Sincerely,

William O. Rodríguez Rodríguez, Esq.
Secretary

Cc: [Mr. Oleg Pavelko, \[Pavelko.Oleg@epa.gov\]\(mailto:Oleg.Pavelko_Pavelko.Oleg@epa.gov\)](mailto:Oleg.Pavelko_Pavelko.Oleg@epa.gov)
[Mr. Matthew Lautita, \[Lautita.Matthew@epa.gov\]\(mailto:Matthew.Lautita.Lautita.Matthew@epa.gov\)](mailto:Matthew.Lautita.Lautita.Matthew@epa.gov)



August 20, 2024

Dr. Silvina Cancelos
Professor
College of Engineering
University of Puerto Rico – Mayagüez Campus
259 Norte Blvd. Alfonso Valdés Cobián
Mayagüez, Puerto Rico

Via email: silvina.cancelos@upr.edu

RE: Request for information regarding available data on radon testing and levels within Puerto Rico

The Puerto Rico Department of Housing (PRDOH) kindly requests your assistance in gathering data, information, or reports related to radon testing in Puerto Rico, as this information is crucial for our compliance with the U.S. Department of Housing and Urban Development (HUD) Community Planning and Development (CPD) Notice CDP-23-103.

This Notice emphasizes the importance of radon testing and mitigation in ensuring safe living environments, particularly in HUD-assisted properties. PRDOH, as the grantee of the Community Development Block Grant for Disaster Recovery and Mitigation (CDBG-DR/MIT), is responsible for ensuring compliance with environmental requirements under CDBG-DR/MIT programs. To fulfill our obligations under this Notice, we must compile comprehensive and up-to-date information on radon levels, testing practices, and any mitigation efforts within the islands of Puerto Rico.

Specifically, we are seeking for possible availability of the following information:

Radon testing data – Results from radon testing conducted within your agency's purview, including details on location, testing methods, and recorded radon levels.

Reports and assessments – Any reports, studies, or assessments your agency has produced or commissioned that address radon testing or mitigation.

Policies and guidelines – Information or any policy, guideline, or protocol your agency follows concerning radon testing, exposure limits, or mitigation.

Historical data – If available, historical data or trends in radon levels within the regions you monitor that may impact HUD-assisted housing.

This information is vital to ensure that our radon management strategies are practical and compliant with federal requirements. If some of this information may be sensitive or confidential, we are prepared to discuss any necessary agreements or protocols for sharing this data securely.

Please let us know if you require additional details or have any questions regarding this request. We would greatly appreciate your response by September 15, 2024, so we can incorporate this data into our ongoing compliance efforts.

Thank you in advance for your cooperation and support. We look forward to working together on this critical initiative.

Sincerely,

William O. Rodríguez Rodríguez, Esq.
Secretary

Cc: [Dr. Carlos Marín, \[carlos.marin3@upr.edu\]\(mailto:Carlos.Marin3@upr.edu\)](mailto:Dr.Carlos.Marin_Carlos.Marin3@upr.edu)



August 20, 2024

Dr. Jessica Izarry
Director
Office of Island Affairs
U.S. Centers for Disease Control and Prevention
1324 CII Canada, San Juan, 00920
Guaynabo, PR 00968-8069

Via email: OIA@cdc.gov

RE: Request for Information regarding available data on radon testing and levels within Puerto Rico

The Puerto Rico Department of Housing (PRDOH) kindly requests your assistance in gathering data, information, or reports related to radon testing in Puerto Rico, as this information is crucial for our compliance with the U.S. Department of Housing and Urban Development (HUD) Community Planning and Development (CPD) Notice CDP-23-103.

This Notice emphasizes the importance of radon testing and mitigation in ensuring safe living environments, particularly in HUD-assisted properties. PRDOH, as the grantee of the Community Development Block Grant for Disaster Recovery and Mitigation (CDBG-DR/MIT), is responsible for ensuring compliance with environmental requirements under CDBG-DR/MIT programs. To fulfill our obligations under this Notice, we must compile comprehensive and up-to-date information on radon levels, testing practices, and any mitigation efforts within the islands of Puerto Rico.

Specifically, we are seeking for possible availability of the following information:

Radon testing data – Results from radon testing conducted within your agency's purview, including details on location, testing methods, and recorded radon levels.

Reports and assessments – Any reports, studies, or assessments your agency has produced or commissioned that address radon testing or mitigation.

Policies and guidelines – Information or any policy, guideline, or protocol your agency follows concerning radon testing, exposure limits, or mitigation.

Historical data – if available, historical data or trends in radon levels within the regions you monitor that may impact HUD-assisted housing.

This information is vital to ensure that our radon management strategies are practical and compliant with federal requirements, if some of this information may be sensitive or confidential, we are prepared to discuss any necessary agreements or protocols for sharing this data securely.

Please let us know if you require additional details or have any questions regarding this request. We would greatly appreciate your response by September 15, 2024, so we can incorporate this data into our ongoing compliance efforts.

Thank you in advance for your cooperation and support. We look forward to working together on this critical initiative.

Sincerely,

William O. Rodríguez Rodríguez, Esq.
Secretary



August 20, 2024

Mrs. Anais Rodríguez
Secretary
Puerto Rico Department of Natural Resources
Carretera 8838, km. 6.3, Sector El Cinco,
Río Piedras San Juan, PR 00926

Via email: anais.rodriguez@dma.pr.gov

RE: Request for Information regarding available data on radon testing and levels within Puerto Rico

The Puerto Rico Department of Housing (PRDOH) kindly requests your assistance in gathering data, information, or reports related to radon testing in Puerto Rico, as this information is crucial for our compliance with the U.S. Department of Housing and Urban Development (HUD) Community Planning and Development (CPD) Notice CDP-23-103.

This Notice emphasizes the importance of radon testing and mitigation in ensuring safe living environments, particularly in HUD-assisted properties. PRDOH, as the grantee of the Community Development Block Grant for Disaster Recovery and Mitigation (CDBG-DR/MIT), is responsible for ensuring compliance with environmental requirements under CDBG-DR/MIT programs. To fulfill our obligations under this Notice, we must compile comprehensive and up-to-date information on radon levels, testing practices, and any mitigation efforts within the islands of Puerto Rico.

Specifically, we are seeking for possible availability of the following information:

Radon testing data – Results from radon testing conducted within your agency's purview, including details on location, testing methods, and recorded radon levels.

Reports and assessments – Any reports, studies, or assessments your agency has produced or commissioned that address radon testing or mitigation.

Policies and guidelines – Information or any policy, guideline, or protocol your agency follows concerning radon testing, exposure limits, or mitigation.

Historical data – if available, historical data or trends in radon levels within the regions you monitor that may impact HUD-assisted housing.

This information is vital to ensure that our radon management strategies are practical and compliant with federal requirements, if some of this information may be sensitive or confidential, we are prepared to discuss any necessary agreements or protocols for sharing this data securely.

Please let us know if you require additional details or have any questions regarding this request. We would greatly appreciate your response by September 15, 2024, so we can incorporate this data into our ongoing compliance efforts.

Thank you in advance for your cooperation and support. We look forward to working together on this critical initiative.

Sincerely,

William O. Rodríguez Rodríguez, Esq.
Secretary

Cc: Mr. Luis Márquez, secretariogaire@dma.pr.gov
Eng. Amarilys Rosario, aire@dma.pr.gov
Mrs. Elid Ortega, ortega@dma.pr.gov



August 20, 2024

Dr. Carlos R. Mellado López
Secretary
Puerto Rico Department of Health
PO Box 70184
San Juan, PR 00936-8184

Via email: drCarlos.mellado@salud.pr.gov

RE: Request for Information regarding available data on radon testing and levels within Puerto Rico

The Puerto Rico Department of Housing (PRDOH) kindly requests your assistance in gathering data, information, or reports related to radon testing in Puerto Rico, as this information is crucial for our compliance with the U.S. Department of Housing and Urban Development (HUD) Community Planning and Development (CPD) Notice CDP-23-103.

This Notice emphasizes the importance of radon testing and mitigation in ensuring safe living environments, particularly in HUD-assisted properties. PRDOH, as the grantee of the Community Development Block Grant for Disaster Recovery and Mitigation (CDBG-DR/MIT), is responsible for ensuring compliance with environmental requirements under CDBG-DR/MIT programs. To fulfill our obligations under this Notice, we must compile comprehensive and up-to-date information on radon levels, testing practices, and any mitigation efforts within the islands of Puerto Rico.

Specifically, we are seeking for possible availability of the following information:

Radon testing data – Results from radon testing conducted within your agency's purview, including details on location, testing methods, and recorded radon levels.

Reports and assessments – Any reports, studies, or assessments your agency has produced or commissioned that address radon testing or mitigation.



August 20, 2024

Mrs. Holly Weyers
Regional Director, Southeast – Puerto Rico
US Geological Survey
3916 Sunset Ridge Road
Raleigh, NC 27607

Via email: hswyers@usgs.gov

RE: Request for Information regarding available data on radon testing and levels within Puerto Rico

The Puerto Rico Department of Housing (PRDOH) kindly requests your assistance in gathering data, information, or reports related to radon testing in Puerto Rico, as this information is crucial for our compliance with the U.S. Department of Housing and Urban Development (HUD) Community Planning and Development (CPD) Notice CDP-23-103.

This Notice emphasizes the importance of radon testing and mitigation in ensuring safe living environments, particularly in HUD-assisted properties. PRDOH, as the grantee of the Community Development Block Grant for Disaster Recovery and Mitigation (CDBG-DR/MIT), is responsible for ensuring compliance with environmental requirements under CDBG-DR/MIT programs. To fulfill our obligations under this Notice, we must compile comprehensive and up-to-date information on radon levels, testing practices, and any mitigation efforts within the islands of Puerto Rico.

Specifically, we are seeking for possible availability of the following information:

Radon testing data – Results from radon testing conducted within your agency's purview, including details on location, testing methods, and recorded radon levels.

Reports and assessments – Any reports, studies, or assessments your agency has produced or commissioned that address radon testing or mitigation.

Policies and guidelines – Information or any policy, guideline, or protocol your agency follows concerning radon testing, exposure limits, or mitigation.

Historical data – If available, historical data or trends in radon levels within the regions you monitor that may impact HUD-assisted housing.

This information is vital to ensure that our radon management strategies are practical and compliant with federal requirements. If some of this information may be sensitive or confidential, we are prepared to discuss any necessary agreements or protocols for sharing this data securely.

Please let us know if you require additional details or have any questions regarding this request. We would greatly appreciate your response by September 15, 2024, so we can incorporate this data into our ongoing compliance efforts.

Thank you in advance for your cooperation and support. We look forward to working together on this critical initiative.

Sincerely,

William O. Rodríguez Rodríguez, Esq.
Secretary

Cc: Mr. Raúl Hernández Dabla, rahernandez2@salud.pr.gov

Policies and guidelines – Information or any policy, guideline, or protocol your agency follows concerning radon testing, exposure limits, or mitigation.

Historical data – If available, historical data or trends in radon levels within the regions you monitor that may impact HUD-assisted housing.

This information is vital to ensure that our radon management strategies are practical and compliant with federal requirements. If some of this information may be sensitive or confidential, we are prepared to discuss any necessary agreements or protocols for sharing this data securely.

Please let us know if you require additional details or have any questions regarding this request. We would greatly appreciate your response by September 15, 2024, so we can incorporate this data into our ongoing compliance efforts.

Thank you in advance for your cooperation and support. We look forward to working together on this critical initiative.

Sincerely,

William O. Rodríguez Rodríguez, Esq.
Secretary

Cc: Mr. R. Randall Schumann, rschumann@usgs.gov

From: Charp, Paul (CDC/NCEH/DEHSP) <pac4@cdc.gov>
Sent: Tuesday, September 3, 2024 6:36 AM
To: Miranda, Sandra (CDC/PHIC/DPS); Irizarry, Jessica (CDC/PHIC/DPS); Rzeszotarski, Peter (CDC/NCEH/DEHSP); Vinson, D. Aaron (CDC/NCEH/DEHSP)
Cc: Kostak, Liana (CDC/PHIC/DPS); Vazquez, Germaine (CDC/NCEH/DEHSP)
Subject: RE: REHi: Puerto Rico Request for Information- Randon testing and levels

Good morning, Sandra and others,

In response to the request from Mr. William Rodriguez of the Department of Housing, Government of Puerto Rico, I have reviewed all the available data within the CDC National Environmental Public Health Tracking Network system for data related to radon in Puerto Rico. In addition to the tracking data available on the internet, I also reached out to Mr. Aaron Vinson of the NCEH Tracking Branch.

I was not able to find any data in the CDC systems and this was confirmed by Mr. Vinson. We also reached out the US Environmental Protection Agency who indicated they had no radon data in their systems. Please relay this information to Mr. Rodriguez in your response to his requests

If you have any additional questions, please contact me.

Thank you and best regards,

Paul A. Charp, Ph.D., Fellow, HPS
Senior Health Physicist
Emerging Environmental Hazards and Health Effects Branch (EEHHEB)
Division of Environmental Health Science and Practice (DEHSP)
National Center for Environmental Health (NCEH)
Centers for Disease Control and Prevention (CDC)
pcharp@cdc.gov
770-488-0723 office
404.388.0614 Cell



From: Schumann, R. Randall <rschumann@usgs.gov>
Sent: Wednesday, August 21, 2024 4:39 PM
To: Melanie Medina Smaine <mmedina@vivienda.pr.gov>; Weyers, Holly S <hsweyers@usgs.gov>
Cc: Elaine Dume Mejia <Edume@vivienda.pr.gov>; Luz S Colon Ortiz <Lcolon@vivienda.pr.gov>; Aldo A. Rivera-Vazquez <aarivera@vivienda.pr.gov>
Subject: RE: Request for Information- Radon testing and levels

Dear Ms. Medina Smaine,

In the early 1990s the U.S. Geological Survey (USGS) conducted geologic assessments of radon potential for all 50 states and the territories of Guam and Puerto Rico, in collaboration with the U.S. EPA. I conducted the geologic radon potential assessment for Puerto Rico. The PDF file of the report is too large to attach to this message but it can be obtained at <https://pubs.usgs.gov/of/1993/0292k/report.pdf>. The USGS did not conduct indoor radon testing and we did not conduct field studies associated with this assessment; it was based on existing data. Mr. David Saldana of the Puerto Rico Department of Health kindly provided us with data for 610 homes that were tested for indoor radon by his agency between 1993 and 1995, which are summarized in the report. I am not aware of any other radon-related geologic studies conducted in the Commonwealth of Puerto Rico by the U.S. Geological Survey.

Best regards,

R. Randall Schumann
Scientist Emeritus
U.S. Geological Survey
Geosciences and Environmental Change Science Center
Denver, Colorado, USA
rschumann@usgs.gov
<https://www.usgs.gov/staff-profiles/r-randall-schumann>

From: Raul Hernandez Doble <rhernandez2@salud.pr.gov>
Sent: Wednesday, August 21, 2024 2:13:31 PM
To: Melanie Medina Smaine <mmedina@vivienda.pr.gov>; Dr. Carlos Mellado <drcarlos.mellado@salud.pr.gov>
Cc: Elaine Dume Mejia <Edume@vivienda.pr.gov>; Luz S Colon Ortiz <Lcolon@vivienda.pr.gov>; Aldo A. Rivera-Vazquez <aarivera@vivienda.pr.gov>; Mayra Toro Tirado <mtoro@salud.pr.gov>
Subject: RE: [EXTERNAL]Request for Information- Randon testing and levels

Good afternoon. Ms. Medina

I regret to inform that we do not have any recent information on radon testing, since we do not have a certified radiation laboratory certified for radon testing. There are companies that sell test kits available online that can be done and mailed to a testing laboratory. There are also lists of radon contractors and these companies that process radon testing cartridges with instructions, on the Environmental Protection Agency Indoor air Quality web page. The last radon study in Puerto Rico done by the PR Department of Health was done on the year 1993.

Raul Hernandez Doble
Director, Seccion Salud Radiologica
Division de Salud Ambiental
Secretaria Auxiliar para la Vigilancia y la Proteccion de la Salud Publica
rhernandez2@salud.gov.pr
Phone: (787)765-2929 ext. 3210

From: Reyes, Brenda <Reyes.Brenda@epa.gov>
Sent: Wednesday, September 18, 2024 11:48 AM
To: Cesar O Rodriguez Santos <cesarrodriguez@drna.pr.gov>; Maritza Rosa Olivares <maritzarosaolivares@drna.pr.gov>; Silvina Cancelos Mancini <silvina.cancelos@upr.edu>; Melanie Medina Smaine <mmedina@vivienda.pr.gov>
Cc: Elaine Dume Mejia <Edume@vivienda.pr.gov>; Luz S Colon Ortiz <Lcolon@vivienda.pr.gov>; Aldo A. Rivera-Vazquez <aarivera@vivienda.pr.gov>; Povetko, Oleg (he/him/his) <Povetko.Oleg@epa.gov>
Subject: RE: Request for Information- Randon testing and levels

Saludos.

La EPA esta trabajando una respuesta a su petición. Se sometió borrador a la directora y el subdirector para su aprobación y firma.

Brenda Reyes Tomassini
Public Affairs
U.S. EPA
Region 2
Caribbean Environmental Protection Division
(787) 977-5869/(787) 977-5865
Mobile: 202-834-1290

From: Silvina Cancelos Mancini <silvina.cancelos@upr.edu>
Sent: Friday, September 6, 2024 15:04
To: Melanie Medina Smaine <mmedina@vivienda.pr.gov>
Cc: Elaine Dume Mejia <Edume@vivienda.pr.gov>; Luz S Colon Ortiz <Lcolon@vivienda.pr.gov>; Aldo A. Rivera-Vazquez <aarivera@vivienda.pr.gov>; Maritza Rosa Olivares <maritzarosaolivares@drna.pr.gov>; Reyes, Brenda <Reyes.Brenda@epa.gov>; Povetko, Oleg <Povetko.Oleg@epa.gov>
Subject: Re: Request for Information- Randon testing and levels

Estimada Melanie Medina
Quería dejarte saber que recibimos su correo el 21 de agosto al igual que el de Maritza Rosa el pasado 4 de septiembre. Ya las personas involucradas de EPA, junto conmigo y el Dr. Marín estamos al tanto del asunto y estamos trabajando para poder enviarles la información.

Atentamente

Silvina Cancelos
Professor
Associate Director
Mechanical Engineering Department
University of Puerto Rico - Mayaguez
Call BOX 9000 Mayaguez PR 00680
Tel: 787-832-4040 ext 5956
email: silvina.cancelos@upr.edu



Bubble Dynamics Lab
University of Puerto Rico - Mayaguez



EPA REGION 2
CARIBBEAN ENVIRONMENTAL PROTECTION DIVISION

September 23, 2024

VIA EMAIL

William O. Rodriguez Rodriguez, Esq.
Secretary
Puerto Rico Department of Housing
Barbosa Ave. 606 Building Juan C. Cordero
San Juan, PR 00917
Email: W.Rodriguez@vivienda.pr.gov

RE: EPA Response to August 20, 2024 request for information of data on radon testing and levels in Puerto Rico

Dear Honorable Secretary Rodriguez Rodriguez:

This communication is in response to your letter of August 20, 2024 addressed to the Puerto Rico Department of Natural and Environmental Resources (DNER) and referred to the U.S. Environmental Protection Agency (EPA) regarding available data on radon testing and levels within Puerto Rico.

EPA's National Radon Action Plan 2021–2025 sets a goal for the nation to find, fix and prevent high indoor radon levels in 8 million buildings by 2025 and prevent 3,500 lung cancer deaths per year. Under this Plan, leaders from across multiple sectors are working together to plan, guide, and sustain nationwide action to prevent exposure to radon.

Due to the lack of data in Puerto Rico, EPA undertook an investigation in collaboration with the University of Puerto Rico-Mayaguez (UPRM) Campus, Departments of Civil Engineering and Surveying and Mechanical Engineering, to find out if radon presented a problem in Puerto Rico. Up until 2021, the only data we had for Puerto Rico was a 1993-1995 mail-in radon screening study referred to by the U.S. Geological Survey report (USGS, 1995) in which the USGS concluded that several areas of Puerto Rico have the geologic potential to generate indoor radon levels exceeding the EPA Action Level of 4 pCi/L (picocuries per liter), perhaps locally reaching very high levels above 50 pCi/L, if a house construction and

ventilation allow for soil-gas radon to enter and concentrate within the structure.¹ According to the USGS report, most of these areas are located in the northwest part of the island. Please note that the actual 1993-1995 study documentation is not available to the EPA.

Typical radon testing technology used in mainland United States (charcoal canisters or electric-powered devices) are impractical in Puerto Rico because of high humidity and power outages. The recovery and rebuilding of communities following the aftermath of 2017 Hurricanes Irma and Maria presented an opportunity to develop radon prevention and mitigation strategies in 2019. Initially, EPA sampled indoor radon air in over 170 single-family residences in the municipalities of San Sebastian, Lares, Ciales, Arecibo, Morovis, Camuy, and Hatillo and later expanded the project to other municipalities such as Rincon, Aguada, Aguadilla, Isabela, Quebradillas, Barceloneta and Vega Baja. The quality assurance protocols were anchored in American National Standards Institute/American Association of Radon Scientists and Technologists (ANSI/AARST) standards of practice (ANSI/AARS, 2019). The sampling was designed in two stages: scoping and confirmatory sampling. The scoping sampling was conducted using Corentium Home (CH) electronic monitors and E-Perm systems. Locations measuring above the EPA Action Level of 4 pCi/L with CH were measured at the second stage of the sampling using RAD7 and Corentium Pro Continuous Radon Monitors (CRMs). Nationally certified radon sampling professionals led by one such professional from the UPRM conducted confirmatory sampling in the second stage. Also, during the study, the nationally certified radon mitigation professionals inspected several homes with elevated indoor radon levels.

Mapping radon in Puerto Rico proved to be a complicated endeavor given the COVID-19 pandemic in 2020. EPA and UPRM continue to work on the project, however, results have not been finalized, and no scientific report has been published yet. Unfortunately, EPA cannot share preliminary data at this time because it contains privileged information. Nevertheless, preliminary data from the study does show homes with levels over 4 pCi/L (EPA Action Level) that might need mitigation to protect the health of their inhabitants.

Although many states have developed laws and regulations governing radon disclosure, certification, and mitigation, Puerto Rico lacks legislation or mandatory radon testing provisions for new construction, remodeling, selling or buying homes. Given this loophole and aiming to answer your request, the EPA can provide information on Best Management Practices for sampling indoor radon in Puerto Rico.

¹ Reference: USGS. Geologic Radon Potential of Guam and Puerto Rico, Report 93-292-K. Washington, DC: USGS. Retrieved 9/11/2024, from <https://pubs.usgs.gov/of/1993/0292k/report.pdf>.

CITY VIEW PLAZA II BUILDING, 7TH FLOOR
ROUTE 185 GUAYNABO, PR 00988

2

If you have any questions or need any additional information, please contact me at 787-977-5865 or guerrero.carmen@epa.gov or have your staff contact Reyes, Brenda at reyes.brenda@epa.gov or (787) 977-5869.

Sincerely,
CARMEN GUERRERO PEREZ
Carmen R. Guerrero Pérez
Director

Digitally signed by
CARMEN GUERRERO PEREZ
Date: 2024.09.23 09:41:39
-04'00'

cc: Roberto Mendez, Esq (Acting Secretary, PR Department of Natural and Env. Resources)
Melany Medina: mmedina@vivienda.pr.gov
Elaine Dume Mejia: Edume@vivienda.pr.gov
Luz S Colon Ortiz: Lcolon@vivienda.pr.gov
Aldo A. Rivera-Vazquez: aarivera@vivienda.pr.gov
Cesar O. Rodriguez: cesarrodriiguez@drna.pr.gov
Marita Rosa Olivares: maritzarosaolivares@drna.pr.gov

Appendix 9

Endangered Species Act



United States Department of the Interior

FISH AND WILDLIFE SERVICE
Caribbean Ecological Services Field Office
Bayamón | Mayagüez | Maricao | Río Grande | St Croix
P.O. Box 491
Boquerón, Puerto Rico 00622



In Reply Refer to:
FWS/R4/CESFO/72029-Gen

Submitted Via Electronic Mail: jcperez@vivienda.pr.gov

Juan Carlos Pérez-Bofill, PE, MEng.
Director – Disaster Recovery CDBG-DR Program
Puerto Rico Department of Housing
P.O. Box 21365
San Juan, P.R 00928-1365

Re: IPGM-00375 ECONO Energy Project,
Canóvanas, Puerto Rico

Dear Mr. Pérez-Bofill

Thank you for your letter dated October 18, 2024, requesting informal consultation on the above referenced project. As per your request, our comments are provided under the Endangered Species Act (Act) (87 Stat. 884, as amended; 16 United States Code 1531 et seq.), and the Fish and Wildlife Coordination Act (48 Stat. 401, as amended; 16 U.S.C. 661 et seq.).

The Puerto Rico Department of Housing (PRDOH) is proposing the construction and installation of a Hybrid Power Plant for the Econo supermarket chain's distribution center within a commercial facility of approximately 86 acres (346,895.21 m²) of land located just south of State Road PR-3, at Km. 16.2 in Canovanillas Ward (18°22'25.0"N 65°54'23.6"W) in the municipality of Canóvanas.

Using the U.S. Fish and Wildlife Service's (Service) Information for Planning and Consultation (IPaC) system, the PRDOH has determined that the proposed project site is located within the range of the Puerto Rican boa (*Chilabothrus inornatus*).

The Caribbean Determination Key (DKey) in the IPaC application was used to evaluate the potential impacts to federally listed species for this project (Project code: 2024-0098241). Based on the answers provided, a consistency letter was obtained for the Puerto Rican boa, which determined that the proposed actions for this project will have no effect (NE) on this species.

Based on the nature of the project, scope of work, information available, and analysis of the site which will require ground disturbance activity and the proximity to undeveloped land, PRDOH has determined that the proposed project may affect, but is not likely to adversely affect (NLAA)

the Puerto Rican boa instead of the NE obtained by using the DKey. Conservation measures will be implemented in case an encounter with this species occur.

We have reviewed the information provided and our files, and concur with PRDOH's determination that the proposed project may affect, but is not likely to adversely affect the Puerto Rican boa with the implementation of the conservation measures.

In view of this, we believe that requirements of section 7 of the Endangered Species Act (Act) have been satisfied. However, obligations under section 7 of the Act must be reconsidered if: (1) new information reveals impact of this identified action that may affect listed species or critical habitat in a manner that was not previously considered; (2) this action is subsequently modified in a manner not previously considered in this assessment; or, (3) a new species is listed, or critical habitat determined that may be affected by the identified action.

Thank you for the opportunity to comment on this project. If you have any questions or require additional information, please contact us via email at caribbean_es@fws.gov or by phone at (786) 244-0081.

Sincerely,

LOURDES
MENA

Digitally signed by
LOURDES MENA
Date: 2024.12.11
20:27:32 -04'00'

Lourdes Mena
Field Supervisor

dr

cc:
HUD

October 11, 2024

Applicant ID: IPGM-00375

Street Address: PR-3, Km. 16.2, Lot 3, Canovanillas Ward

Municipality: Canóvanas

RE: NLAA Determination for IPGM-00375

EXECUTIVE SUMMARY

Section 7 of the Endangered Species Act (ESA) mandates that federal agencies ensure the actions that they authorize, fund, or carry out shall not jeopardize the continued existence of federally listed plants and animals or result in the adverse modification or destruction of designated critical habitat. Where their actions may affect resources protected by the ESA, agencies must consult with the Fish and Wildlife Service and/or the National Marine Fisheries Service (“FWS” and “NMFS” or “the Services”).

This memo serves to document that the proposed project, IPGM-00375, located at Road PR-3, Km. 16.2, Lot 3, Canovanillas Ward, Canóvanas, Puerto Rico (Parcel ID# 117-000-003-01-000) was reviewed in accordance with Section 7 of the Endangered Species Act of 1973 (16 USC 1536) as well as the Fish and Wildlife Coordination Act (47 Stat. 401, as amended; 16 U.S.C. 661 et seq.) by a qualified Biologist, resulting in a ‘Not Likely to Adversely Affect’ determination.

CDBG-MIT funds represent a unique and significant opportunity for Puerto Rico to carry out strategic and high-impact activities to mitigate disaster risks and reduce future losses. Unlike Disaster Recovery funds, which have been awarded for hurricane-specific recovery, mitigation assignments can fund projects of a varying nature to serve the Island’s most important mitigation needs, regardless of tie-back to a specific disaster. The Puerto Rico Department of Housing is the Responsible Entity for this program.

Project Description:

The property is a commercial food warehouse and distribution center for the Econo Supermarket chain. The project scope involves the construction/installation of a Hybrid Power Plant for the Econo supermarket chain’s distribution center in Canóvanas, Puerto Rico. The proposed power plant will use photovoltaic panels and a natural gas engine in conjunction with a Battery Energy Storage System (BESS) to provide stability to the electrical power needs at the site. The site is supplied by LUMA Energy, the power company responsible for power distribution and power transmission in Puerto Rico. However, the energy supply is unstable. Currently, the facility has emergency power generation from two (2) diesel-powered engines of 2,500 kWe, but these cannot be used for prolonged periods of time. These emergency-power engines will continue to be available at the site in addition to the proposed equipment.

The proposed action will provide the facility with an efficient and reliable energy source, to ensure operation continuity year-round, reducing threats to food security and distribution on the island. Econo is one of the largest food supplier on the island, and the

site serves as the main distribution center for the supermarket chain. This proposed project will provide electrical autonomy to the facility in the event of catastrophic events that affect the island-wide power supply and distribution. **Appendix 1** includes a technical handout provided by the project's designer.

Existing Conditions:

The proposed activity will take place within a commercial facility of approximately 86 acres (346,895.21 m²) of land located just south of PR-3, at Km. 16.2 in Canovanillas Ward, (coordinates 18.373613°, -65.906549°). Satellite imagery obtained from Google Earth Pro (refer to Location Map in **Appendix 2**) shows that the site is composed of several buildings and has previous and impervious surfaces with limited flora available. The actual activities will take place in an estimated area of over 415 square meters on the site's Dry Storage Building and some 130 square meters on the ground level, adjacent to the building. Project area conditions can be observed in the photographs in **Appendix 3**.

According to historical imagery from Google Earth Pro (see **Appendix 4**), prior to its current use, the parcel had been operating as a quarry before it was modified to house the current facilities. The construction at the site took place between the years 2019 and 2021.

A topographic map is included (see **Appendix 5**). The project is located in Zone X on the FEMA Flood Insurance Rate Maps (FIRM) (**Appendix 6**), panels number 72000C0395J and 72000C0760J, both with effective date of 11/18/2009, while portions of the property are located in Zone A of the ABFE map (same panel numbers, dated Dec 11, 2018) (**Appendix 7**).

According to the National Wetland Inventory (NWI) data (see **Appendix 8**), there is a mapped riverine to the East and on the West portion of the site. There are also mapped Freshwater Emergent Wetlands on the North portion of the property and to the Northeast. These areas were impacted during the construction of the site. The riverine to the west was re-directed, while the riverine area to the East remains with its course, due North, and crosses underneath road PR-3. Based on historical imagery referenced above, Wetland areas to the North we impacted and filled to construct access roads to and from the warehouse areas, while Wetland areas to the Northeast remain in place. The area related to the riverine wetland was preserved and a buffer established during the site development and construction to ensure its protection. Also, a retention pond exists directly to the East of the property which helps to control storm water discharges to the wetland. The proposed activities will not directly or indirectly impact any of the wetland areas identified to be outside the perimeter of the site because all the construction activities will occur within the exiting developed property and best management practices will be established to avoid impacts offsite.

Species List:

As indicated by the Official Species List obtained from the Information for Planning and Consultation (IPaC) system (see **Appendix 9**) and USFWS Critical Habitat data (see **Appendix 10**), the proposed project lies within the range of the following federally listed species and/or critical habitats:

Species	Status
Puerto Rican Boa (<i>Chilabothrus inornatus</i>)	Endangered

Critical Habitat
None

Effect Determination:

Based on a review of site photos and other information gathered during a site visit (see **Appendix 3**), none of the species listed above were observed in the vicinity of the proposed project activities and no critical habitat was identified within the proposed project area. Furthermore, the project area is developed and does not have areas with flora or fauna species of concern.

After analysis of the project site and the information available, including the IPaC species list and available Dkey(s), critical habitat data, nature of the project, previous site disturbance, and scope of project activities, a determination of 'No Effect' was made from desktop analysis. Following discussion with the responsible entity (PRDOH), the ground disturbance activity and proximity to undeveloped land elevated the effect determination to the following Effect Determination:

Species	Effect Determination	Conservation Measures to be Implemented (if needed)
Puerto Rican Boa (<i>Chilabothrus inornatus</i>)	Not Likely to Adversely Affect (NLAA)	Conservation Measures for the Puerto Rican Boa 2024

SPECIES ANALYSIS

Puerto Rican Boa (*Chilabothrus inornatus*)

Considered to be a habitat generalist, the Puerto Rican Boa tolerates a wide variety of terrestrial and arboreal habitats, including rocky areas, haystack hill, trees and branches, rotting stumps, caves, plantations, various types of forested areas such as karst and mangrove forests, forested urban and rural areas, and along streams and road edges. The IPaC Determination Key (Dkey) for the Puerto Rican Boa, 06/02/2024, was used to evaluate the potential impacts to federally listed species from this project. Based on the Dkey responses, it was determined that the proposed project will have a determination of 'No Effect' on the Puerto Rican Boa (**Appendix 9**). As addressed above, the Responsible Entity considers the effect determination at NLAA given ground disturbance activity and proximity to undeveloped vacant land.

If a Puerto Rican Boa is found in the project activity site, work shall cease until the Boa moves off on its own. If the Boa does not move off, the Construction Manager shall contact the Puerto Rico Department of Natural and Environmental Resources and ask for them to relocate the Boa as explained in Conservation Measures for the Puerto Rican Boa 2024 (**Appendix 11**).

We kindly ask your concurrence with this effect determination as part of Informal Consultation as: Not Likely to Adversely Affect (NLAA) the Puerto Rican Boa.

Héctor L Sánchez Cruz
Senior Biologist



10/11/2024
Date

Appendix List

IPGM-00375 – USFWS documents

1	Technical Handout – project description details
2	Site location map
3	Photos of existing site conditions
4	Historical imagery from Google Earth (4A – 4C)
5	Topographic Map
6	Flood Insurance Rate Map
7	Advisory Base Flood Elevation Map
8	Wetland Map
9	IPaC Species list (06/01/2024) and Consistency letter (06/02/2024)
10	Critical Habitat Map
11	Conservation Measures for the Puerto Rican Boa 2024

Appendix 1:

Technical Handout – Project description details



SAMPOL
RELIABLE ENGINEERS

**HIGH EFFICIENCY HYBRID POWER PLANT
ECONO DISTRIBUTION CENTER
Canóvanas, Puerto Rico
SAM22-010374-17
June 2024**



SAMPOL



INDEX

1. SAMPOL GROUP
 - INTERNATIONAL PRESENCE
 - INTEGRAL SOLUTIONS
 - SAMPOL AND ENERGY
 - ESCO CONTRACTS
2. PROJECT SUMMARY
3. HIGH-EFFICIENCY HYBRID POWER PLANT ECONO DISTRIBUTION CENTER
 - TECHNICAL PROPOSAL – ENERGY FLOW
 - TECHNICAL PROPOSAL – PV PLANT
 - TECHNICAL PROPOSAL – HYBRID POWER PLANT
4. SAMPOL ECONOMIC PROPOSAL
5. DRAWINGS
6. SCOPE OF MATRIX
7. SCHEDULE





1 SAMPOL GROUP



About us

At SAMPOL we are a Spanish multinational group with over 85 years history.

Leaders in applied engineering projects with a special focus on energy, renewable energies, energy saving solutions, sustainability and digitization.

With strong presence in the industrial, hotel and airport sectors.



ENERGY AND
SUSTAINABILITY



INTEGRAL PROJECTS



DIGITAL



INDUSTRY



HOTELS



TRANSPORTS

More than 300 engineers integrate our human team



ENERGY AND SUSTAINABILITY

Energy plants which combine cogeneration with renewable energies and energy-saving solutions

Plants in ESCO/PPA as well as EPC modality

Experts in high energy efficiency systems which integrate photovoltaic, batteries, biogas, hydrogen or geothermal energy

Water: water management plants
Desalination, Purification, etc.

Energy and water integral management
We are responsible of the plants' operation and maintenance, offering all services to the client

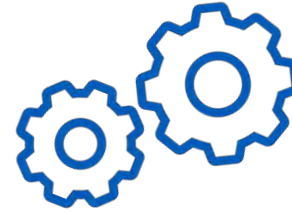

INTEGRAL PROJECTS

MEP installations Integral solutions for Electricity, HVAC, ACS, plumbing Networks, safety, fire protection Automation systems and SCADAS, hardware and software integration

Highly specialized in airport sector: Visual Aid Systems, Installations Control systems, Energy Control Systems, Aerial Navigation, Radio Aid Systems

High technic capability Complete project cycle from the design, planification and execution of the systems Commitment to technological innovation and integration

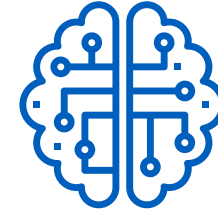

DIGITAL

Integration and development of IT solutions, products and services, which boost the digitalization processes of our clients

The scope of our expertise covers from networks and cybersafety to IoT, including our own software platforms and products for our markets

Leading the technology transformation with key solutions such as Optical Networks, Digital Twin and Specialized Cloud Applications Cloud (Icosaedro®) We focus our solutions on service mode (SaaS & IaaS) to ensure all the life cycle

14 COUNTRIES WHERE
WE HAVE
PERMANENT
PRESENCE

22 COUNTRIES IN
WHICH WE HAVE
CONDUCTED
PROJECTS

39% OF OUR TURNOVER
ABROAD

>30
COGENERATION
PLANTS

+1,500
EMPLOYEES
AROUND THE
WORLD

+1,000
MEGA WATIOS OF
INSTALLED ELECTRICAL
ENERGY

+4,000
COMPLETED
PROJECTS

International Presence



Spain



Italy



Mexico



Dominican Republic



Panama



Jamaica



Canada



Puerto Rico



Colombia



Cape Verde



Honduras



Peru



Guatemala



 Significant works

 Permanent presence

 Headquarters in Mallorca

Presence in Central America and the Caribbean



We develop **climate** actions

We **reduce** emissions

We **decrease** our clients' **carbon and hydric footprint**

We create **high energy efficiency** systems

We innovate with **green technologies**

We **digitalize** processes to achieve more **sustainable** solutions





ENERGY

30 YEARS OF EXPERIENCE

HYBRID PLANTS:
COGENERATION &
RENEWABLES



ENERGY
EFFICIENCY



PROJECTS
EPC & ESCO



SMART PLANT
MANAGEMENT



SMART O&M



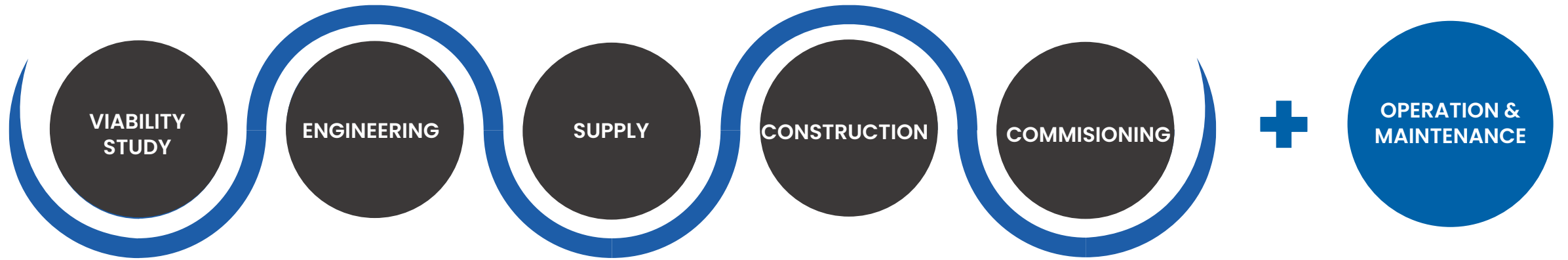

EPC

SAMPOL is responsible for the engineering, Development and construction of co/trigeneration plant

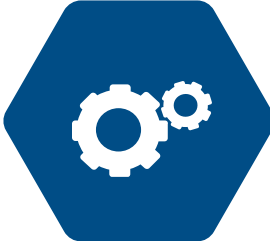

INVESTMENT

SAMPOL undertakes the investment of the project

ENERGY SUPPLY

SAMPOL ensures a reliable, efficient and secure energy supply

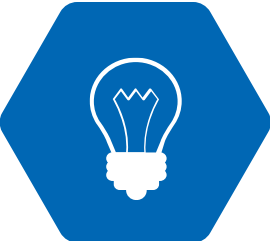

O&M

SAMPOL is responsible of the Operation and Maintenance of the installations





2 HIGH EFFICIENCY HYBRID POWER PLANT ECONO DISTRIBUTION CENTER

- **Facility location:** Canóvanas, Puerto Rico
- **Contract type:** Engineering, Procurement, and Construction (EPC)
- **Design:** Hybrid Power Plant: PV + Natural Gas Engine + BESS
- **Fuel:** Natural gas ; **Plant site elevation:** 55 ft. a.s.l.
- **Operation:** island mode / grid-tied
- **Energy demands:**
 - Night power consumption: 800 kWe
 - Day power consumption: 1,200 kWe
 - Demand 24/7
- **Current situation:**
 - Electricity consumption covered by LUMA
 - Diesel Back up engines power: 2 x 2500 kWe
- **SAMPOL proposal:**
 - High-Efficiency Hybrid Power Plant
 - Green Energy Production
 - H2-Ready
 - Carbon Footprint Reduction
 - Guaranteed availability and reliability
 - Economical savings

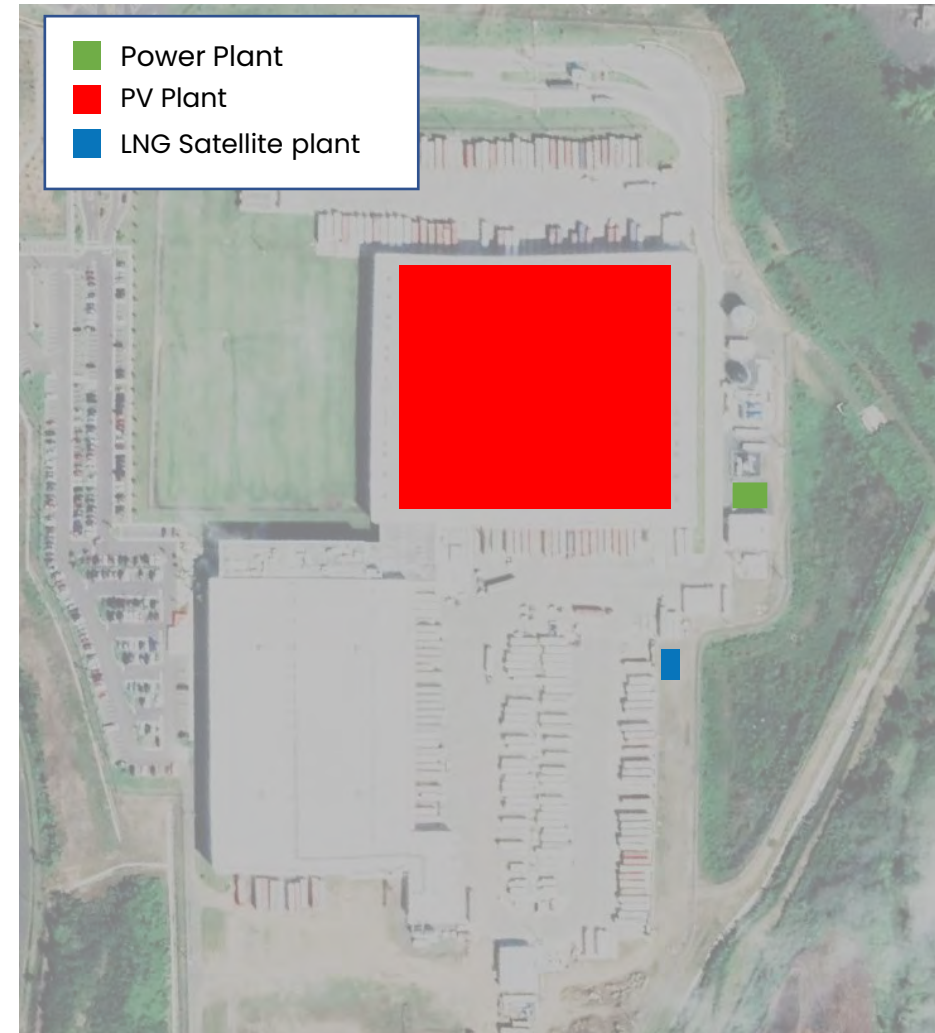

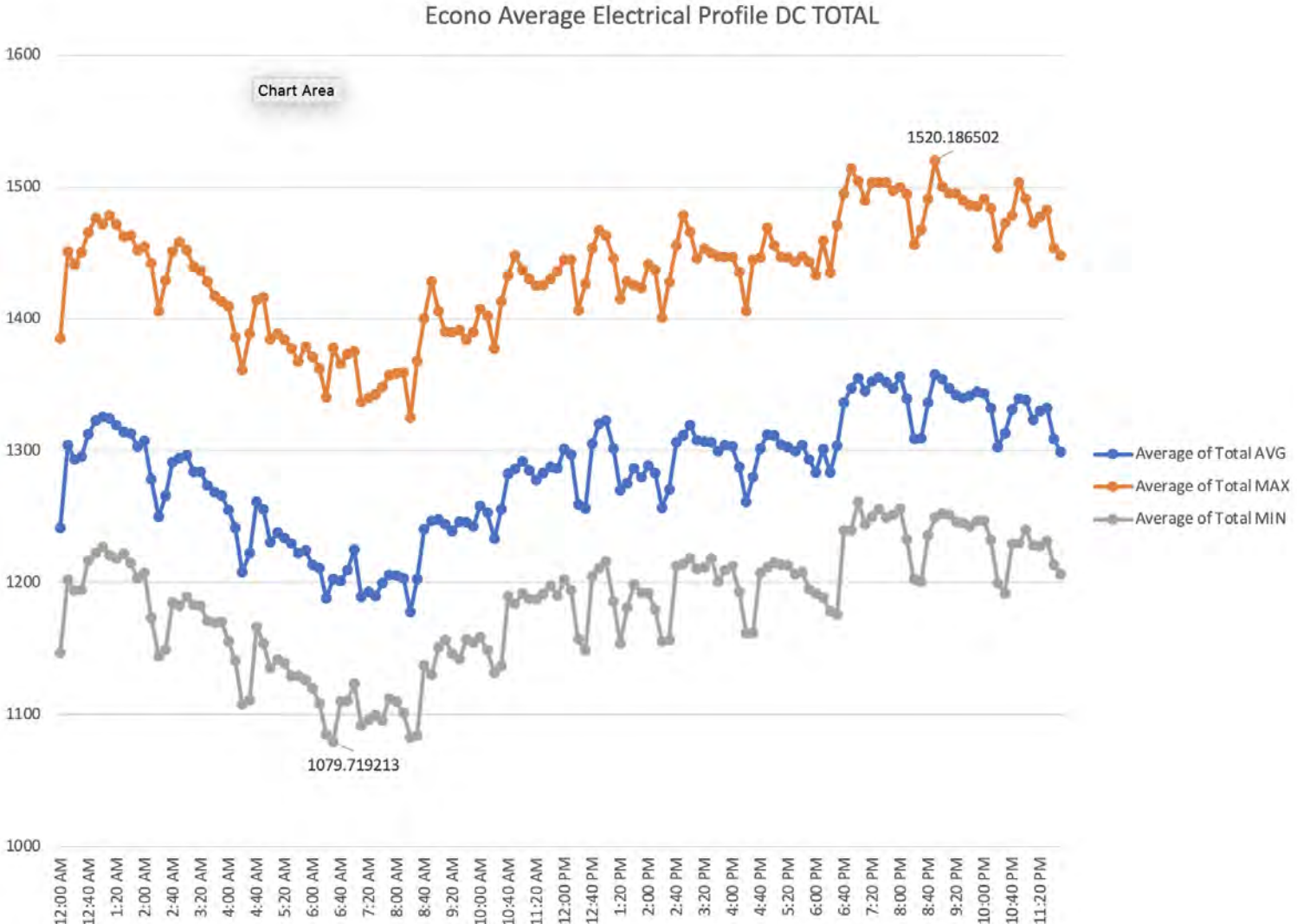



3 SAMPOL PROPOSAL

TECHNICAL PROPOSAL – ENERGY FLOW

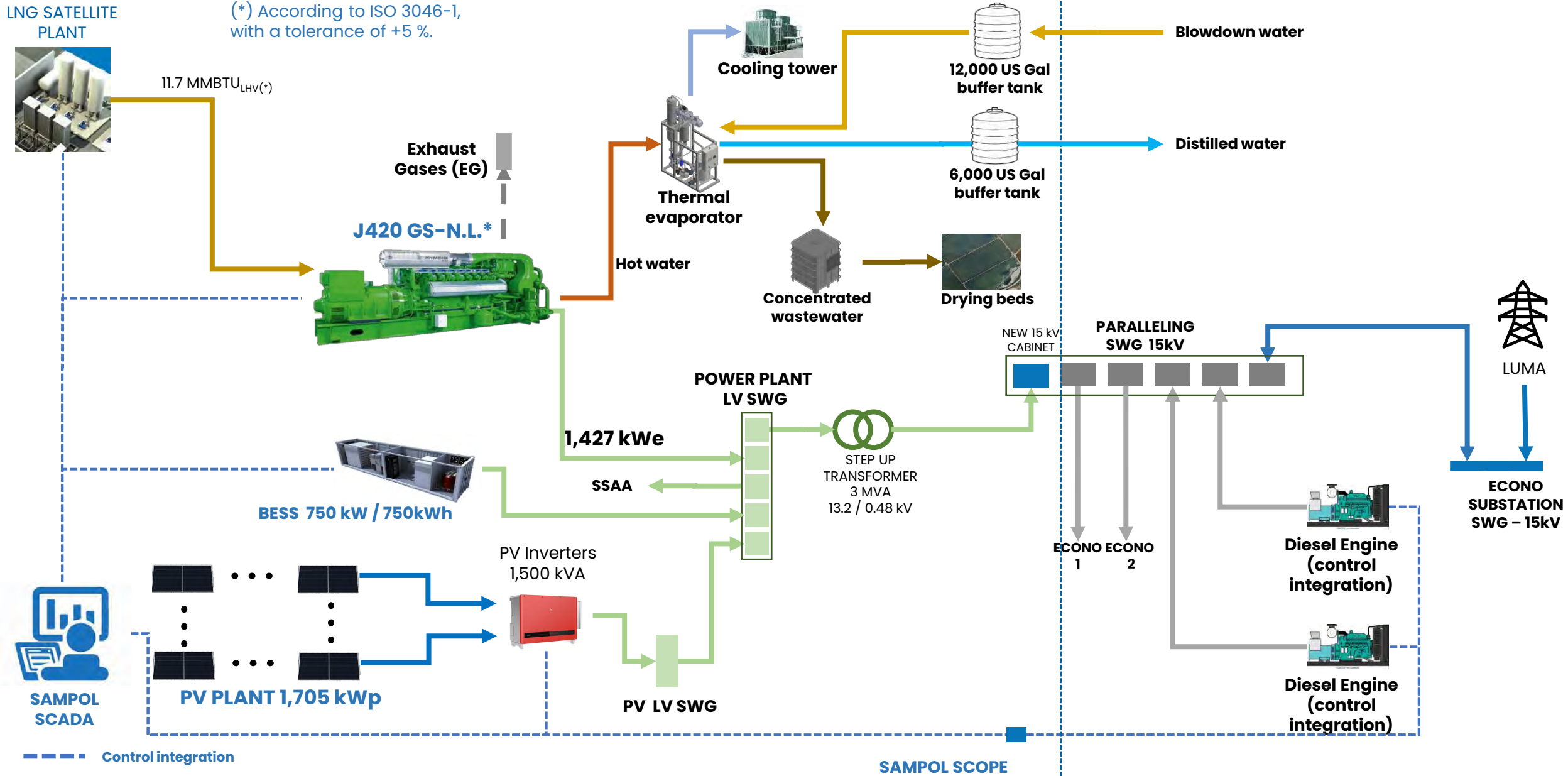

- **Design:** Photovoltaic Plant (PV) on roof connected to client installation
- **Location:** over flat roof; **Tilt:** coplanar to the roof
- **PV Plant peak power:** 1,705 kWp
- **PV Plant nominal power:** 1,500 kVA

MAIN EQUIPMENT

- 2,750 monocrystalline solar panels of 620 Wp*
- PV Inverters of 100 kVA*
- Equipment proposed as reference. The equipment will be defined during detailed engineering with similar quality and performance to the references

ELECTRICAL INSTALLATION

- CC and AC conduits, electrical protections. New LV PV SWITCHGEAR located indoor of client facilities.

PHOTOVOLTAIC STRUCTURE

- Steel support structure for coplanar installation with screws and steel anchors resistant against salt mist ambient
- Designed to resist winds velocities of 155 miles per hour.
- Structure installation will be coordinated with the contractor that guarantees the roof weatherproofing

CONSIDERATIONS

- PV inverters need internet access to control & monitoring
- No modifications of existing electrical installation considered
- Anchor-fixed system will be assumed by another contractor.
- Assumption made by Sampol: Structure of the building to support new PV installation. Customer to confirm structural engineering is complying.

PERFORMANCE

- **PV annual production estimation: **2,825 MWh/year 0**

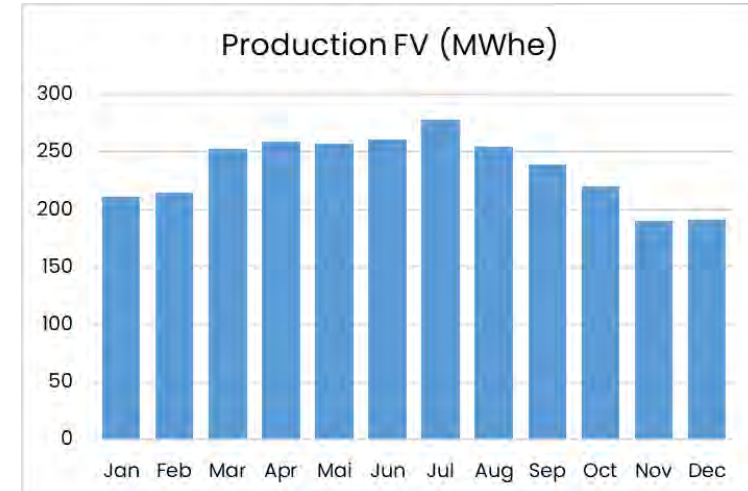

*Number and power of modules and inverters to be defined during detailed engineering respecting nominal and peak power

** The production is estimated for year 0 and based on NREL databases. More accurate estimation need detailed engineering, ambient local conditions and O&M conditions

HYBRID POWER GENERATION

- 1x Natural Gas Genset-Container **Jenbacher J420 GS-N.I**
 - Electrical power on site **1,427** kWe
 - Voltage generation: 480V, 60Hz
 - **Ready** to operate with **H2 up to 10%** per volume without losing any power
 - **Ready** to operate with **H2 up to 20%** per volume. The power operating with 20% H2 per volume is **1,336 kWe** and an electrical efficiency of 41.3%
- The engine can be converted in the future to operate 100% H2

LNG PLANT

- Storage tank – 20,000 USG (5 days autonomy – 1.3 MWe average demand)
- Vaporizers
- Pump skid

BRINE DRYING SYSTEM

- Thermal evaporator to reduce 6,000 Gal blowdown wastewater to 260 Gal concentrated wastewater, producing up to 5,740 Gal distilled water.
- Drying beds included to completely dry the concentrated wastewater.
- Auxiliary Natural Gas heater included to allow regular operation even when the engine is stopped.
- Post treatment to adapt the distilled water to the required characteristics.
- 12,000 Gal raw water buffer tank to increase autonomy.
- 6,000 Gal distilled water tank to allow usage management.

BESS

- LV BESS 750 kWh/ 750 kW

ELECTRICAL SYSTEM

- Control equipment to be located in a Container
- LV Plant SWG cabinets: PV, Genset, BESS, Auxiliary loads and output to Step-up transformer
- Step-Up Transformer 3,000kVA, 0.48/13.2kV installed in the Power Plant area
- 1 x HV cabinet to be installed in the existing Paralleling Switchgear – 15kV

CONTROL SYSTEM

- Distributed Control System, Control and monitoring of grid interconnection by HMI
- Remote operation, SCADA and visualization
- Operation desk to be located on LV & Control room
- BESS integration
- Existing Diesel integration

CIVIL WORKS

- Genset, BESS, LV electrical container, evaporator and water tanks foundations
- HV Cabinet to be installed inside Engine room at existing foundation
- Electrical canalization, considered using existing ones
- The removal of gravel from the Natural Gas Engine and LNG areas is contemplated for its subsequent reuse.
- Stormwater & CES planning included
- Retaining wall, access ladder, and cementation included in the LNG area
- Gas piping canalization to Natural Gas Engine
- Aboveground water piping racks to allow easy maintenance.
- Accessible underground water piping under road crossing to allow free flow.
- Safety Fence considered
- Underground geo survey to be performed to determine any interferences with new pipping and trenches
- Latest available Geotechnical study to be provided by Customer

CONSIDERATIONS

- Customer facilities have Water for Fire Protection System (acc. NFPA 850)
- Stack height up to 10 meters in order to comply with the requirements of Section 123 of the Clean Air Act subject. This stacks height is subject to in situ study during basic engineering
- Permits with government excluded and needs to be managed by Customer. All supporting documentation including professional drawing stamps will be provided by Sampol
- Sampol Civil proposal is based on a bearing load capacity of 1.5 kg/cm² (3,000 psf)

SOLAR PANEL		
Manufacture	LONGI	
Module type	LR7-72HGD-620M	
Cell material	Monocrystalline	
Module construction	Bifacial	
Power (STC)	620	Wp
Open Voltage (Voc)	52.77	V
Short Circuit Current (Isc)	14.85	A
Voltage at Maximum Power (Vmp)	44.33	V
Current at Maximum Power (Imp)	13.99	A
Efficiency	23%	
Dimension	2382 x 1134 x 30	mm
Weight	33.5	kg
J-BOX	IP68	
IEC 61701	Salt mist corrosion	
Materials and Processing Warranty	12	Years
Performance Warranty	30	years

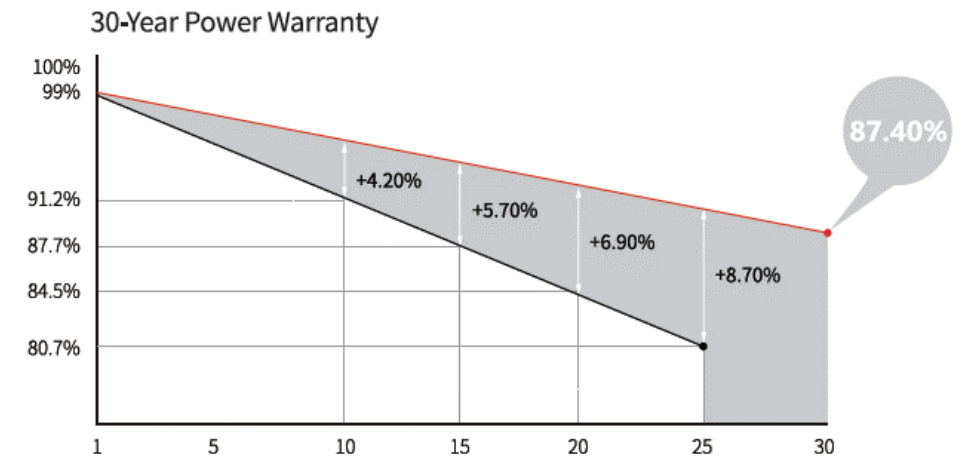
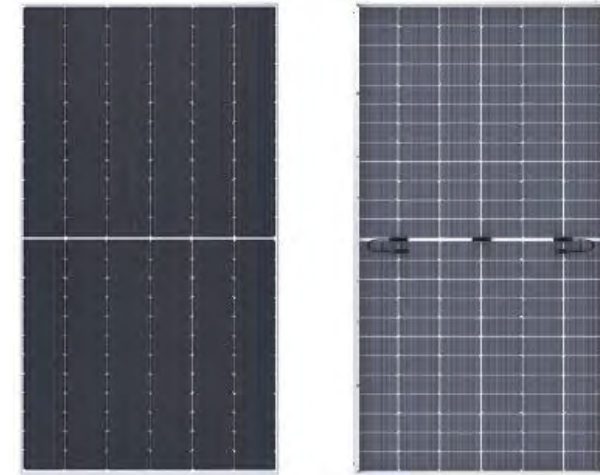

PV INVERTER		
MANUFACTURE		GOODWE
Model		GW100KHT
Power AC output	kVA	100
DC Voltage in	V	1000
Number of MPP trackers		10
Efficiency		98.6%
Dimension	mm	1008 x 678 x 343



BESS	
Power	750 kW
Capacity	750 kWh
Technology	Narada lithium battery
Efficiency	97%
Dimensions	40 ft container (8' w x 8'6 h x 40' l)
Protection	IP54



GENSET “Ready for H2”

Engine Type	JGC 420 GS-N.L	
Fuel	Natural Gas	
Number of cylinder	20	
Mechanical power (on site)⁽ⁱ⁾	1,466	kWm
Rated power (on site)⁽ⁱⁱ⁾	1,427	kWe
Fuel gas consumption⁽ⁱⁱⁱ⁾	11.64	MMBtu_lhv
Nominal Efficiency (on site)	41.8	%
Voltage	480	V
Frequency	60	Hz

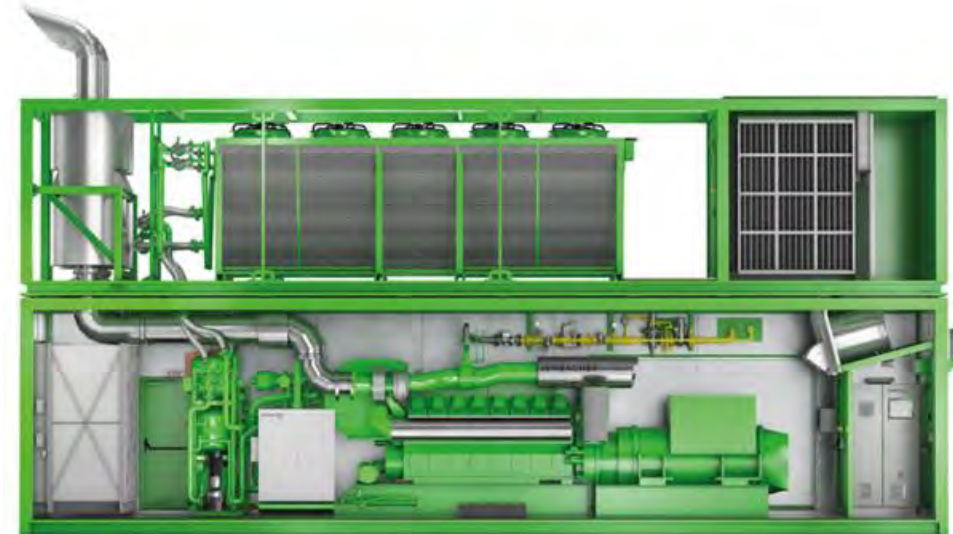

- (i) At nominal speed and standard reference conditions ICFN according to ISO 3046-1, respectively*
- (ii) At p. f. = 1.0 according to IEC 60034-1:2017*
- (iii) According to ISO 3046-1, respectively, with a tolerance of +5 %*

Ready to operate with **H2 up to 10%** per volume without losing any power
Ready to operate with **H2 up to 20%** per volume

BRINE DRYING SYSTEM	
Inlet water	23 m ³ /day
Distilled water	22 m ³ /day
Concentrated wastewater	1 m ³ /day
Thermal consumption	362 kW
Electrical consumption	17 kW
Salt residue in distilled water	<4 ppm
Protection against corrosion	Yes
Auxiliary Natural Gas Heater	400 kW water heater protected against corrosion
Post treatment	pH and salinity control
Raw water buffer tank	12,000 Gal (2 days autonomy)
Threated water tank	6,000 Gal

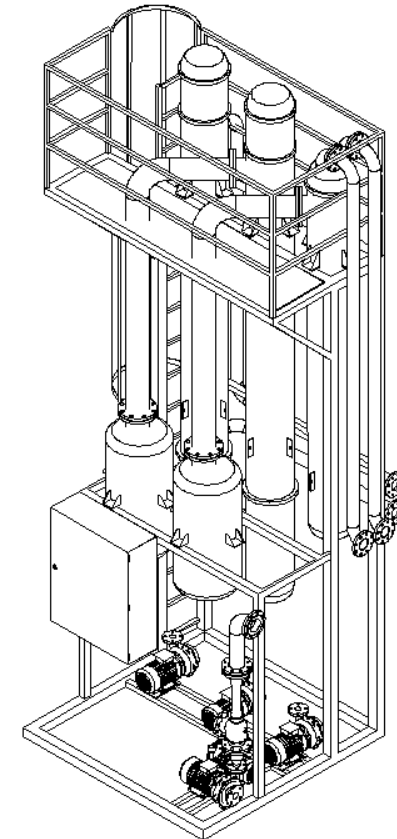



4 SAMPOL ECONOMICAL PROPOSAL

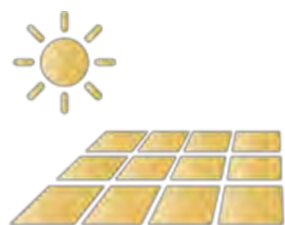

BESS

PV 1,705 kWp	3,074,000 USD
BESS + ELECTRIC & CONTROL INTEGRATION	3,876,000 USD
NATURAL GAS ENGINE	1,922,000 USD
CIVIL WORKS (Excluding LNG Plant and Brine Drying System Civil Works)	1,281,000 USD
LNG PLANT (Including Civil Works)	1,896,000 USD
DIESEL ENGINE INTEGRATION	132,000 USD
BRINE DRYING SYSTEM (Including Civil Works)	2,415,000 USD
PV PLANT + HYBRID POWER PLANT	14,596,000 USD
CONTINGENCY COST (10%)	1,459,600 USD
TOTAL COST	16,055,600 USD



CONSIDERATIONS

- Sampol reserve the right to check price levels and update the proposal cost (if require) prior to signing the contract.
- Economic proposal subject to on-site study. Sampol reserves the right to modify the offer if some of the existing systems cannot be used, and/or changes occur in the final location of the installed equipment
- Sampol included all the permits for the power plant. All Government fees associated with permits are to be paid directly by the owner to PR government.
- IVU, SUT, import duties and/or other local taxes are not included
- Sampol will provide professional engineering drawings stamped by local professional engineers to ensure full compliance with local and federal applicable regulations for SAMPOL scope
- Anchor supply and installation for PV structure estimation around 600,000 USD (this is Econo responsibility).
- **One-year warranty after Substantial Completion is completed**
- ABOVE BUDGETARY PRICES ARE BASED ON T&C SPECIFIED ON THE FIRST SUPPLY AGREEMENT AND CONSTRUCTION AGREEMENT PROVIDED BY SAMPOL. Any additional Liquidated Damages, Insurance, Bonds, Warranty Periods will need to be priced additional based on exact requirements which needs to be provided by Econo.



5 DRAWINGS

PARALLELING SWITCHGEAR - 15kV

TO SUBSTATION
SWITCHGEAR 15kV

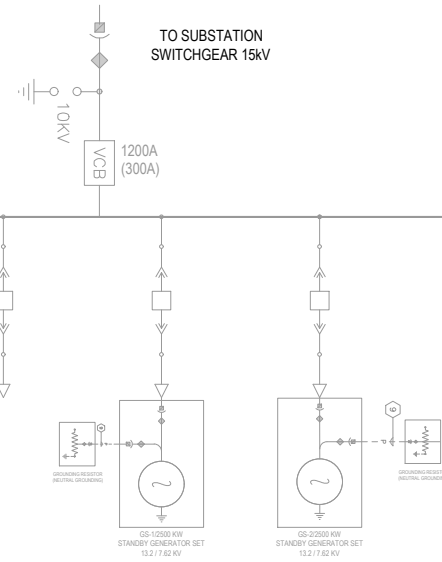

52 L1
600 A

T-LV/HV
3,000 kVA
13,200 V / 480 V

52 - L1
4000 A

ECONO HYBRID POWER PLANT LV SWG (MDB)
4000A, 480V, 3Ph, 4W, 85kAIC

Photovoltaic Plant 1,705 kWp

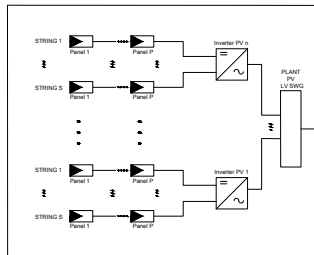

52 - PV
2500 A

52 - AUX
60 A

35 A

52.1.MG1
2500A

52 - BESS 1
1000 A

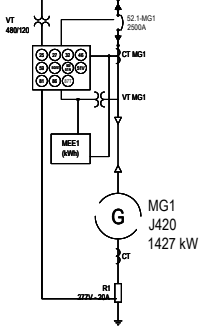
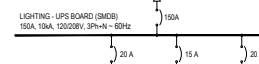
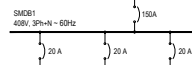

SCOPE OF SUPPLY LIMIT

SAMPOL  OTHERS



Client: HIGH EFFICIENCY HYBRID POWER PLANT
ECONO DISTRIBUTION CENTER

Canóvanas (Puerto Rico)

Project: SINGLE LINE DIAGRAM

Title: ECO-ELE-01-01-E17

Comments: PRELIMINAR DESIGN SUBJECTED TO MODIFICATIONS
DURING THE PROJECT

Scale: N/S
Date: August 2024

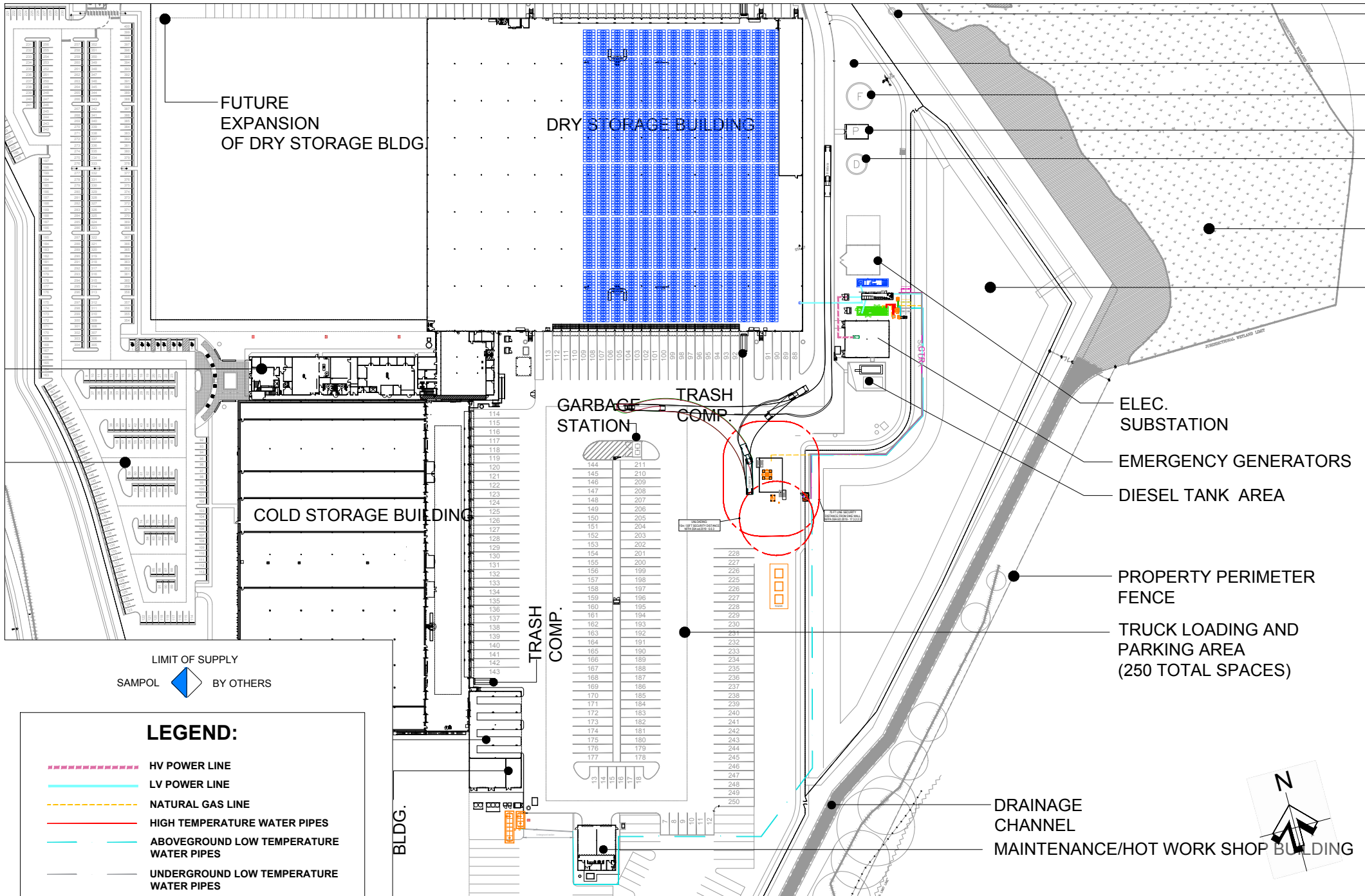

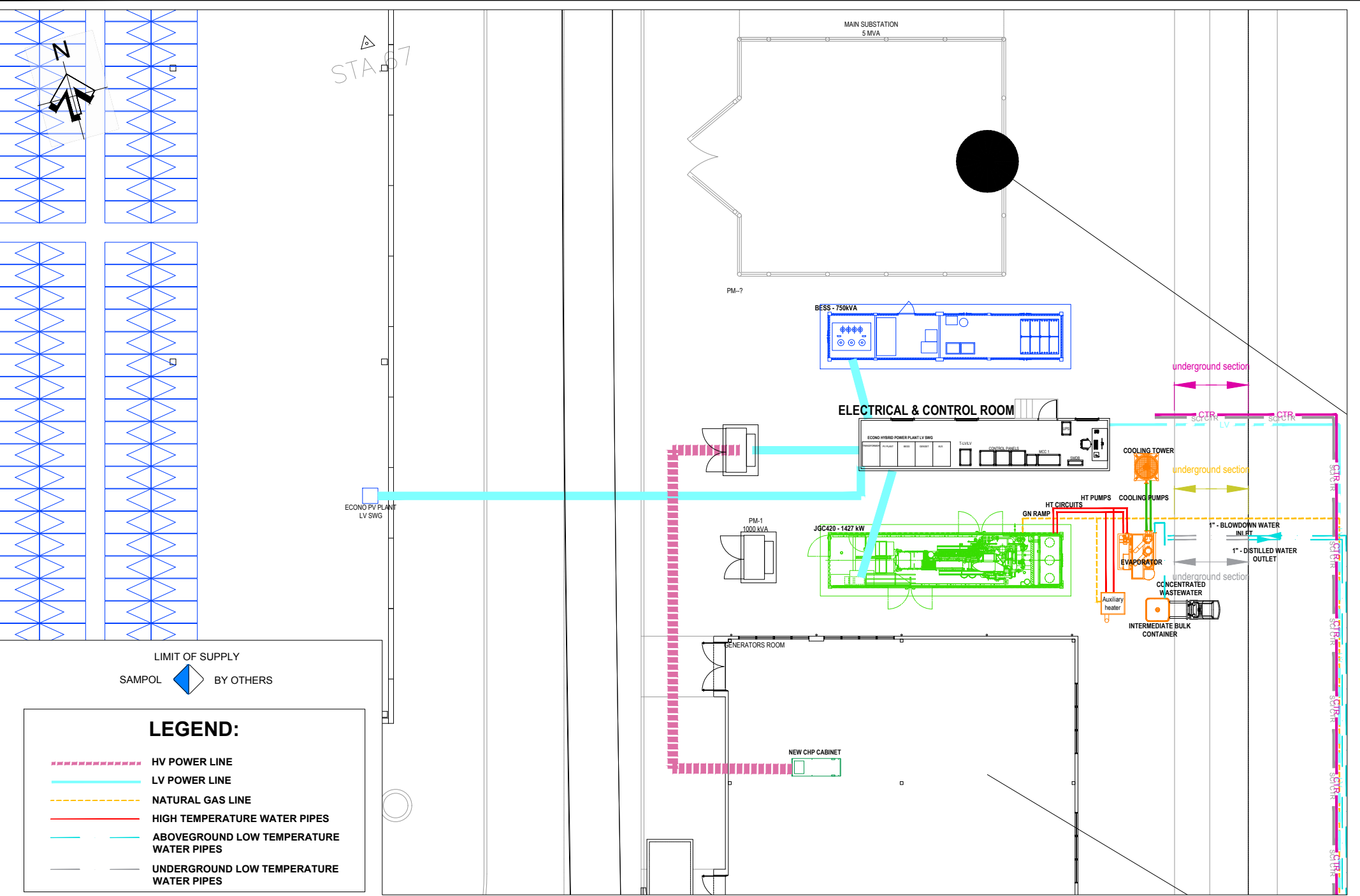

LIMIT OF SUPPLY

SAMPOL BY OTHERS

LEGEND:

- HV POWER LINE
- LV POWER LINE
- NATURAL GAS LINE
- HIGH TEMPERATURE WATER PIPES
- ABOVEGROUND LOW TEMPERATURE WATER PIPES
- UNDERGROUND LOW TEMPERATURE WATER PIPES



2,750 solar panels 620 Wp
PV PLANT 1,705 kWp

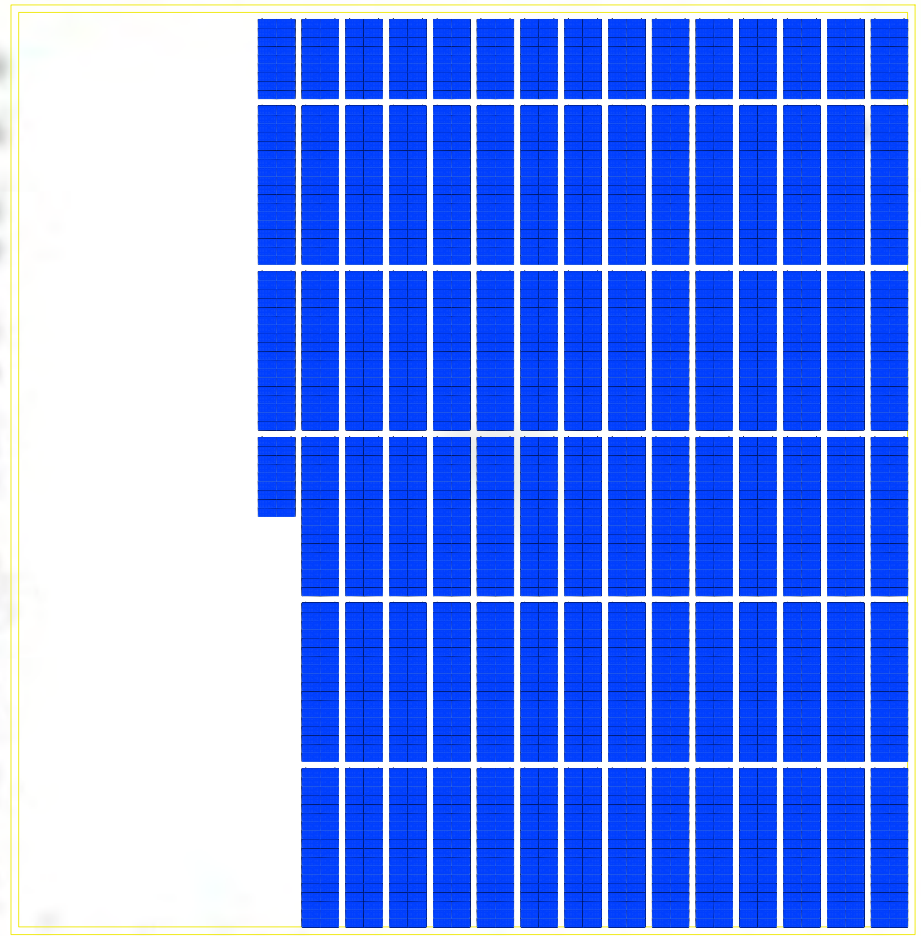

LAYOUT
E: 1:1000

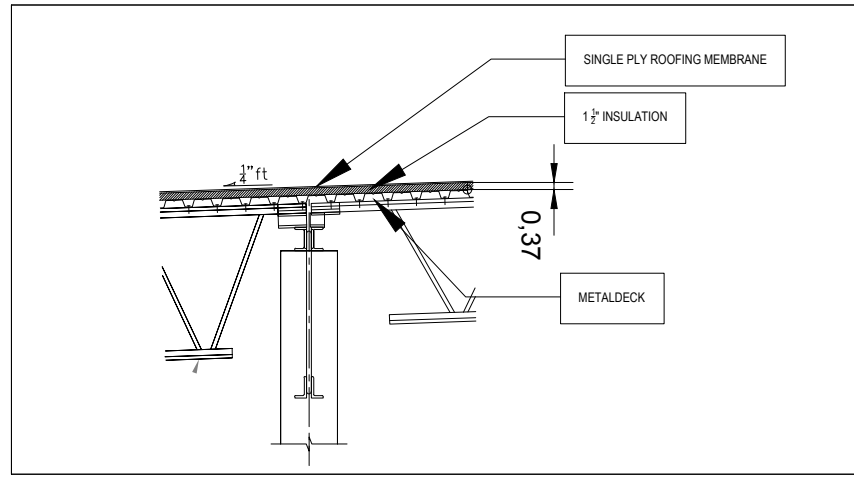

ROOF CONSTRUCTION DETAILS



Roof pictures

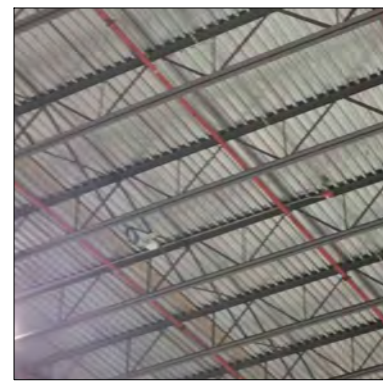

Construction roof support

2,750 solar panels 620 Wp

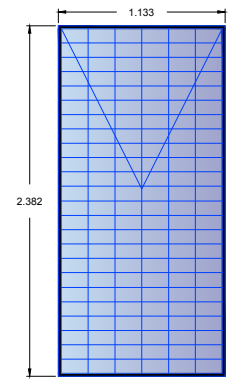

LONGI LR7-72HGD-620M



Client: SOLAR POWER PLANT
1.7 MWp
Canóvanas (Puerto Rico)

Title: PV LAYOUT

Nº drawing: ECO-GEN-02-03-E17

Comments: PRELIMINAR DESIGN SUBJECTED TO MODIFICATIONS
DURING THE PROJECT

Scale: 1:1000
Date: August 2024

EXISTING AMONIA CHILLER PLANT

COOLING TOWERS

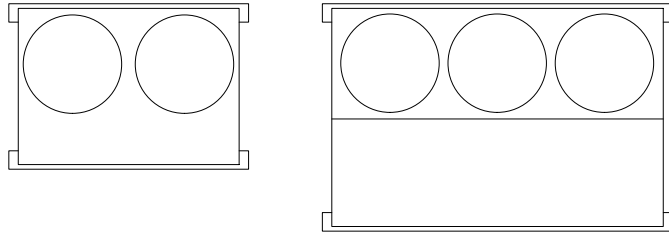

PM5
1500
kVA

PM4

PM3

FUTURES CLIENT COOLING TOWERS

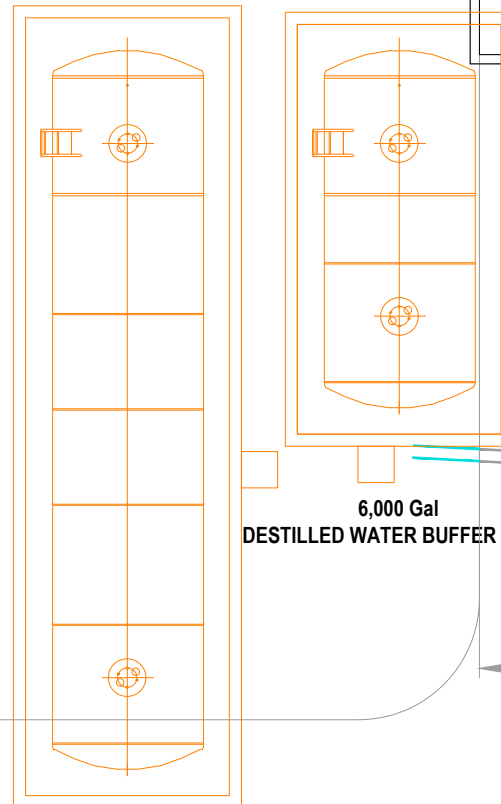

6,000 Gal
DESTILLED WATER BUFFER TANK

12,000 Gal
BLOWDOWN WATER BUFFER TANK

1" - BLOWDOWN WATER
INLET

1" - DISTILLED WATER
OUTLET

Underground section

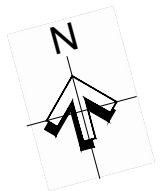

Client: **ECONO**
 Project: HIGH EFFICIENCY HYBRID POWER PLANT
 ECONO DISTRIBUTION CENTER

Canóvanas (Puerto Rico)

Title: LAYOUT AMMONIA CHILLER PLANT

Nº drawing: ECO-GEN-02-04-E17

Comments: PRELIMINAR DESIGN SUBJECTED TO MODIFICATIONS
 DURING THE PROJECT

Scale: 1:125
 Date: August 2024

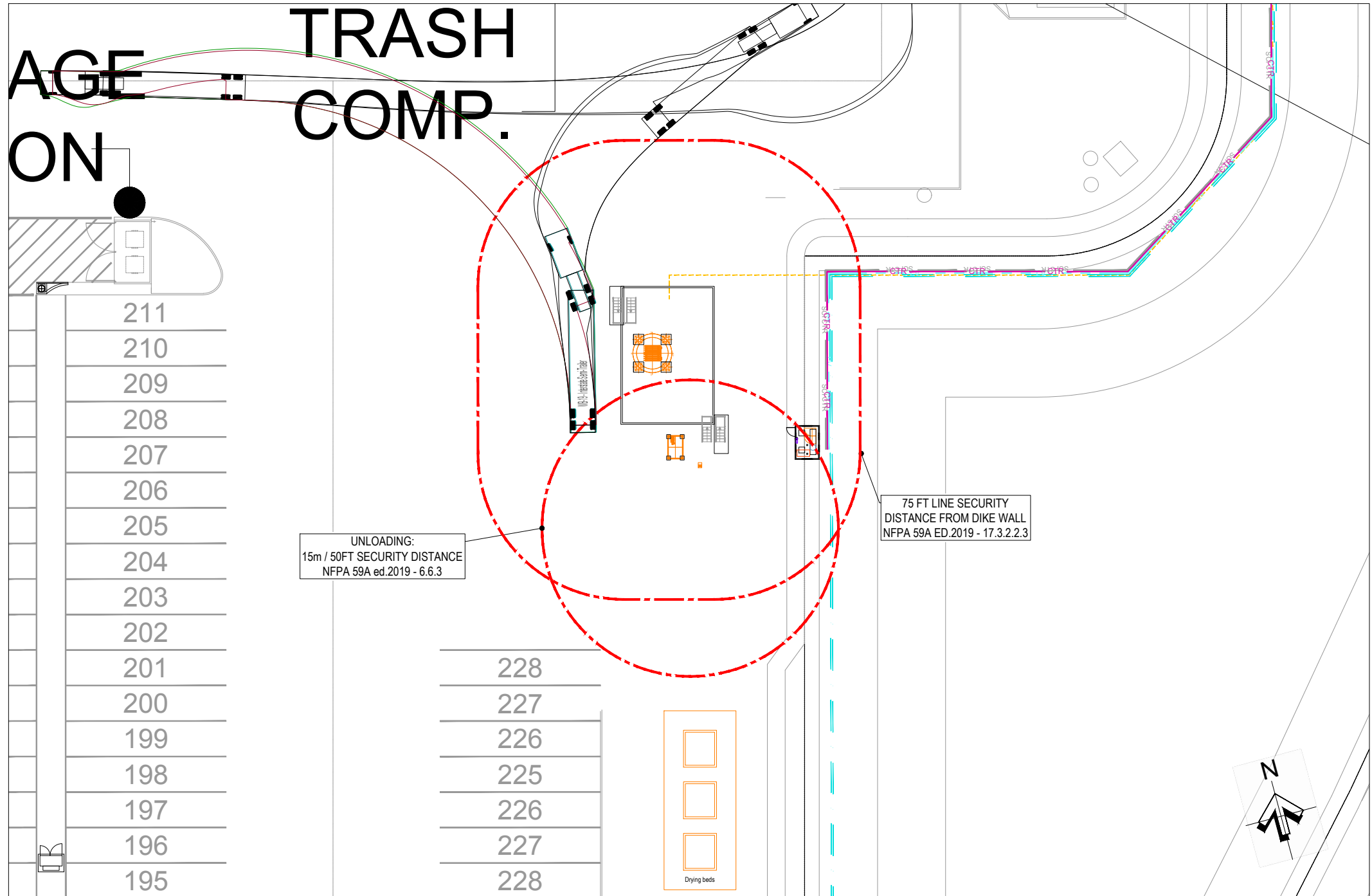

AGE
ON

TRASH
COMP.

211
210
209
208
207
206
205
204
203
202
201
200
199
198
197
196
195

228
227
226
225
226
227
228

UNLOADING:
15m / 50FT SECURITY DISTANCE
NFPA 59A ed.2019 - 6.6.3

75 FT LINE SECURITY
DISTANCE FROM DIKE WALL
NFPA 59A ED.2019 - 17.3.2.2.3

Drying beds

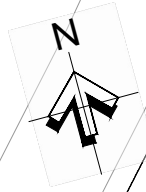

Client: HIGH EFFICIENCY HYBRID POWER PLANT
ECONO DISTRIBUTION CENTER

Title: LNG PLANT LAYOUT

Nº drawing: ECO-GEN-02-05-E17

Comments: PRELIMINAR DESIGN SUBJECTED TO MODIFICATIONS
DURING THE PROJECT

Scale: 1:500
Date: August 2024

Canóvanas (Puerto Rico)



6 SCOPE OF SUPPLY



	ITEMS	SAMPOL CLIENT		NOTES
1 GENERATING SET				
1,1	Jenbacher Genset JGC 420 GS-N.L.	X		1 unit, standard Jenbacher containerized unit
1,2	Flexible connections between engine and external piping	X		
1,3	Generator 480V; 60 Hz	X		
1,4	Flywheel cover	X		
1,5	Container unit	X		
2 MECHANICAL AUXILIARY SYSTEMS				
2.1 NATURAL GAS SYSTEM				
2.1.1	LNG Storage & Regas satellite station	X		20,000 USG tank
2.1.2	Vaporizers	X		2 x 100%
2.1.3	Truck Unloading Skid	X		
2.1.4	Pressure Control Skid	X		
2.1.5	Air compressed system	X		
2.1.6	Engine flow meter	X		1 unit
2.1.7	Piping, valves and instrumentation between LNG regasification plant to engine	X		Natural Gas pipe: up to 130 m from Engine to proposed LNG Storage area.
2.1.8	Engine gas train	X		1 unit
2.1.9	Electrical interconnection of LNG plant	X		
2.2 LUBRICATING OIL SYSTEM				
2.2.1	Lube oil tank inside genset container	X		
2.2.2	Power Plant Lube oil tank		X	If required
2.2.3	Electric Driven Oil Pump	X		1 x genset container
2.2.4	Level switches	X		1 x genset container
2.2.5	Shut-off devices	X		1 x genset container
2.2.6	Pipework between oil tank and module	X		within genset container
2.3 DUAL CIRCUIT COOLING SYSTEM				
2.3.1	Dry coolers for HT & LT	X		
2.3.2	Cooling Pumps	X		1 x genset container
2.3.3	Expansion tanks	X		
2.3.4	Piping, valves and instrumentation	X		
2.4 EXHAUST GAS SYSTEM				
2.4.1	Exhaust gas prevention system	X		
2.4.2	Flexible compensators in turbocharger	X		
2.4.3	Exhaust gas silencer	X		
2.4.4	Exhaust gas ducting	X		
2.4.5	Exhaust gas stack	X		10 mts Considered. Stack height compliance with the requirements of Section 123 of the Clean Air Act is subject to in situ study during basic engineering.
2.4.6	Bellows, spiral wound gaskets, clamps and accessories	X		
2.4.7	Thermal insulation	X		
2.4.8	Selective Catalytic Reduction system or continuous monitoring system		X	If required
2.5 INTAKE AIR SYSTEM				
2.5.1	Charge air fans	X		
2.5.2	Charge air filters	X		
2.5.3	Charge air silencer	X		
2.6 VENTILATION				
2.6.1	Inlet air silencer	X		
2.6.2	Inlet air filters	X		
2.6.3	Inlet air impulsion fan	X		
2.6.4	Outlet air silencer	X		
2.6.5	Ducts and accessories	X		
2.7 FIRE PROTECTION SYSTEM				
2.7.1	Fire pump station		X	
2.7.2	Fire / raw water tank		X	
2.7.3	Hose cabinets		X	
2.7.4	Interconnection with underground fire hydrant system		X	Hybrid Power Plant will be covered by the existing Firefighting System
2.7.5	Fire hydrant system		X	
2.7.6	Portable fire extinguishers	X		
2.7.7	Fire detection and alarm system	X		Located at container-genset, BESS containers and Electrical & Control Container
2.7.8	Gas detection and alarm system	X		Located at container-genset



	ITEMS	SAMPOL CLIENT		NOTES
2.8 PLANT'S AUXILIARY INSTALLATIONS				
2.8.1	City water network within the plant's boundaries	X	X	Client to supply city water for operation and maintenance purposes on boundary limits of Power Plant. Sampol is responsible for connection if needed
2.8.2	Sewage system connection	X	X	Utility by Owner, connection by contractor
2.9 BRINE DRYING SYSTEM				
2.9.1	Engine HT thermal recovery heat exchanger	X		1 unit
2.9.2	Heat recovery brine evaporator	X		1 unit protected against corrosion
2.9.3	Cooling tower for thermal evaporator	X		1 unit protected against corrosion
2.9.4	Piping system, valves and instruments - HT system	X		From genset to thermal evaporator, according to layout. Thermal insulation.
2.9.5	Piping system, valves and instruments - cooling water	X		From thermal evaporator to new cooling tower, according to layout.
2.9.6	Piping system, valves and instruments - blowdown water system	X		From existing ammonia cooling towers to buffer tank and new thermal evaporator, according to layout.
2.9.7	Piping system, valves and instruments - distilled water	X		From new thermal evaporator to existing ammonia cooling towers, according to layout.
2.9.8	Piping system, valves and instruments - concentrated water	X		From thermal evaporator to IBC, according to layout.
2.9.9	Blowdown water and Distilled water distribution pumps	X		Econo shall provide electrical connection to the blowdown water distribution pump within the ammonia cooling towers area.
2.9.10	Blowdown water buffer tank	X		1 x 12,000 Gal, including dike and pit
2.9.11	Distilled water buffer tank	X		1 x 6,000 Gal, including dike and pit
2.9.12	Concentrated water Intermediate Bulk Container	X		1 unit
2.9.13	Drying channel	X		3 units
2.9.14	Auxiliary Natural Gas heater	X		1 unit
3 ENERGY STORAGE				
3.1	LV BESS 750 kW / 750 kWh	X		
4 ELECTRICAL SYSTEMS				
4.1 COMMUNICATIONS AND CONTROL				
4.1.1	Engine control panel	X		1 unit
4.1.2	Master control panel	X		1 unit
4.1.3	Communications rack	X		
4.1.4	Operator workstation	X		Remote Operation Design. Operation room to be located on Low Voltage & Control Room
4.1.5	Control system integration	X		PV, BESS, Diesel Engines and Gas Genset
4.1.6	SCADA	X		
4.1.7	Control system cables and transmission lines	X		
4.2 HIGH VOLTAGE SYSTEM				
4.2.1	Possible modifications to 38kV client's switchgear according to LUMA requirements		X	If required
4.2.2	Changes to LUMA distribution network and interconnection between Power Plant and LUMA control utilities (optical fiber line and equipment)		X	If required
4.2.3	Remotely operated control equipment LUMA		X	If required
4.3 MEDIUM VOLTAGE SYSTEM				
4.3.1	Step-up Transformer, 3,000kVA, 13.2kV/0.48kV	X		1 Unit.
4.3.2	New powerline between Step Up transformer and Paralleling Switchgear - 15kV	X	X	Use of existing canalization
4.3.3	New Cabinets at Paralleling SWG 15kV	X		1 Unit to be installed in the existing Paralleling Switchgear - 15kV.
4.3 LOW VOLTAGE SYSTEM				
4.3.1	Low Voltage Switchgear 480 V/ 4000A	X		According to SLD. Installation in container
4.3.2	Genset motor control center 480 V	X		
4.3.3	Low Voltage Transformer 480/208 V 50KVA	X		1 Unit
4.3.4	Auxiliary low voltage cabinet 220 V	X		
4.3.5	Lighting distribution board	X		
4.3.6	UPS, including batteries	X		
4.3.7	UPS distribution board	X		
4.3.8	LV transmission lines	X		Within Power Plant



ITEMS		SAMPOL CLIENT		NOTES
5 PV PLANT 1,785 kWp				
5.1 MAIN EQUIPMENT PHOTOVOLTAIC PLANT				
5.1.1	Monocrystalline solar panels of 620 Wp or similar	X		Model as a reference and subject to change as per final design to meet 1,705 kWp electrical power installed
5.1.2	Galvanized steel structure to accommodate solar panels	X		Steel support structure for coplanar installation with screws and steel anchors (Final design subject to modifications according to the constructive solution of the roof). It is considered that the roof can support the weight of the photovoltaic plant. Customer to confirm structural engineering is compatible with proposed design
5.1.3	Multi-String Inverter of 100 kVA	X		Power and number of inverters will be defined during detailed engineering to meet 1,500 kVA electrical power installed
5.2 DC INSTALLATION				
5.2.1	Electrical connection of solar panels	X		
5.2.2	Supply and installation, cable pulling and connection of string and inverters	X		
5.2.3	Rapid Shutdown devices	X		
5.2.4	Cable trays and tubes	X		
5.3 AC INSTALLATION				
5.3.1	General Low Voltage Switchgear 480 V to connect Photovoltaic	X		Located next to the PV plant
5.3.2	LV Cables from PV Plant LV SWG to New General LV SWG, conduits and cable trays	X	X	It si consider to use existing canalization. Cables included
5.3.3	Supply and installation, cable pulling and connection of equipment	X		
5.3.4	Cable trays and tubes	X		
5.4 MECHANICAL INSTALLATION				
5.4.1	Solar panels installation	X		
5.4.2	Structure installation	X		
5.4.3	Inverters installation	X		
6 CIVIL WORKS				
6.1	Access ways from the road to the Power Plant and LNG Satellite plant		X	
6.2	Demolitions and existing equipments dismantling		X	If required
6.3	Site clearing & Top soil removal		X	
6.4	Excavation, levelling, and filling (earthworks)	X		
6.5	Gravel		X	The removal of gravel from the POWER PLANT and LNG areas is contemplated for its subsequent reuse
6.6	Equipment foundations	X		
6.7	Stormwater & CES	X		plan during construction
6.8	Soundproofing measures	X		According to applicable regulations
6.9	Equipment access and maintenance structures	X		
6.10	Trenches, gutters, galleries, sewage pipes, or racks for electrical transmission lines, waterways, gas pipes and oil pipes	X		No conduits are contemplated for the photovoltaic plant or for the Transformer-Substation interconnection, it is considered the use of existing one. Pipe banks are only in the Motor - LV Container interconnections; LV Container - Transformer; LV Container - LNG Area; LV Containter - Brine drying system. Underground trenches for distilled water and blowdown water system from existing ammonia chiller plant cooling towers to brine drying system. Restoration of pavement considered for sections whose trenches traverse paved areas, according to layout. Aboveground pipe racks for the piping system within the brine drying plant area.
6.11	Warehouse & workshop		X	Space provided by client. To be conditioned, furnished and equiped by SAMPOL



	ITEMS	SAMPOL CLIENT		NOTES
7	ENGINEERING, WORKS MANAGEMENT, PERMITS AND TAXES			
7.1	Topographic assessment		X	If required
7.2	Geotechnical assessment		X	If required
7.3	Ambient Air & Water Quality Analysis		X	If required
7.4	Seismic & Wind Speed Survey		X	If required
7.5	Environmental assessment: noise, polluting emissions, effluents, ...		X	If required
7.6	Project & Engineering management for equipment supplied by Sampol	X		
7.7	Basic Engineering - Civil Works	X		
7.8	Basic Engineering - Mechanical	X		
7.9	Basic Engineering - Electrical	X		
7.10	Basic Engineering - Control	X		
7.11	Basic Engineering - Engine	X		
7.12	Detailed Engineering - Engine	X		
7.13	Detailed Engineering - Civil Works	X		
7.14	Detailed Engineering - Mechanical	X		
7.15	Detailed Engineering - Electrical	X		
7.16	Detailed Engineering - Control	X		
7.17	Health and Safety, and Environmental Procedures	X		
7.18	Quality Procedures	X		
7.19	Equipment certificates	X		
7.20	Construction permits, air permits and other permits	X	X	<ul style="list-style-type: none"> Sampol included all the permits for power plant All Government fees associated with permits to be paid directly by owner to PR government. Sampol will provide professional engineering drawing stamped by local professional engineer to ensure full compliance with local and federal applicable regulations for SAMPOL scope
7.21	Fondo del Seguro del Estado de Puerto Rico	X		
7.22	Sales, IVU and local taxes		X	
8	WORKS COMPLETION MANAGEMENT			
8.1	Anchoring Roof Installation works		X	Sampol to provide the installation / anchoring requirements. The anchoring solution needs to be developed by roof contractor. Econo and roof contractor will be responsible for the installation of anchoring system and will provide the warranty.
8.2	Panels installation	X		Sampol is only hold responsible if the crew is damaging the roof during the installation of the panels and or providing the wrong anchoring requirements.
8.3	Works' direction and supervision	X		
8.5	Appropriate area for the storage of equipment and material		X	
8.6	Appropriate area for works related to prefabrication and preparation of equipment		X	
8.7	Right of way		X	
8.8	Machinery and construction means	X		
8.9	Site offices and toilets		X	
8.10	Security Power Plant area		X	Covered by client security
8.11	Overnight surveillance of the plant plot		X	Covered by client security
8.12	Site electrical supply during construction		X	Utility by Owner, connection by Sampol
8.13	Site potable water supply during construction		X	Utility by Owner, connection by Sampol
8.14	ADSL or GPRS internet supply		X	
8.15	Construction fully comprehensive insurance	X		Not according to FM GLOBAL requirements if needed
8.16	Civil liability insurance	X		Not according to FM GLOBAL requirements if needed
8.17	Disposal of works waste during construction	X		
8.18	Disposal of preexisting waste on site		X	

HIGH EFFICIENCY HYBRID POWER PLANT ECONO DISTRIBUTION CENTER (CANÓVANAS, PUERTO RICO)

SCOPE OF SUPPLY (08/2024)



ITEMS		SAMPOL CLIENT		NOTES
9 TESTS AND COMMISSIONING				
9.1	PreCommissioning & Commissioning supervision	X		
9.2	Factory tests	X		
9.3	Travel costs for Owner's attendance to factory test		X	
9.4	On-site tests	X		
9.5	Oil fill for the engine and MV transformer	X		
9.6	Spare parts for commissioning	X		Only for main equipment provided by SAMPOL
9.7	Electricity required for tests		X	
9.8	Fuel required for tests		X	
9.9	Disposal of dangerous and non-dangerous wastes during tests	X		
9.10	Operators' training course	X		For equipment supplied by Sampol
10 LOGISTICS AND SHIPPING				
10.1	Shipping of equipment to site (land, sea and air)	X		
10.2	Port costs (loading, unloading, crantage, etc.)	X		
10.3	Management of customs clearance process	X		
10.4	Customs costs (customs dispatch, stamp charges...)	X		
10.5	Import duties	X	X	ECONO shall be solely responsible for the management of the customs clearance process for all Equipment. ECONO shall pay the sales and uses taxes ("SUT"), import duties, and any other taxes related to the importation or customs clearance ECONO shall serve as the Importer of Record of the Equipment and responsible for the import management of the Equipment
10.6	Equipment unloading on site	X		



7 SCHEDULE

ECONO HYBRID POWER PLANT

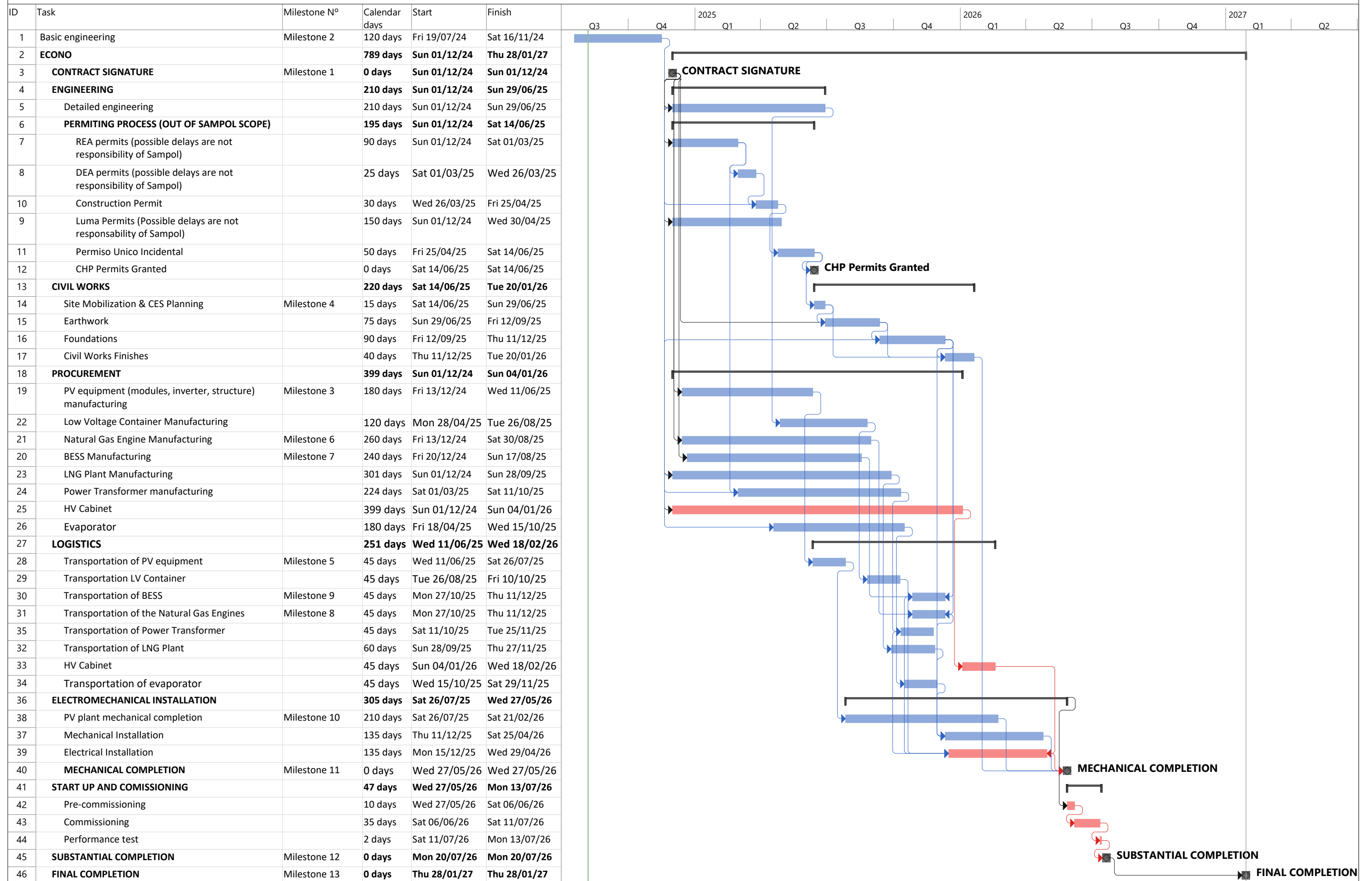

PRELIMINARY

  @ingSampol

 [linkedin.com/company/sampol](https://www.linkedin.com/company/sampol)



SAMPOL

CONTACT

Gremio Boneteros, 48, Palma de Mallorca | 07009 | Spain

www.sampol.com

Appendix 2:
Site location map

Appendix 2 Site Location Map

Econo Energy Project

Project ID: IPGM-00375

Address: State Road PR-3, Int. PR 9959, Km. 15.21 Bo.
Canovanillas, Canóvanas, PR. 00729

Coordinates: 18.373613° -65.906549° 



Source: Image from Google Earth Pro, image date 6/15/2023.

Appendix 3:
Photos of Existing Site Conditions

Econo Energy Project

Project ID: IPGM-00375

Address: State Road PR-3, Int. PR 9959, Km. 15.21 Bo. Canovanillas, Canóvanas, PR. 00729

Coordinates: 18.373613° -65.906549°

Photos of existing site conditions



Rooftop where PV panels will be installed



Photo showing the areas where Liquefied Natural Gas (LNG) tank and equipment and drying beds. will be installed



Area for control room, Gas-powered generator, Battery Energy Storage System, evaporator, buffer tank and cooling tower

Utilities area showing area where the new equipment and control room will be located.



Area for control room, Gas-powered generator, Battery Energy Storage System, evaporator, buffer tank and cooling tower

Ground-level photo showing the area next to the building where the existing emergency-power generator units are located and where new equipment will be located.



Ground-level photo showing the area where the Photo showing the area where Liquefied Natural Gas (LNG) tank and its equipment will be installed.

Appendix 4:
Historical imagery from Google Earth (4A-4C)

Appendix 4a

Historical imagery – Google Earth Pro

Econo Energy Project

Project ID: IPGM-00375

Address: State Road PR-3, Int. PR 9959, Km. 15.21 Bo.

Canovanillas, Canóvanas, PR. 00729

Coordinates: 18.373613° -65.906549°

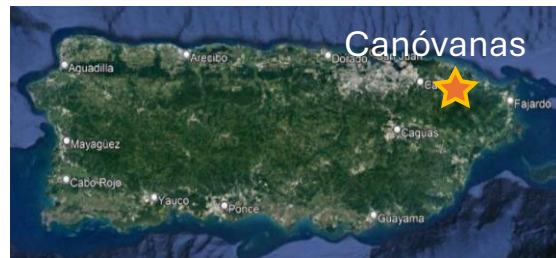

Imagery
Date:
4/28/2018



Scale

Source: Google Earth

Spatial reference: unknown

Appendix 4b

Historical imagery – Google Earth Pro

Econo Energy Project

Project ID: IPGM-00375

Address: State Road PR-3, Int. PR 9959, Km. 15.21 Bo.

Canovanillas, Canóvanas, PR. 00729

Coordinates: 18.373613° -65.906549°

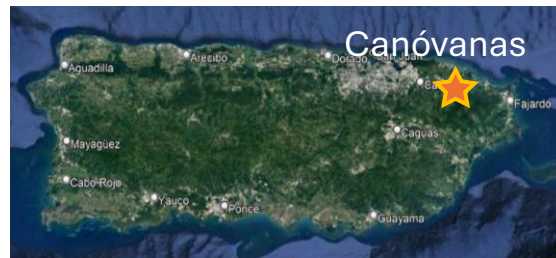

Imagery
Date:
1/26/2019



Source: Google Earth

Spatial reference: unknown

Appendix 4c

Historical imagery – Google Earth Pro

Econo Energy Project

Project ID: IPGM-00375

Address: State Road PR-3, Int. PR 9959, Km. 15.21 Bo. Canovanillas, Canóvanas, PR. 00729

Coordinates: 18.373613° -65.906549°



Imagery Date: 5/3/2021



Scale

Source: Google Earth

Spatial reference: unknown

Appendix 5:
Topographic Map

Appendix 5

Topographic Map (Detail)

Econo Energy Project

Project ID: IPGM-00375

Address: State Road PR-3, Int. PR 9959, Km. 15.21 Bo. Canovanillas, Canóvanas, PR. 00729

Coordinates: 18.373613° -65.906549°

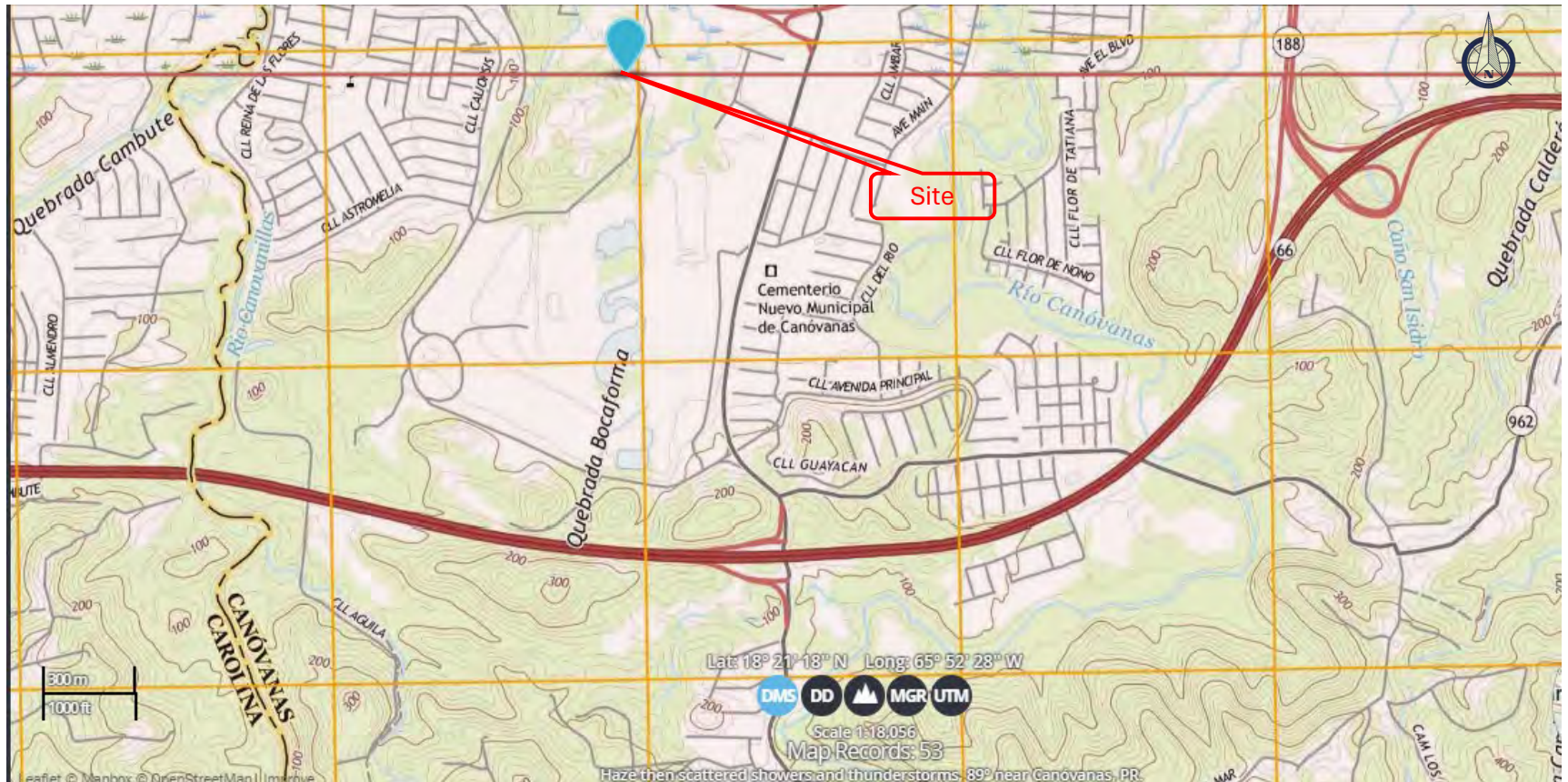

US Department of the Interior, US Geological Survey
Gurabo Quadrangle, 2018
Datum NAD83, Projection: TM

Source: <https://ngmdb.usgs.gov/topoview/> , accessed 6/1/2024

Appendix 6:
Flood Insurance Rate Map

Appendix 6

Flood Insurance Rate Map (FIRM)

Econo Energy Project

Project ID: IPGM-00375

Address: State Road PR-3, Int. PR 9959, Km. 15.21 Bo. Canovanillas, Canóvanas, PR. 00729

Coordinates: 18.373613° -65.906549°

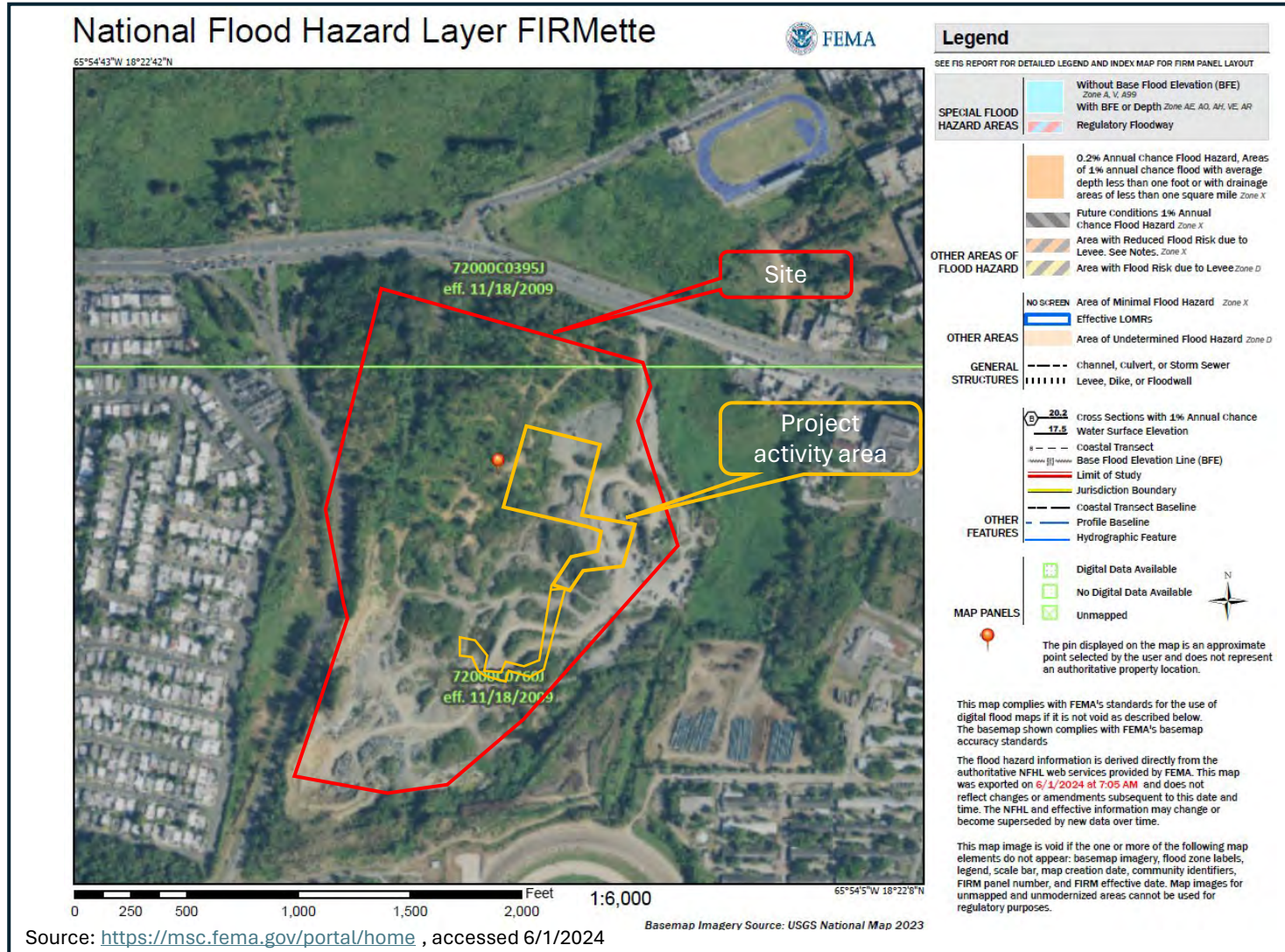
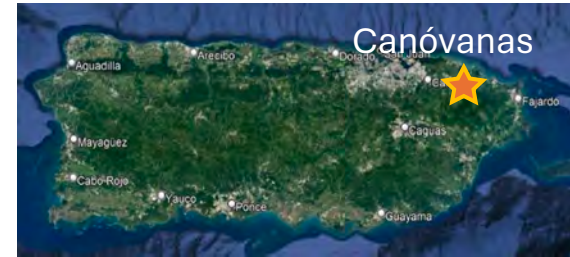

Appendix 7:
Advisory Base Flood Elevation Map

Appendix 7

Advisory Base Flood Elevation (ABFE) Map

Econo Energy Project

Project ID: IPGM-00375

Address: State Road PR-3, Int. PR 9959, Km. 15.21 Bo. Canovanillas, Canóvanas, PR. 00729

Coordinates: 18.373613° -65.906549°

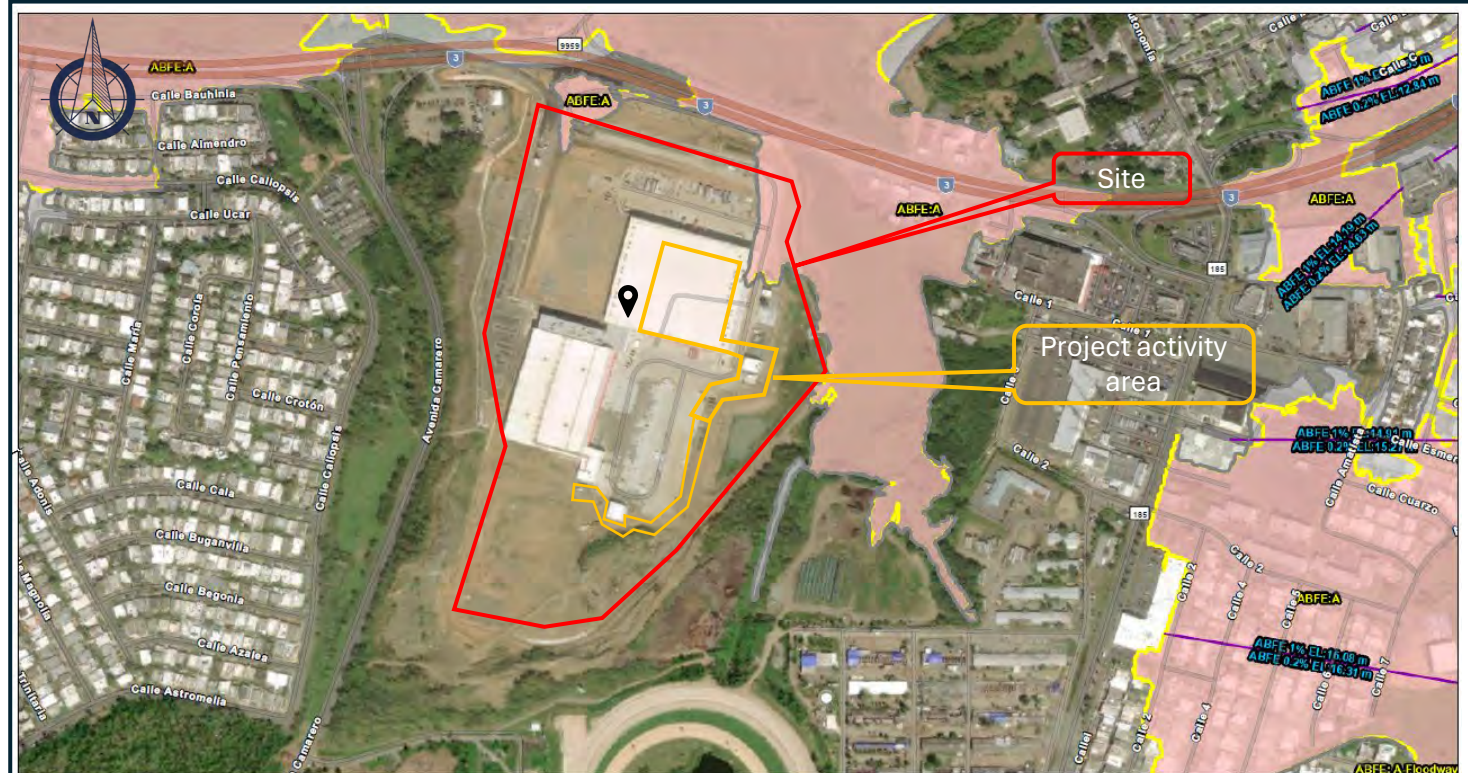

5/19/2024, 5:06:32 PM

Flood Hazard Area (zoom in to make visible) Flood Hazard Extent

- A
- 0.2% Annual Chance Flood Zone
- A-Floodway
- Zone/BFE Boundary
- 1% Annual Chance Flood
- 0.2% Annual Chance Flood
- Advisory Base Flood Elevation (zoom in to make visible)

1:4,514

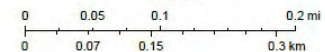

FEMA, Source: Esri, Maxar, Earthstar Geographics, and the GIS User Community, Esri Community Maps Contributors, Esri, TomTom, Garmin, Foursquare, SafeGraph, GeoTechnologies, Inc, METI/ANASA, USGS, NPS, US Census Bureau, USFWS

ArcGIS Web AppBuilder

FEMA | Source: Esri, Maxar, Earthstar Geographics, and the GIS User Community | Esri Community Maps Contributors, Esri, TomTom, Garmin, Foursquare, SafeGraph, GeoTechnologies, Inc, METI/ANASA, USGS, NPS, US Census Bureau, USFWS |

Appendix 8:
Wetland Map

Appendix 8

Wetland Map

Econo Energy Project

Project ID: IPGM-00375

Address: State Road PR-3, Int. PR 9959, Km. 15.21 Bo.









Canovanillas, Canóvanas, PR. 00729

Coordinates: 18.373613° -65.906549° 



May 19, 2024

Wetlands

- | | | |
|--|---|--|
|  Estuarine and Marine Deepwater |  Freshwater Emergent Wetland |  Lake |
|  Estuarine and Marine Wetland |  Freshwater Forested/Shrub Wetland |  Other |
| |  Freshwater Pond |  Riverine |

This map is for general reference only. The US Fish and Wildlife Service is not responsible for the accuracy or currentness of the base data shown on this map. All wetlands related data should be used in accordance with the layer metadata found on the Wetlands Mapper web site.

Source: <https://www.fws.gov/program/national-wetlands-inventory/wetlands-mapper>

National Wetlands Inventory (NWI)
This page was produced by the NWI mapper

Appendix 9:

IPaC Species list (06/01/2024) and Consistency letter
(06/02/2024)



United States Department of the Interior



FISH AND WILDLIFE SERVICE
Caribbean Ecological Services Field Office
Post Office Box 491
Boqueron, PR 00622-0491
Phone: (939) 320-3135 Fax: (787) 851-7440
Email Address: CARIBBEAN_ES@FWS.GOV

In Reply Refer To:
Project code: 2024-0098241
Project Name: IPGM-00375

06/02/2024 19:23:45 UTC

Subject: Consistency letter for the project named 'IPGM-00375' for specified threatened and endangered species, that may occur in your proposed project location, pursuant to the IPaC determination key titled Caribbean Determination Key (DKey).

Dear Applicant:

Thank you for using the assisted evaluation keys in IPaC. This letter is provided pursuant to the Service's authority under the Endangered Species Act of 1973, as amended (ESA) (87 Stat. 884; 16 U.S.C. 1531et seq.). On June 02, 2024, Hector Sanchez used the Caribbean DKey; dated April 03, 2024, in the U.S. Fish and Wildlife Service's online [IPaC application](#) to evaluate potential impacts to federally listed species, from a project named 'IPGM-00375'. The project is located in Canóvanas County, Puerto Rico (shown below).

The approximate location of the project can be viewed in Google Maps: <https://www.google.com/maps/@18.3727594,-65.9063982006751,14z>



The following description was provided for the project 'IPGM-00375':

The project consists of the construction of a Hybrid Power Plant for the Econo supermarket chain's distribution center in Canóvanas, Puerto Rico.

Based on your answers and the assistance of the Service's Caribbean DKey, you determined the proposed Action will have "No Effect" on the following species:

Species	Listing Status	Determination
Puerto Rican Boa (<i>Chilabothrus inornatus</i>)	Endangered	No effect

Thank you for informing the Service of your "No Effect" determination(s) for this project. No further consultation/coordination for this project is required for these species. However, be aware that reinitiation of consultation may be necessary if later modifications are made to the project so that it no longer meets the criteria or outcome described above, or if new information reveals effects of the action that could affect listed species or critical habitat in a manner or to an extent not previously considered, or if a new species is listed.

This letter serves as documentation of your consideration of the federally listed species as required under section 7 of the ESA. However, effects to the other federally listed species or critical habitat as listed below from the "IPaC print-out for the project" (see below) should be considered as part of your ESA review for the project.

The Service will notify you within 30 calendar days if we determine that this proposed Action does not meet the criteria for a "No Effect" (NE) determination for Federally listed species in the Caribbean. If we do not notify you within that timeframe, you may proceed with the Action under the terms of the NE concurrence provided here. This verification period allows the Caribbean Ecological Services Field Office to apply local knowledge to evaluate the Action, as we may identify a small subset of actions having unanticipated impacts. In such instances, the Caribbean Ecological Services Field Office may request additional information to verify the effects determination reached through the DKey.

Note: Projects located within the range of the Puerto Rican boa or the Virgin Islands tree boa might encounter these species during project activities. **This letter does not provide take to handle or move these species.** If relocation of the species is needed, please contact either the Puerto Rico Department of Natural Resources (DNER) at 787-724-5700, 787-230-5550, or 787-771-1124 for projects in Puerto Rico, or the Virgin Islands Department of Planning and Natural Resources, Division of Fish and Wildlife (DFW) at 340-775-6762 for projects in the Virgin Islands. Otherwise, contact the Caribbean Ecological Services Field Office (caribbean_es@fws.gov) to determine whether the consultation needs to be reinitiated.

If the proposed project is located within species range where a DKey has not been developed for those species, please follow the established guidance for initiating section 7 consultation Caribbean Ecological Services Field Office.

We appreciate your interest in protecting endangered species and their habitats. It is the Service's mission to work with others to conserve, protect, and enhance fish, wildlife, and plants and their

habitats for the continuing benefit of our people. If you have any questions or require additional information, please contact our office at Caribbean_es@fws.gov.

Action Description

You provided to IPaC the following name and description for the subject Action.

1. Name

IPGM-00375

2. Description

The following description was provided for the project 'IPGM-00375':

The project consists of the construction of a Hybrid Power Plant for the Econo supermarket chain's distribution center in Canóvanas, Puerto Rico.

The approximate location of the project can be viewed in Google Maps: <https://www.google.com/maps/@18.3727594,-65.9063982006751,14z>



QUALIFICATION INTERVIEW

1. Is the proposed project an EPA Multi-Sector General Permit (MSGP) renewal for an existing project? ([MSGP Fact Sheet](#))

No

2. Is the proposed project within an urban developed area? (i.e., cities, downtowns, shopping malls etc.)

Note: Urban and developed areas has one or more of the following characteristics: Presence of existing buildings, residential areas, and commercial establishments. Well-established infrastructure including roads, utilities, and urban facilities. High population density. Established neighborhoods and urban amenities ("urbanizaciones"). Developed landscape with paved surfaces, parking lots, and industrial areas. Signs of human activity and urbanization, such as shopping centers and recreational facilities. Location within the boundaries of a city or town ("casco urbano"). High concentration of built-up structures and limited open spaces. Aerial imagery might be requested to the applicant. .

No

3. Does the proposed project consist of rehabilitation or demolition of existing single-family homes and buildings?

No

4. Does the proposed project consist of improvements to existing facilities?

Note: Examples of facilities are occupied single family homes, and buildings; existing recreational facilities, including the installation of roofs to existing basketball courts, etc.

Yes

5. [Hidden Semantic] Does the proposed project intersect the Puerto Rican boa area of influence?

Automatically answered

Yes

IPAC USER CONTACT INFORMATION

Agency: SCA Consulting Engr
Name: Hector Sanchez
Address: PO Box 2485
City: Guaynabo
State: PR
Zip: 00970
Email: hsanchez@scaeng.com
Phone: 7875020001

LEAD AGENCY CONTACT INFORMATION

Lead Agency: Department of Housing and Urban Development



United States Department of the Interior



FISH AND WILDLIFE SERVICE
Caribbean Ecological Services Field Office
Post Office Box 491
Boqueron, PR 00622-0491
Phone: (939) 320-3135 Fax: (787) 851-7440
Email Address: CARIBBEAN_ES@FWS.GOV

In Reply Refer To:
Project Code: 2024-0098241
Project Name: IPGM-00375

06/01/2024 02:12:24 UTC

Subject: List of threatened and endangered species that may occur in your proposed project location or may be affected by your proposed project

To Whom It May Concern:

THE FOLLOWING SPECIES LIST IS NOT A SECTION 7 CONSULTATION. PLEASE CONTACT OUR OFFICE TO COMPLETE THE CONSULTATION PROCESS

The purpose of the Endangered Species Act (Act) is to provide a means whereby threatened, and endangered species and the ecosystems upon which they depend may be conserved. Under sections 7(a)(1) and 7(a)(2) of the Act and its implementing regulations (50 CFR 402 et seq.), Federal agencies are required to utilize their authorities to carry out programs for the conservation of threatened and endangered species and to determine whether projects may affect those species and/or their designated critical habitat.

Federal agencies are required to "request of the Secretary of Interior information whether any species which is listed or proposed to be listed may be present in the area of a proposed action". The enclosed species list provides information to assist with the U.S. Fish and Wildlife Service (Service) consultation process under section 7 of the Act. However, **the enclosed species list does not complete the required consultation process.** The species list identifies threatened, endangered, proposed and candidate species, as well as proposed and designated critical habitats, that may occur within the boundary of your proposed project and/or may be affected by your proposed project. A discussion between the Federal agency and the Service should include what types of listed species may occur in the proposed action area and what effect the proposed action may have on those species. This process initiates informal consultation.

Once a species list is obtained for the proposed project, an effect determination for endangered and threatened species should be made. The applicant could make an effect determination by using available keys on IPaC for specific species. For species with no determination keys, the applicant should request concurrence from the Service by sending a project package

to caribbean_es@fws.gov. To obtain guidance for completing this process and the minimum requirements for project packages, please visit:

<https://www.fws.gov/sites/default/files/documents/consultation-under-section-7-of-the-endangered-species-act-with-the-caribbean-ecological%20Services-field-office-template-letter.pdf>

When a federal agency, after discussions with the Service, determines that the proposed action is not likely to adversely affect any listed species, or adversely modify any designated critical habitat, and the Service concurs, the informal consultation is complete, and the proposed project moves ahead. If the proposed action is suspected to affect a listed species or modify designated critical habitat, the Federal agency may then prepare a Biological Assessment (B.A.) to assist in its determination of the project's effects on species and their habitat. However, a B.A. is required for construction projects (or other undertakings having similar physical impacts) that are major Federal actions significantly affecting the quality of the human environment as defined in the National Environmental Policy Act (42 U.S.C. 4332(2) (c)). For projects other than major construction activities, the Service suggests that a biological evaluation similar to a B.A. where the agency provides the Service with an evaluation on the likely effects of the action to determine whether the project may affect listed or proposed species and/or designated or proposed critical habitat. Recommended contents of a B.A. are described at 50 CFR 402.12.

If a federal agency determines, based on its B.A. or biological evaluation, that listed species and/or designated critical habitat may be affected by the proposed project, the agency is required to further consult with the Service pursuant to 50 CFR 402. In addition, the Service recommends that candidate species, proposed species, and proposed critical habitat be addressed within the consultation process. More information on the regulations and procedures for section 7 consultation, including the role of permit or license applicants, can be found in the "Endangered Species Consultation Handbook" at:

<https://www.fws.gov/sites/default/files/documents/endangered-species-consultation-handbook.pdf>

New information based on updated surveys, changes in the abundance and distribution of species, changed habitat conditions, or other factors could change this list. Please feel free to contact us if you need more current information or assistance regarding the potential impacts to federally proposed, listed, and candidate species.

This list is provided pursuant to Section 7 of the Endangered Species Act and fulfills the requirement for Federal agencies to "request of the Secretary of the Interior information whether any species which is listed or proposed to be listed may be present in the area of a proposed action". Please use this list to determine whether your project requires consultation and to make your effects determination. For more guidance, use the Guideline for Consultation under Section 7 of the Endangered Species Act with the Caribbean Ecological Services Field Office by clicking [here](#).

This species list is provided by:

Caribbean Ecological Services Field Office

caribbean_es@fws.gov

Post Office Box 491

Boqueron, PR 00622-0491

(786) 244-0081

Attachment(s):

- Official Species List
- USFWS National Wildlife Refuges and Fish Hatcheries
- Bald & Golden Eagles
- Migratory Birds
- Wetlands

OFFICIAL SPECIES LIST

This list is provided pursuant to Section 7 of the Endangered Species Act, and fulfills the requirement for Federal agencies to "request of the Secretary of the Interior information whether any species which is listed or proposed to be listed may be present in the area of a proposed action".

This species list is provided by:

Caribbean Ecological Services Field Office

Post Office Box 491

Boqueron, PR 00622-0491

(939) 320-3135

PROJECT SUMMARY

Project Code: 2024-0098241

Project Name: IPGM-00375

Project Type: Commercial Development

Project Description: The project consists of the construction of a Hybrid Power Plant for the Econo supermarket chain's distribution center in Canóvanas, Puerto Rico.

Project Location:

The approximate location of the project can be viewed in Google Maps: <https://www.google.com/maps/@18.3727594,-65.9063982006751,14z>

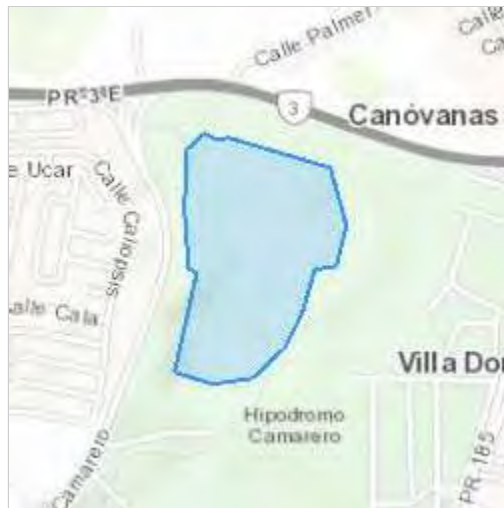

Counties: Canóvanas County, Puerto Rico

ENDANGERED SPECIES ACT SPECIES

There is a total of 1 threatened, endangered, or candidate species on this species list.

Species on this list should be considered in an effects analysis for your project and could include species that exist in another geographic area. For example, certain fish may appear on the species list because a project could affect downstream species.

IPaC does not display listed species or critical habitats under the sole jurisdiction of NOAA Fisheries¹, as USFWS does not have the authority to speak on behalf of NOAA and the Department of Commerce.

See the "Critical habitats" section below for those critical habitats that lie wholly or partially within your project area under this office's jurisdiction. Please contact the designated FWS office if you have questions.

-
1. [NOAA Fisheries](#), also known as the National Marine Fisheries Service (NMFS), is an office of the National Oceanic and Atmospheric Administration within the Department of Commerce.

REPTILES

NAME	STATUS
Puerto Rican Boa <i>Chilabothrus inornatus</i> No critical habitat has been designated for this species. Species profile: https://ecos.fws.gov/ecp/species/6628 General project design guidelines: https://ipac.ecosphere.fws.gov/project/QSWWSQUUPTFDV7KPAWBHT6DCIPQ/documents/generated/7159.pdf	Endangered

CRITICAL HABITATS

THERE ARE NO CRITICAL HABITATS WITHIN YOUR PROJECT AREA UNDER THIS OFFICE'S JURISDICTION.

YOU ARE STILL REQUIRED TO DETERMINE IF YOUR PROJECT(S) MAY HAVE EFFECTS ON ALL ABOVE LISTED SPECIES.

USFWS NATIONAL WILDLIFE REFUGE LANDS AND FISH HATCHERIES

Any activity proposed on lands managed by the [National Wildlife Refuge](#) system must undergo a 'Compatibility Determination' conducted by the Refuge. Please contact the individual Refuges to discuss any questions or concerns.

THERE ARE NO REFUGE LANDS OR FISH HATCHERIES WITHIN YOUR PROJECT AREA.

BALD & GOLDEN EAGLES

Bald and golden eagles are protected under the Bald and Golden Eagle Protection Act¹ and the Migratory Bird Treaty Act².

Any person or organization who plans or conducts activities that may result in impacts to bald or golden eagles, or their habitats³, should follow appropriate regulations and consider implementing appropriate conservation measures, as described in the links below. Specifically, please review the "[Supplemental Information on Migratory Birds and Eagles](#)".

-
1. The [Bald and Golden Eagle Protection Act](#) of 1940.
 2. The [Migratory Birds Treaty Act](#) of 1918.
 3. 50 C.F.R. Sec. 10.12 and 16 U.S.C. Sec. 668(a)

THERE ARE NO BALD AND GOLDEN EAGLES WITHIN THE VICINITY OF YOUR PROJECT AREA.

MIGRATORY BIRDS

Certain birds are protected under the Migratory Bird Treaty Act¹ and the Bald and Golden Eagle Protection Act².

Any person or organization who plans or conducts activities that may result in impacts to migratory birds, eagles, and their habitats³ should follow appropriate regulations and consider implementing appropriate conservation measures, as described in the links below. Specifically, please review the "[Supplemental Information on Migratory Birds and Eagles](#)".

1. The [Migratory Birds Treaty Act](#) of 1918.
2. The [Bald and Golden Eagle Protection Act](#) of 1940.
3. 50 C.F.R. Sec. 10.12 and 16 U.S.C. Sec. 668(a)

THERE ARE NO FWS MIGRATORY BIRDS OF CONCERN WITHIN THE VICINITY OF YOUR PROJECT AREA.

WETLANDS

Impacts to [NWI wetlands](#) and other aquatic habitats may be subject to regulation under Section 404 of the Clean Water Act, or other State/Federal statutes.

For more information please contact the Regulatory Program of the local [U.S. Army Corps of Engineers District](#).

Please note that the NWI data being shown may be out of date. We are currently working to update our NWI data set. We recommend you verify these results with a site visit to determine the actual extent of wetlands on site.

WETLAND INFORMATION WAS NOT AVAILABLE WHEN THIS SPECIES LIST WAS GENERATED. PLEASE VISIT [HTTPS://WWW.FWS.GOV/WETLANDS/DATA/MAPPER.HTML](https://www.fws.gov/wetlands/data/mapper.html) OR CONTACT THE FIELD OFFICE FOR FURTHER INFORMATION.

IPAC USER CONTACT INFORMATION

Agency: SCA Consulting Engr
Name: Hector Sanchez
Address: PO Box 2485
City: Guaynabo
State: PR
Zip: 00970
Email: hsanchez@scaeng.com
Phone: 7875020001

Appendix 10:
Critical Habitat Map

Appendix 10: Critical Habitat Map

Econo Energy Project

Project ID: IPGM-00375

Address: State Road PR-3, Int. PR 9959, Km. 15.21 Bo. Canovanillas, Canóvanas, PR. 00729

Coordinates: 18.373613° -65.906549°

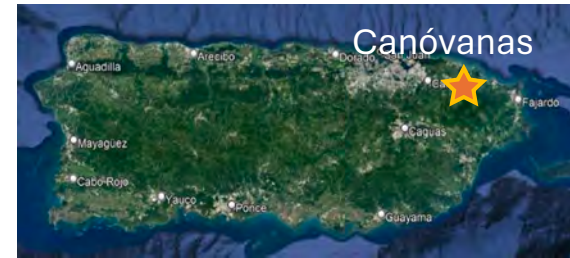

Home ▾ Critical Habitat for Threatened & Endangered Species [USFWS] Open in Map Viewer Modify Map Sign In

Details Basemap Share Print Measure Bookmarks Find address or place

About Content Legend

Legend

- Final Polygon Features
- Final Linear Features
- Proposed Polygon Features
- Proposed Linear Features

6.63 Miles

Site

Help Trust Center Legal Contact Esri Report Abuse Contact Us POWERED BY Earthstar Geographics esri

Source: <https://ecos.fws.gov/ecp/report/critical-habitat>, accessed 6/1/2024

Appendix 11:

Conservation Measures for the Puerto Rican Boa 2024



U.S. FISH AND WILDLIFE SERVICE CARIBBEAN ECOLOGICAL SERVICES FIELD OFFICE

Conservation Measures for the Puerto Rican boa (*Chilabothrus inornatus*)

Section 7 (a)(1) of the Endangered Species Act (ESA) charges Federal agencies to aid in the conservation of listed species, and section 7 (a)(2) requires the agencies, through consultation with the U.S. Fish and Wildlife Service (Service), to ensure their activities are not likely to jeopardize the continued existence of listed species or adversely modify designated critical habitats. Section 7 applies to the management of Federal lands as well as Federal actions that may affect federally listed species, such as Federal approval of private activities through the issuance of Federal funding, permits, licenses, or other actions. Any person that injures, captures, or kills a Puerto Rico boa is subject to penalties under the ESA. If Federal funds or permits are needed, the funding or permitting agency should initiate Section 7 consultation with the Service. To initiate a consultation under the Section 7 of the ESA, you must submit a project package with the established minimum requirements. These conservation measures should be incorporated into the project plans to minimize possible impacts to the species.

The endangered Puerto Rican (PR) boa (*Chilabothrus inornatus*, formerly *Epicrates inornatus*) is the largest endemic snake species that inhabits Puerto Rico. The PR boa is non-venomous and does not pose any life threatening danger to humans, but some individuals may try to bite if disturbed or during capture or handling. Its body color ranges from tan to dark brown with irregular diffuse marking on the dorsum, but some individuals lack marking and are uniformly dark. Juveniles may have a reddish color with more pronounced markings. In general, as they mature, their body color tends to darken.



The PR boa was federally listed in 1970. Currently, the species has an island-wide distribution and occurs in a wide variety of habitat types, ranging from wet montane to subtropical dry forest and can be found from mature forest to areas with different degrees of human disturbance such as roadsides or houses, especially if near their habitat in rural areas. The PR boa is considered mostly nocturnal, remaining less active, concealed or basking under the sun during the day.

The Service has developed the following conservation measures with the purpose of assisting others to avoid or minimize adverse effects to the PR boa and its habitat. These recommendations may be incorporated into new project plans and under certain circumstances into existing projects. Depending on the project, additional conservation measures can be implemented besides the ones presented in this document.

Conservation Measures:

1. Inform all project personnel about the potential presence of the PR boa in areas where the proposed work will be conducted. A pre-construction meeting should be conducted to inform all project personnel about the need to avoid harming the species as well as penalties for harassing or harming PR boas. An educational poster or sign with photo or illustration of the species should be displayed at the project site.
2. Prior to any construction activity, including removal of vegetation and earth movements, the boundaries of the project and areas to be excluded and protected should be clearly marked in the project plan and in the field in order to avoid further habitat degradation into forested and conservation areas.
3. Once areas are clearly marked, and prior to the use of heavy machinery and any construction activity (including removal of vegetation and earth movement), a biologist or project personnel with experience on this species should survey the areas to be cleared to verify the presence of any PR boa within the work area.
4. If a PR boa is found within any of the working or construction areas, activities should stop at that area and information recorded (see #5). **Do not capture the boa.** If boas need to be moved out of harm's way, designated personnel shall immediately contact the Puerto Rico Department of Natural and Environmental Resources (PRDNER) Rangers for safe capture and relocation of the animal (PRDNER phone #: (787) 724-5700, (787) 230-5550, (787) 771-1124). **If immediate relocation is not an option, project-related activities at that area must stop until the boa moves out of harm's way on its own.** Activities at other work sites, where no boas have been found after surveying the area, may continue.
5. For all boa sightings (dead or alive), record the time and date of the sighting and the specific location where it was found. PR boa data should also include a photo of the animal (dead or alive), site GPS coordinates, the time and date, and comments on how the animal was detected and its behavior.

6. If a PR boa is captured by PRDNER personnel, record the name of that person and information on where the PR boa will be taken. This information should be reported to the Service.
7. Measures should be taken to avoid and minimize PR boa casualties by heavy machinery or motor vehicles being used on site. Any heavy machinery left on site (staging) or near potential PR boa habitat (within 50 meters of potential boa habitat), needs to be thoroughly inspected each morning before work starts to ensure that no boas have sheltered within engine compartments or other areas of the equipment. If PR boas are found within vehicles or equipment, do not capture the animal, and let it move on its own or call PRDNER Rangers for safe capture and relocation of the animal (see #4). If not possible, the animal should be left alone until it leaves the vehicle on its own.
8. PR boas may seek shelter in debris piles. Measures should be taken to avoid and minimize boa casualties associated with sheltering in debris piles as a result of project activities. Debris piles should be placed far away from forested areas. Prior to moving, disposing or shredding, debris piles should be carefully inspected for the presence of boas. If debris piles will be left on site, we recommend they be placed in areas that will not be disturbed in the future.
9. If a dead PR boa is found, immediately cease all work in that area and record the information accordingly (see #5). If the PR boa was accidentally killed as part of the project actions, please include information on what conservation measures had been implemented and what actions will be taken to avoid further killings. A dead boa report should be sent by email (see contacts below) to the Service within 48 hours of the event.
10. Projects must comply with all state laws and regulations. Please contact the PRDNER for further guidance.

If you have any questions regarding the above conservation measures, please contact the Service:

- José Cruz-Burgos, Endangered Species Program Coordinator
 - Email: jose_cruz-burgos@fws.gov
 - Office phone (305) 304-1386
- Jan Zegarra, Fish and Wildlife Biologist
 - Email: jan_zegarra@fws.gov
 - Office phone (786) 933-1451

Appendix 10

Explosive and Flammable Hazards

Appendix 10

Distance to where people gather

Econo Energy Project

Project ID: IPGM-00375

Address: State Road PR-3, Int. PR 9959, Km. 15.21 Bo. Canovanillas, Canóvanas, PR. 00729

Coordinates: 18.373613° -65.906549°

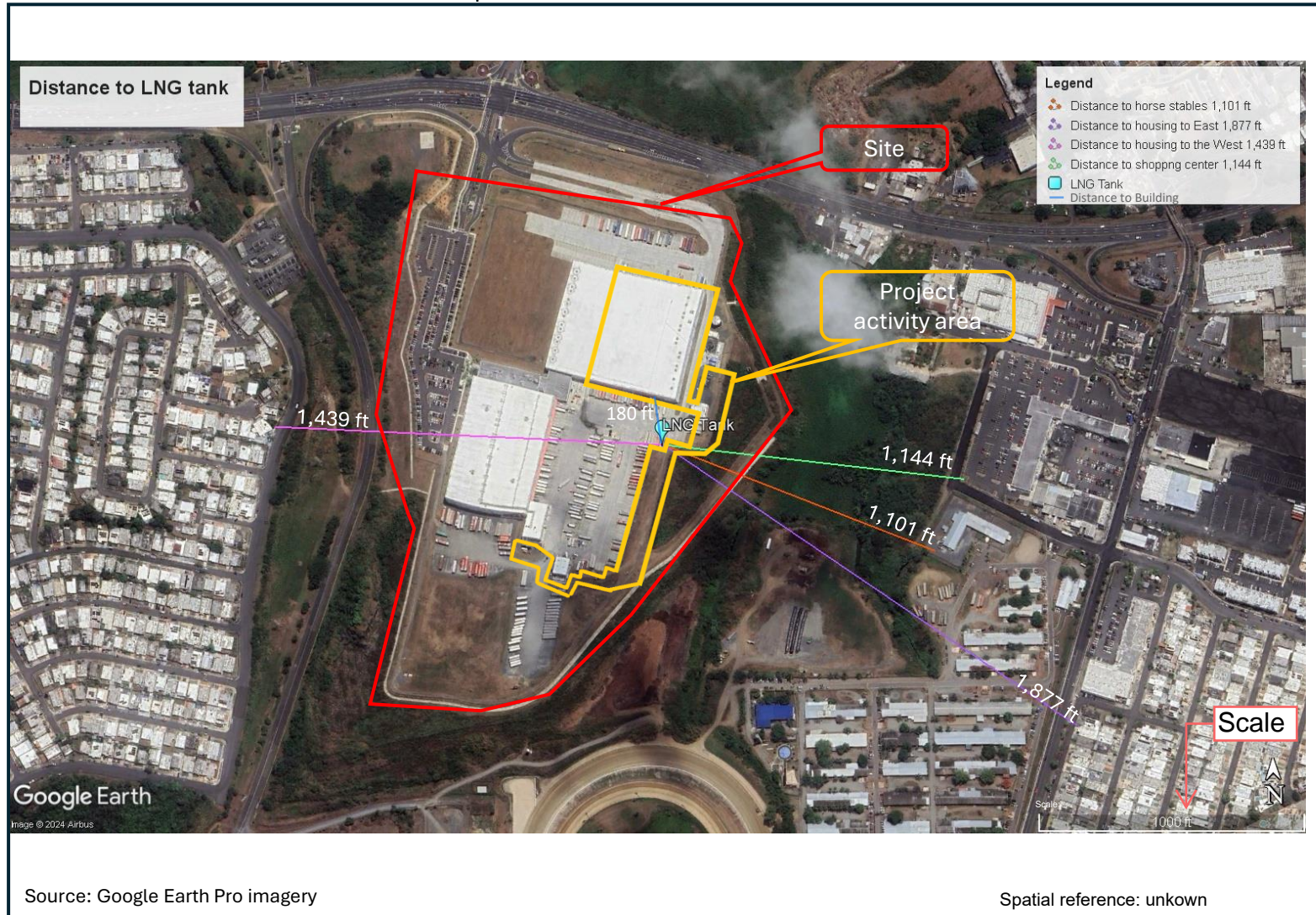

[Home \(/\)](#) > [Programs \(/programs/\)](#) > [Environmental Review \(/programs/environmental-review/\)](#) > ASD Calculator

Acceptable Separation Distance (ASD) Electronic Assessment Tool

The Environmental Planning Division (EPD) has developed an electronic-based assessment tool that calculates the Acceptable Separation Distance (ASD) from stationary hazards. The ASD is the distance from above ground stationary containerized hazards of an explosive or fire prone nature, to where a HUD assisted project can be located. The ASD is consistent with the Department's standards of blast overpressure (0.5 psi-buildings) and thermal radiation (450 BTU/ft² - hr - people and 10,000 BTU/ft² - hr - buildings). Calculation of the ASD is the first step to assess site suitability for proposed HUD-assisted projects near stationary hazards. Additional guidance on ASDs is available in the Department's guidebook "Siting of HUD- Assisted Projects Near Hazardous Facilities" and the regulation 24 CFR Part 51, Subpart C, Sitting of HUD-Assisted Projects Near Hazardous Operations Handling Conventional Fuels or Chemicals of an Explosive or Flammable Nature.

Note: Tool tips, containing field specific information, have been added in this tool and may be accessed by hovering over the ASD result fields with the mouse.

Acceptable Separation Distance Assessment Tool

Is the container above ground?	Yes: <input checked="" type="checkbox"/> No: <input type="checkbox"/>
Is the container under pressure?	Yes: <input checked="" type="checkbox"/> No: <input type="checkbox"/>
Does the container hold a cryogenic liquified gas?	Yes: <input checked="" type="checkbox"/> No: <input type="checkbox"/>
Is the container diked?	Yes: <input checked="" type="checkbox"/> No: <input type="checkbox"/>
What is the volume (gal) of the container?	<input type="text"/>
What is the Diked Area Length (ft)?	<input type="text" value="46"/>
What is the Diked Area Width (ft)?	<input type="text" value="32"/>
<input type="button" value="Calculate Acceptable Separation Distance"/>	
Diked Area (sqft)	<input type="text" value="1472"/>
ASD for Blast Over Pressure (ASDBOP)	<input type="text"/>
ASD for Thermal Radiation for People (ASDPPU)	<input type="text"/>
ASD for Thermal Radiation for Buildings (ASDBPU)	<input type="text"/>
ASD for Thermal Radiation for People (ASDPNPD)	<input type="text" value="181.84"/>
ASD for Thermal Radiation for Buildings (ASDBNPD)	<input type="text" value="31.75"/>

For mitigation options, please click on the following link: [Mitigation Options \(/resource/3846/acceptable-separation-distance-asd-hazard-mitigation-options/\)](#)

Providing Feedback & Corrections

After using the ASD Assessment Tool following the directions in this User Guide, users are encouraged to provide feedback on how the ASD Assessment Tool may be improved. Users are also encouraged to send comments or corrections for the improvement of the tool.

Please send comments or other input using the **Contact Us** (<https://www.hudexchange.info/contact-us/>) form.

Related Information

- [ASD User Guide \(/resource/3839/acceptable-separation-distance-asd-assessment-tool-user-guide/\)](/resource/3839/acceptable-separation-distance-asd-assessment-tool-user-guide/)
- [ASD Flow Chart \(/resource/3840/acceptable-separation-distance-asd-flowchart/\)](/resource/3840/acceptable-separation-distance-asd-flowchart/)

Appendix 11

Farmland Protection Act

Farmland Classification—Humacao Area, Puerto Rico Eastern Part
(Econo Energy Project / IPGM-00375)

65° 55' 26" W

65° 53' 20" W

18° 23' 2" N

18° 23' 2" N

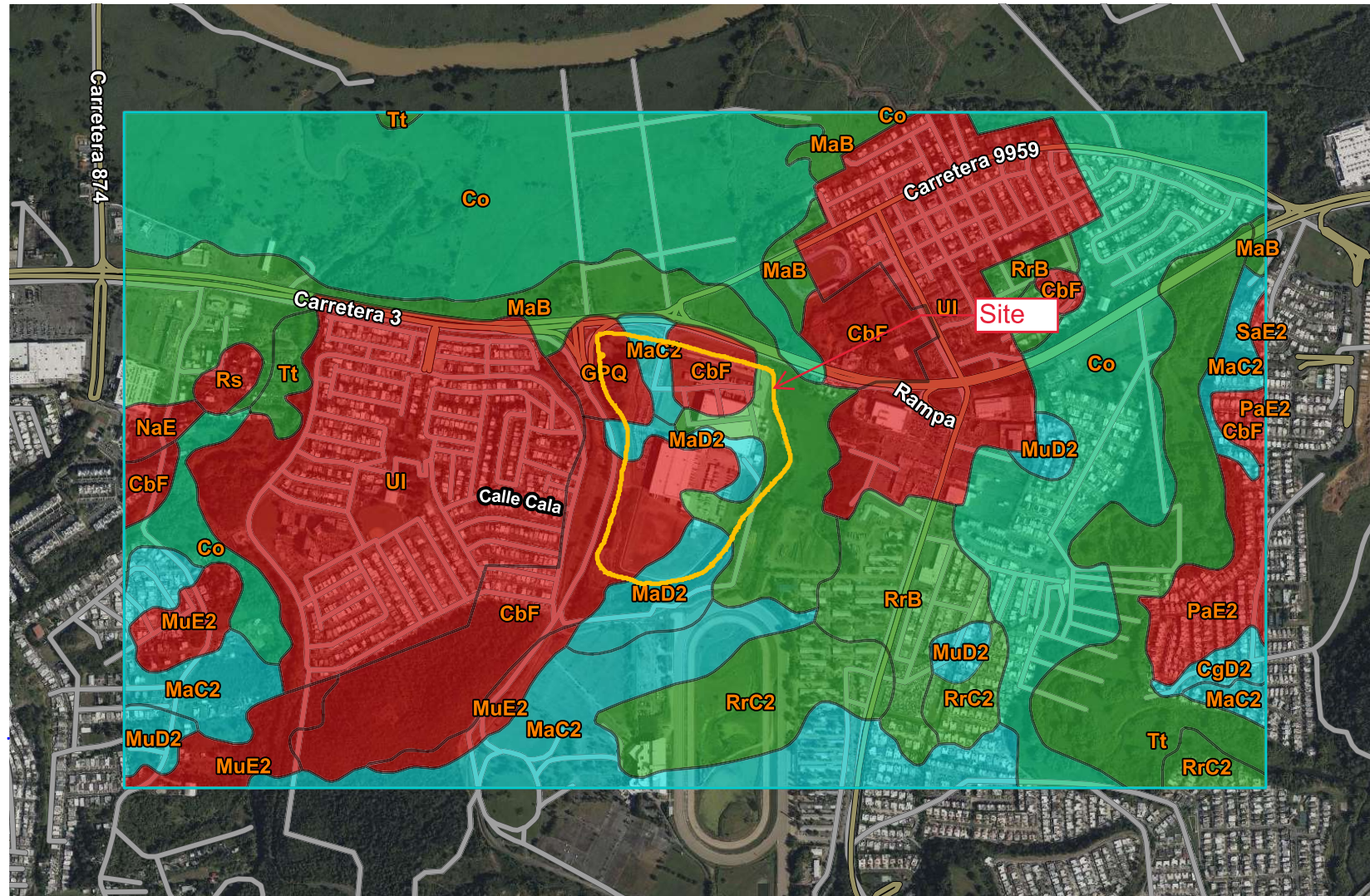

18° 21' 44" N

18° 21' 44" N

65° 55' 26" W

65° 53' 20" W

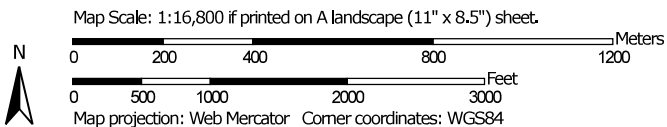

Econo Energy Project
 Project ID: IPGM-00375
 Address: State Road PR-3, Int. PR 9959, Km. 15.21 Bo. Canovanillas, Canóvanas, PR. 00729
 Coordinates: 18.373613° -65.906549°

Farmland Classification—Humacao Area, Puerto Rico Eastern Part
(Econo Energy Project / IPGM-00375)









MAP LEGEND







Area of Interest (AOI)





 Area of Interest (AOI)







Soils



Soil Rating Polygons

-  Not prime farmland
-  All areas are prime farmland
-  Prime farmland if drained
-  Prime farmland if protected from flooding or not frequently flooded during the growing season
-  Prime farmland if irrigated
-  Prime farmland if drained and either protected from flooding or not frequently flooded during the growing season
-  Prime farmland if irrigated and drained
-  Prime farmland if irrigated and either protected from flooding or not frequently flooded during the growing season







-  Prime farmland if subsoiled, completely removing the root inhibiting soil layer
-  Prime farmland if irrigated and the product of I (soil erodibility) x C (climate factor) does not exceed 60
-  Prime farmland if irrigated and reclaimed of excess salts and sodium
-  Farmland of statewide importance
-  Farmland of statewide importance, if drained
-  Farmland of statewide importance, if protected from flooding or not frequently flooded during the growing season
-  Farmland of statewide importance, if irrigated

-  Farmland of statewide importance, if drained and either protected from flooding or not frequently flooded during the growing season
-  Farmland of statewide importance, if irrigated and drained
-  Farmland of statewide importance, if irrigated and either protected from flooding or not frequently flooded during the growing season
-  Farmland of statewide importance, if subsoiled, completely removing the root inhibiting soil layer
-  Farmland of statewide importance, if irrigated and the product of I (soil erodibility) x C (climate factor) does not exceed 60

























-  Farmland of statewide importance, if irrigated and reclaimed of excess salts and sodium
-  Farmland of statewide importance, if drained or either protected from flooding or not frequently flooded during the growing season
-  Farmland of statewide importance, if warm enough, and either drained or either protected from flooding or not frequently flooded during the growing season
-  Farmland of statewide importance, if warm enough
-  Farmland of statewide importance, if thawed
-  Farmland of local importance
-  Farmland of local importance, if irrigated

-  Farmland of unique importance
-  Not rated or not available



Soil Rating Lines

-  Not prime farmland
-  All areas are prime farmland
-  Prime farmland if drained
-  Prime farmland if protected from flooding or not frequently flooded during the growing season
-  Prime farmland if irrigated
-  Prime farmland if drained and either protected from flooding or not frequently flooded during the growing season
-  Prime farmland if irrigated and drained
-  Prime farmland if irrigated and either protected from flooding or not frequently flooded during the growing season

Farmland Classification—Humacao Area, Puerto Rico Eastern Part
(Econo Energy Project / IPGM-00375)

	Prime farmland if subsoiled, completely removing the root inhibiting soil layer		Farmland of statewide importance, if drained and either protected from flooding or not frequently flooded during the growing season		Farmland of statewide importance, if irrigated and reclaimed of excess salts and sodium		Farmland of unique importance		Prime farmland if subsoiled, completely removing the root inhibiting soil layer
	Prime farmland if irrigated and the product of I (soil erodibility) x C (climate factor) does not exceed 60		Farmland of statewide importance, if irrigated and drained		Farmland of statewide importance, if drained or either protected from flooding or not frequently flooded during the growing season	Soil Rating Points			Prime farmland if irrigated and the product of I (soil erodibility) x C (climate factor) does not exceed 60
	Prime farmland if irrigated and reclaimed of excess salts and sodium		Farmland of statewide importance, if irrigated and either protected from flooding or not frequently flooded during the growing season		Farmland of statewide importance, if warm enough, and either drained or either protected from flooding or not frequently flooded during the growing season		Not prime farmland		Prime farmland if irrigated and reclaimed of excess salts and sodium
	Farmland of statewide importance		Farmland of statewide importance, if subsoiled, completely removing the root inhibiting soil layer		Farmland of statewide importance, if warm enough		Prime farmland if drained		Farmland of statewide importance
	Farmland of statewide importance, if protected from flooding or not frequently flooded during the growing season		Farmland of statewide importance, if irrigated and the product of I (soil erodibility) x C (climate factor) does not exceed 60		Farmland of statewide importance, if thawed		Prime farmland if irrigated		Farmland of statewide importance, if drained
	Farmland of statewide importance, if irrigated				Farmland of local importance		Prime farmland if drained and either protected from flooding or not frequently flooded during the growing season		Farmland of statewide importance, if protected from flooding or not frequently flooded during the growing season
					Farmland of local importance, if irrigated		Prime farmland if irrigated and drained		Farmland of statewide importance, if irrigated
							Prime farmland if irrigated and either protected from flooding or not frequently flooded during the growing season		

**Farmland Classification—Humacao Area, Puerto Rico Eastern Part
(Econo Energy Project / IPGM-00375)**

 Farmland of statewide importance, if drained and either protected from flooding or not frequently flooded during the growing season	 Farmland of statewide importance, if irrigated and reclaimed of excess salts and sodium	 Farmland of unique importance  Not rated or not available	<p>The soil surveys that comprise your AOI were mapped at 1:20,000.</p>
 Farmland of statewide importance, if irrigated and drained	 Farmland of statewide importance, if drained or either protected from flooding or not frequently flooded during the growing season	<p>Water Features</p>  Streams and Canals	<p>Please rely on the bar scale on each map sheet for map measurements.</p>
 Farmland of statewide importance, if irrigated and either protected from flooding or not frequently flooded during the growing season	 Farmland of statewide importance, if warm enough, and either drained or either protected from flooding or not frequently flooded during the growing season	<p>Transportation</p>  Rails	<p>Source of Map: Natural Resources Conservation Service Web Soil Survey URL: Coordinate System: Web Mercator (EPSG:3857)</p>
 Farmland of statewide importance, if subsoiled, completely removing the root inhibiting soil layer	 Farmland of statewide importance, if warm enough	 Interstate Highways	<p>Maps from the Web Soil Survey are based on the Web Mercator projection, which preserves direction and shape but distorts distance and area. A projection that preserves area, such as the Albers equal-area conic projection, should be used if more accurate calculations of distance or area are required.</p>
 Farmland of statewide importance, if irrigated and the product of I (soil erodibility) x C (climate factor) does not exceed 60	 Farmland of statewide importance, if thawed	 US Routes	<p>This product is generated from the USDA-NRCS certified data as of the version date(s) listed below.</p>
	 Farmland of local importance	 Major Roads	<p>Soil Survey Area: Humacao Area, Puerto Rico Eastern Part Survey Area Data: Version 15, Sep 13, 2023</p>
	 Farmland of local importance, if irrigated	 Local Roads	<p>Soil map units are labeled (as space allows) for map scales 1:50,000 or larger.</p>
		<p>Background</p>  Aerial Photography	<p>Date(s) aerial images were photographed: Jan 23, 2022—Mar 1, 2022</p>
			<p>The orthophoto or other base map on which the soil lines were compiled and digitized probably differs from the background imagery displayed on these maps. As a result, some minor shifting of map unit boundaries may be evident.</p>

Farmland Classification

Map unit symbol	Map unit name	Rating	Acres in AOI	Percent of AOI
CbF	Caguabo clay loam, 20 to 60 percent slopes	Not prime farmland	123.2	9.0%
CgD2	Cayagua sandy loam, 12 to 20 percent slopes, eroded	Farmland of statewide importance	6.1	0.4%
Co	Coloso silty clay loam, 0 to 2 percent slopes, occasionally flooded	Prime farmland if drained	361.7	26.5%
GPQ	Gravel, Pits, Quarries	Not prime farmland	13.1	1.0%
MaB	Mabi clay, 0 to 5 percent slopes	All areas are prime farmland	130.8	9.6%
MaC2	Mabi clay, 5 to 12 percent slopes, eroded	Farmland of statewide importance	124.5	9.1%
MaD2	Mabi clay, 12 to 20 percent slopes, eroded	Farmland of statewide importance	26.4	1.9%
MuD2	Mucara silty clay loam, 12 to 20 percent slopes, eroded	Farmland of statewide importance	16.2	1.2%
MuE2	Mucara silty clay loam, 20 to 40 percent slopes, eroded	Not prime farmland	38.5	2.8%
NaE	Naranjito silty clay loam, 20 to 40 percent slopes	Not prime farmland	5.7	0.4%
PaE2	Pandura loam, 12 to 40 percent slopes, eroded	Not prime farmland	24.6	1.8%
RrB	Rio Arriba clay, 2 to 5 percent slopes	All areas are prime farmland	48.4	3.5%
RrC2	Rio Arriba clay, 5 to 12 percent slopes, eroded	All areas are prime farmland	60.8	4.4%
Rs	Rock land	Not prime farmland	5.5	0.4%
SaE2	Sabana silty clay loam, 20 to 40 percent slopes, eroded	Not prime farmland	1.6	0.1%
Tt	Toa silty clay loam, 0 to 2 percent slopes, occasionally flooded	All areas are prime farmland	88.0	6.4%
UI	Urban land	Not prime farmland	291.6	21.3%
Totals for Area of Interest			1,366.7	100.0%

Description

Farmland classification identifies map units as prime farmland, farmland of statewide importance, farmland of local importance, or unique farmland. It identifies the location and extent of the soils that are best suited to food, feed, fiber, forage, and oilseed crops. NRCS policy and procedures on prime and unique farmlands are published in the "Federal Register," Vol. 43, No. 21, January 31, 1978.

Rating Options

Aggregation Method: No Aggregation Necessary

Aggregation is the process by which a set of component attribute values is reduced to a single value that represents the map unit as a whole.

A map unit is typically composed of one or more "components". A component is either some type of soil or some nonsoil entity, e.g., rock outcrop. For the attribute being aggregated, the first step of the aggregation process is to derive one attribute value for each of a map unit's components. From this set of component attributes, the next step of the aggregation process derives a single value that represents the map unit as a whole. Once a single value for each map unit is derived, a thematic map for soil map units can be rendered. Aggregation must be done because, on any soil map, map units are delineated but components are not.

For each of a map unit's components, a corresponding percent composition is recorded. A percent composition of 60 indicates that the corresponding component typically makes up approximately 60% of the map unit. Percent composition is a critical factor in some, but not all, aggregation methods.

The majority of soil attributes are associated with a component of a map unit, and such an attribute has to be aggregated to the map unit level before a thematic map can be rendered. Map units, however, also have their own attributes. An attribute of a map unit does not have to be aggregated in order to render a corresponding thematic map. Therefore, the "aggregation method" for any attribute of a map unit is referred to as "No Aggregation Necessary".

Tie-break Rule: Lower

The tie-break rule indicates which value should be selected from a set of multiple candidate values, or which value should be selected in the event of a percent composition tie.

Appendix 11b Census TIGER Map

Econo Energy Project

Project ID: IPGM-00375

Address: State Road PR-3, Int. PR 9959, Km. 15.21 Bo.
Canovanillas, Canóvanas, PR. 00729

Coordinates: 18.373613° -65.906549°



TIGERweb



December 11, 2024

Counties 2020 Urban Areas Counties
States 2020 Urban Areas States

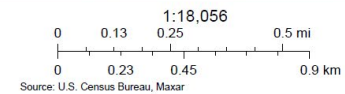

Source: United States Census, <https://tigerweb.geo.census.gov/tigerweb/>, Dec 11, 2024

Created with: TIGERweb
(c)Copyright 2024 - US Census Bureau

Appendix 12

Floodplain Management

Econo Energy Project

Project ID: IPGM-00375

Address: State Road PR-3, Int. PR 9959, Km. 15.21 Bo. Canovanillas, Canóvanas, PR. 00729

Coordinates: 18.373613° -65.906549°

Floodplain management evaluation

The conditions for the decision-making process have been updated by HUD under a revised rule 24 CFR Part 55 which became effective on May 23, 2023. There are certain clauses under this new rule that apply to this project and are presented here for documentation with the Environmental Review process. The intention of this evaluation is to streamline the floodplain management process, ensure adequate use of public funds, while transitioning to new regulations.

According to the updated 24 CFR Part 55, certain activities under **§55.13, *Inapplicability of 8-step decision making process to certain categories of proposed actions***, do not require the 8-step process, despite them being in floodplain.

For other activities, the federal agency has determined that a 5-step process is the appropriate approach for evaluation under Part 55. These are described under **§55.14, *Modified 5-step decision-making process for certain categories of proposed actions***. However, there are no categories in this section that seem appropriate for this project type.

§ 55.13 Inapplicability of 8-step decision making process to certain categories of proposed actions.

Under this section of the revised regulation, **§55.13 (f)** is a new exception to the 8-step process. It reads:

The decision-making process in § 55.20 shall not apply to the following categories of proposed actions:

....

(f) Special projects for the purpose of improving the energy or water efficiency of utilities or installing renewable energy that involve the repair, rehabilitation, modernization, weatherization, or improvement of existing structures or infrastructure, do not meet the thresholds for “substantial improvement” under §55.2(b)(12), and do not include the installation of equipment below the FFRMS floodplain elevation; and

The Federal Register (FR) indicates that this new exception intends to “limit procedural hurdles to energy or water efficiency retrofit projects, which have limited potential to adversely affect floodplains or wetlands” (Federal Register, Vol 89, No. 79, April 23, 2024, p. 30857).

The FR goes on to clarify that this exemption is intended to “benefit any project that improves energy or water efficiency or installs renewable energy that does not meet the threshold for substantial improvement and does not wish to limit fossil fuel projects to only those where there is no electric alternative.” So the exception is not limited to projects for renewable energy, but also includes projects that use conventional fossil fuel alternatives. This supports the agency’s position on the need to advance all types of projects that improve energy or water efficiency as a priority, as the agency and it intend to process those in an expedited manner.

As stated in the regulations, to be able to apply exemption **§55.13 (f)**, the project must meet two criteria: 1) not exceed or meet the thresholds for “substantial improvement” and 2) equipment installation must be above FFRMS floodplain elevation. These criteria are analyzed below.

Substantial Improvement analysis

The activity must “not meet the thresholds for “substantial improvement” under §55.12(b)(12)”, which reads:

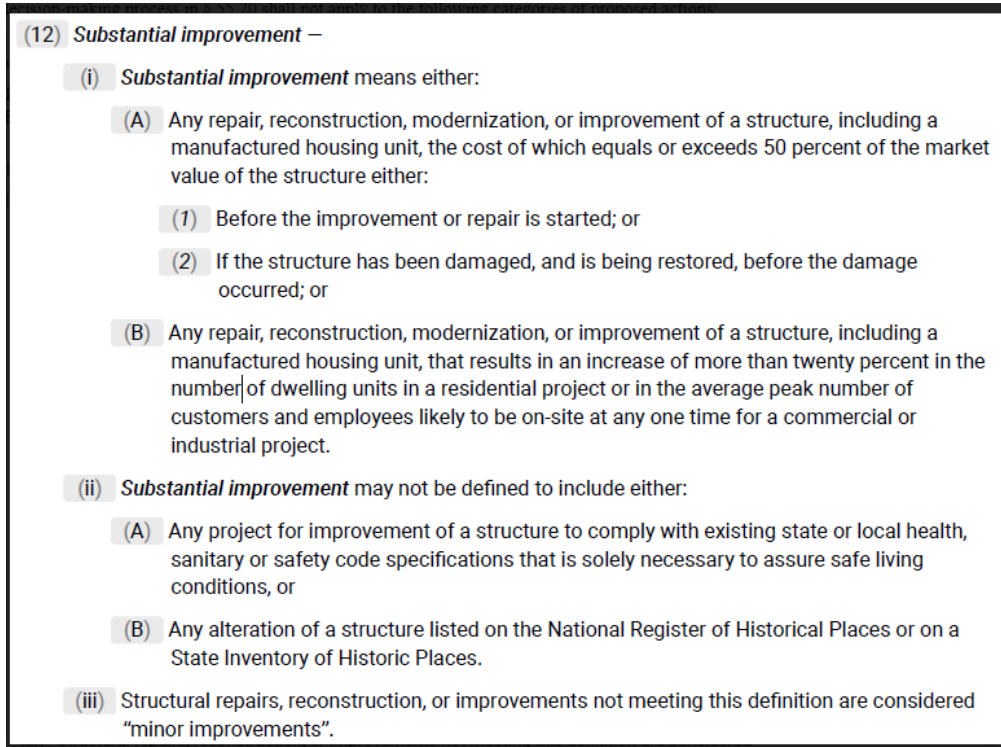

Figure 1 - Substantial improvement definition from 24 Part 55

Since the activity is not related to an improvement because of a damage, the section that needs to be evaluated is 12(i)(A)(1), which refers to the market value of a structure BEFORE the improvement or repair is started. Since this property was developed recently, it is new to the market. As a comparison we will use the property’s appraisal value (Appraisal Report June 1, 2021) and compare it with the proposed project cost, these are presented in Table 1 below. The substantial improvement cost does not exceed 50% of the market value.

Table 1- Substantial Improvement Calculation

A) Property Appraisal Value*	\$81,900,000
B) Estimated Project Cost	\$19,149,819
C) Substantial Improvement (B/A *100%)	23.38%

*Appraisal Report June 1, 2021

Econo Energy Project

Project ID: IPGM-00375

Floodplain management evaluation

The part of the definition of substantial improvement under part 12(i)(B) is met because the project will not result in an increase of more than 20% the employees that are available at the site. Mainly because the project does not affect the workflow or general operations at the site but ensures that the site can operate during massive power outages or voltage fluctuations. The activity will result in 3 to 5 additional employees for the operation of the hybrid plant once it is installed and active.

FFRMS floodplain elevation

The second condition for the exemption **§55.13 (f)** is that the equipment installation needs to be above the **FFRMS floodplain elevation**. As per the updated HUD regulation, there are 3 ways to obtain the FFRMS floodplain elevation: 1) Climate-Informed Science Approach (CISA), 2) 0.2 Percent-Annual-Chance Floodplain Approach (0.2PFA) and 3) Freeboard Value Approach.

HUD will implement a tool resource to define the floodplain using CISA, as of May 2024, Federal CISA resources have not been adopted by HUD, but, as indicated in HUDs May 30, 2024 presentation (included as an attachment), the Federal Flood Standard Support Tool (FFSST) can be used to document floodplain analysis. This is the Federal Flood Standard Support Tool Beta v1.1.5 which was accessed at <https://floodstandard.climate.gov/> to obtain the FFRMS data available. Since the tool is under development, the CISA map is not available yet for the location, and the FIRM map does not provide a 0.2 Percent-Annual-Chance Floodplain value. However, the tool did provide a FVA report (included as an attachment) and obtained from the website. From this report, the FFRMS FVA flood elevation is **35.1 FT**, which converts to **10.7 meters**.

As an additional resource, the Advisory Base Flood Elevation maps for the site was consulted (<https://gis-r2-fema.hub.arcgis.com/pages/puertorico>), but the ABFE lacks specific base flood elevation at the project location or adjacent areas.

Verification of site elevation

To address if the project elevation is above this FFRMS elevation, the as-built site topography was verified to assess the elevation where the project components will be located. In general, the elevation in the area where the natural gas tank and its utilities will be installed ranges between 13.96 to 14.14 m. In the area where the new gas-powered generator will be installed, the elevation is between 14.0 to 14.25 m. The solar panels will be installed on the rooftop of the Dry Storage Building, which its floor elevation is 16.00 m.

The Figures below are images of these areas from the as-built topography maps. The complete maps will be available for review.

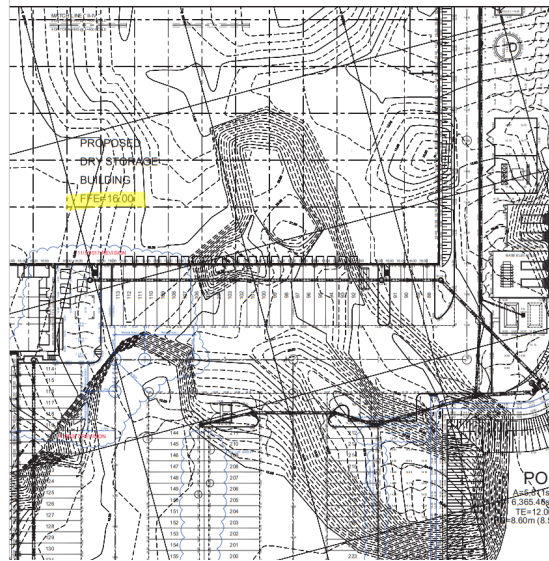

Figure 4 – as-built topography where the solar panels will be installed.

In order to verify the elevation with other sources, the USGS Elevation Point Query Service (<https://apps.nationalmap.gov/epqs/>) was utilized. Provided with latitude and longitude of a location, this site returns the elevation for the specific point. HUD, in its FFRMS presentation held on May 30, 2024, via HUD Exchange, has suggested that this site be used, along with other sources to verify or confirm the elevation at a particular point. Thus, this is a useful tool to aid in the floodplain management evaluation of a site. Using the project coordinates for the project, the elevation obtained is **15.66 m** (see screen image of the result below).

```
{  
  "location": {  
    "x": -65.906549,  
    "y": 18.373613,  
    "spatialReference": {  
      "wkid": 4326,  
      "latestWkid": 4326  
    }  
  },  
  "locationId": 0,  
  "value": "15.655456543",  
  "rasterId": 14637,  
  "resolution": 1  
}
```

Figure 5 - Image USGS Elevation Point Query Service

With these two sources of information, it can be confirmed that the site and project area is above 10.7 meters of the FVA elevation.

Wetlands

The proposed project will be developed within the confinement of an industrial/commercial facility. The project area does not have any wetlands on it, based on photos of the existing conditions of the project. This aligns with §55.9, Identifying wetlands, where it indicates that identification of wetlands be performed by a visual assessment.

Based on the National Wetlands Inventory map (see figure 6), the site is in proximity of offsite wetlands, which are identified to be located beyond the retention pond located directly to the East of the site.

The yellow area in figure 6 shows the project's impact zone, which does not intersect with any wetlands. The document also includes the Wetland Delineation Study prepared for the site in 2016.

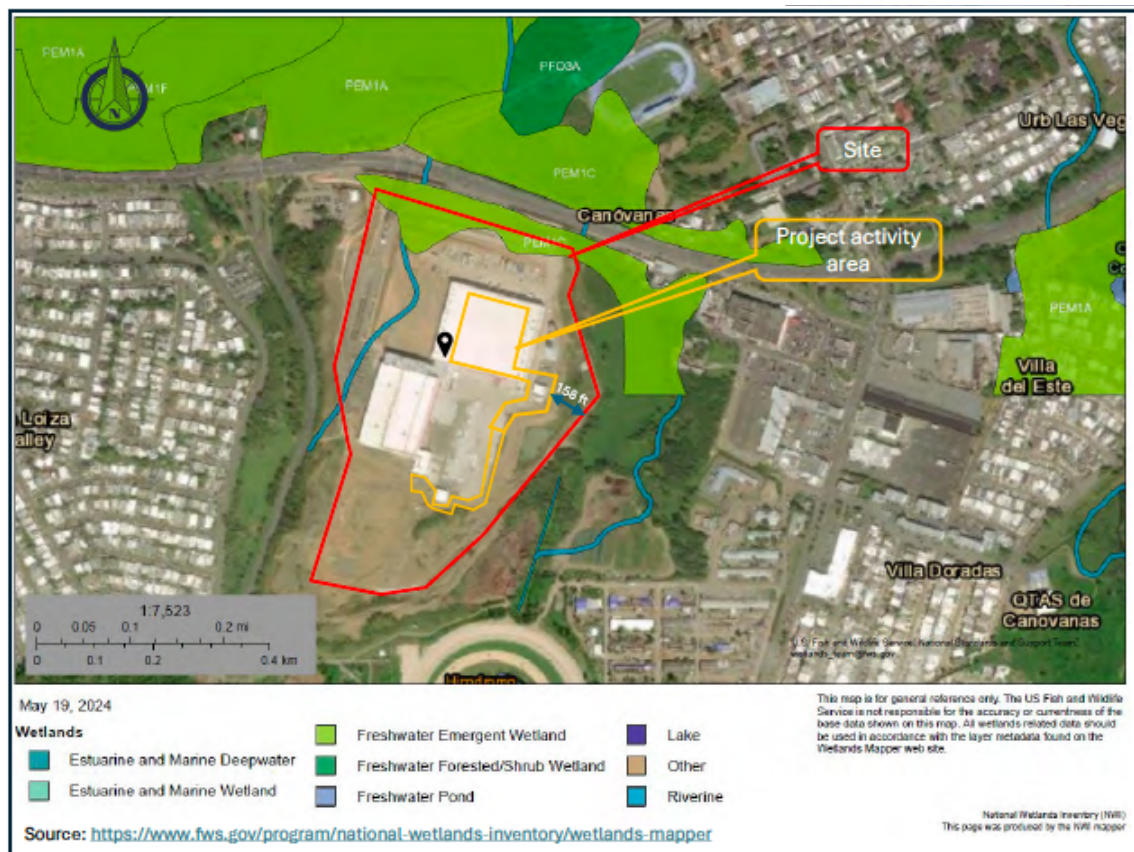

Figure 6 - Image USGS Elevation Point Query Service

§55.10 goes on to address the limitations of HUD assistance in wetlands. There are 3 limitations, as included below, in italics.

55.10 (a) When the proposed project includes new construction activities (including grading, clearing, draining, filling, diking, impounding, and related activities for any structure or facilities including the siting of new manufactured housing units) that will have a direct impact to onsite

Econo Energy Project

Project ID: IPGM-00375

Floodplain management evaluation

wetlands identified by the process described in § 55.9, compliance with this part requires the completion of the 8-step decision making process in § 55.20 to address wetland impacts.

As presented, the proposed project will NOT have a direct impact to onsite wetlands because the construction area does not have any wetlands. This is true even if, for the purpose of this evaluation, we consider that the retention pond as a wetland. As such, the pond may be “onsite wetlands”, however, no grading, clearing, draining, filling, diking, impounding, or related activity will take place there, thus no direct impact will occur to “onsite wetlands.” This clause does not trigger the 8-step process is not required.

55.10 (b) When the proposed project may indirectly affect wetlands by modifying the flow of stormwater, releasing pollutants, or otherwise changing conditions that contribute to wetlands viability, the significance of these impacts must be evaluated and the impacts minimized through best management practices. If the project site includes wetlands that will not be impacted by new construction, HUD strongly encourages measures to preserve such wetlands from future impacts, including by obtaining a restrictive covenant, conservation easement, or other mechanism.

The proposed project will not affect the flow of storm water, release pollutants, or otherwise change conditions that contribute to wetland viability. The activity will not affect the current patterns of storm water of the site, which will continue to discharge to the pond. The construction/installation of the proposed elements will not release pollutants to the environment which may alter the wetland composition. In any case, it can be argued that the ground disturbance at the site may impact the stormwater due to possibility of erosion or sedimentation movement during construction only. However, this impact will be minimized through best management practices. As described in this section, this is not a reason for having to perform the 8-step process. The characteristics of the project help to further minimize the impact to off-site wetlands, given that a retention pond acts as a buffer to reduce impact to offsite wetlands. Thus, there is an added protection to offsite wetlands from the pond itself and the impact to offsite wetlands is further minimized.

55.10 (c) When the proposed project may indirectly affect off-site wetlands, impacts should be minimized to the extent practicable. While this part does not require further decision making to address these effects under the authority of Executive Order 11990, measures to address offsite wetlands impacts may be necessary to comply with related laws and authorities including the Endangered Species Act or to address significant impacts under the National Environmental Policy Act.

On section (c), the regulation goes on to state that “when the proposed project may indirectly affect off-site wetlands, impacts should be minimized to the extent practicable.” There is no need to perform an 8-step or 5-step process for these instances.

Thus, for this project there will be no direct impact on onsite wetlands because there are none. Also, indirect impact to offsite wetland may be addressed with best management practices, as stated by the regulation. Therefore, with respect to impacts to wetlands, no decision-making process needs to be addressed.

Conclusion

As verified, the project estimates do not exceed the substantial improvement definition, using the appraisal value of the property and comparing with the estimated costs for the project, the project has a 21% substantial value cost. The elevation of the site and the location of the new components was verified using two sources, and it exceeds the FFRMS elevation obtained from the FVA data.

Econo Energy Project

Project ID: IPGM-00375

Floodplain management evaluation

Regarding wetland impact, there are no on-site wetlands that could be affected by the proposed action. Offsite wetlands are identified on NWI maps to be beyond the retention pond built for the facility. The implementation of best management practices, such as an erosion and sedimentation control plan, along with the buffer that the retention pond offers, is sufficient to minimize potential indirect impacts to wetlands. According to **§55.10 (b)**, a BMP approach does not trigger the 8-step process. Furthermore, **§55.10 (c)** supports that impact to off-site wetlands can be minimized, but this does not trigger a decision-making process.

Therefore, after evaluation HUD-provided guidance to navigate the stipulations of the updated 24 Part 55 regulations, it is concluded that the exemption **§55.13 (f)** and **§55.10 (b)** sections apply to project IPGM-00375 and the project does not require an 8-step process for compliance with the Floodplain Management and Protection of Wetlands regulation. This is consistent with the intent of the new exemption **§55.13 (f)**, as stated in the Federal Register, which is to limit “procedural hurdles to energy or water efficiency retrofit projects, which have limited potential to adversely affect floodplains or wetlands”

Performing the decision-making process, whether a 5-step or an 8-step process for this project is futile and contrary to the federal regulation. Given these new provisions, an 8-step process also seems appear to be a misuse of federal funds, time consuming processes, and disregarding new federal rules and mandates.

Appendix List

IPGM-00375

1	FFRMS Freeboard Value Approach Report
2	Photos of existing site conditions
3	Appraisal Report 2021
4	Wetland Map
5	Jurisdictional Wetland Determination Study 2016

Appendix 1:
FFRMS Freeboard Value Approach Report



Summary

Based on the user-defined location and **non-critical** designation, the proposed action **is in** the FFRMS floodplain. A **2 foot freeboard** is applicable per the Freeboard Value Approach. This corresponds to a FFRMS flood elevation of **35.1 FT NAVD88**.

The North American Vertical Datum of 1988 (NAVD88) is the datum used on FEMA Digital Flood Insurance Rate Maps (DFIRMs) for Base Flood Elevations (BFEs).

Projects located in the FFRMS floodplain should be designed consistent with the applicable policies and directives of the agency taking or approving the action.

Proposed Action Details

Location centroid (Latitude, Longitude): **18°22'26.04"N 65°54'20.16"W**

Service criticality: **Non-critical** Service Life: **Through 2050**

Consult with the applicable agency to identify any agency-specific policies, guidance, protocols, or direction on the critical action determination. The services of a professional engineer, architect, or other licensed design professional are recommended for designing critical actions or assets with long intended service life, and for other situations where risk tolerance is low because of unique characteristics of the action.

Considerations of Freeboard approach at this location

- **Water Surface Elevation Definition:** Water surface elevation (WSEL) means the height, in relation to the North American Vertical Datum of 1988 (NAVD 88) of floods of various magnitudes and frequencies in the floodplains of coastal or riverine areas. Potential area where the computed WSEL have discrepancies and may have impacted FFRMS floodplains.

Next Steps

This is the Step 1 of the 8-step decision-making process required in section 2(a) of Executive Order 11988, Floodplain Management (Determine if the proposed action within the FFRMS floodplain). Follow the remainder of the 8-step process outlined in the [Implementation Guidelines \(2015\)](#), page 4, including Step 5 which include minimizing harm and restoring and preserving natural and beneficial values. (Please refer to the Nature Based Solutions section). A licensed design professional should be contacted for the design or engineering of the action. If an action is in the FFRMS floodplain and its location is the only practicable alternative, then you may need the services of a professional engineer, architect, or other licensed design professional to determine how to minimize the impacts of flood and make the action resilient (e.g., elevation, flood-proofing and/or nature-based solutions), especially when dealing with critical actions.

Assistance

To contact the FEMA Regional Floodplain Management & Insurance FFRMS Point of Contact for assistance, e-mail FEMA at FEMA-FFRMS-SUPPORT-REQUEST@fema.dhs.gov



Project Location



June 22, 2024

Project Location



FFRMS Floodplain

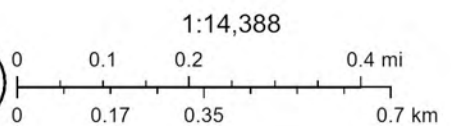

Map data provided by: Maxar, Esri Community Maps Contributors, Esri, TomTom, Garmin, Foursquare, SafeGraph, GeoTechnologies, Inc, METI/NASA, USGS, NPS, US Census Bureau, USFWS

Appendix 2:
Photos of existing site conditions

Econo Energy Project

Project ID: IPGM-00375

Address: State Road PR-3, Int. PR 9959, Km. 15.21 Bo. Canovanillas, Canóvanas, PR. 00729

Coordinates: 18.373613° -65.906549°

Photos of existing site conditions



Photo showing the level of the facility compared to the level of the wetland.



Photo taken from the facility rooftop showing the location of the wetland versus the project area.



Rooftop where PV panels will be installed



Photo showing the areas where Liquefied Natural Gas (LNG) tank and equipment and drying beds. will be installed



Utilities area showing area where the new equipment and control room will be located.



Area for control room, Gas-powered generator, Battery Energy Storage System, evaporator, buffer tank and cooling tower

Ground-level photo showing the area next to the building where the existing emergency-power generator units are located and where new equipment will be located.



Area for Liquefied Natural Gas tank and auxiliary equipment

Ground-level photo showing the area where the Photo showing the area where Liquefied Natural Gas (LNG) tank and its equipment will be installed.

Appendix 3:
Appraisal Report 2021

APPRAISAL REPORT



**SUPERMERCADOS ECONO, INC./RE: 94236
"AS-IS" & "AS-COMPLETED"
ECONO DISTRIBUTION WAREHOUSE
SOUTH OF ROAD PR-3, KM 16.2
CANOVANILLAS WARD
CANÓVANAS, PUERTO RICO**

Prepared For:

Ms. Nellie M. Ramírez Vázquez
Supervisor Appraisal Ordering
Banco Popular de Puerto Rico
PO Box 362708
San Juan PR, 00936-2708

Prepared By:

Juan José Jiménez, MAI
Federal Certified General Appraiser
State Certified Professional Appraiser

Luis P. Matos Colón
Federal Certified General Appraiser
State Certified Professional Appraiser

Effective Date of Appraisal:

May 12, 2021 (*As-Is*)
August 1, 2021 (*As-Completed*)

Date of Report:

June 1, 2021



June 1, 2021

Ms. Nellie M. Ramírez Vázquez
Supervisor Appraisal Ordering
Banco Popular de Puerto Rico
PO Box 362708
San Juan PR, 00936-2708

Dear Ms. Ramírez Vázquez:

In accordance with your request, we appraised the recently built Econo Distribution Warehouse, located south of Road PR-3, Km 16.2, within the Canovanillas Ward of Canóvanas, Puerto Rico. As part of the development of subject property a new intersection at Road PR-3 was built fronting the subject property, which allows access to the subject from any direction of Road PR-3, plus direct connection of subject property with Road PR-9959.

Subject location and accessibility allow connection to Expressway PR-66 at less than three minutes driving time, which is the main expressway of the region and allows quicker connection to the San Juan Metropolitan Region.

As requested, the valuation carried out herein involves the valuation of the subject property in its "As-Is" & "As-Completed" scenarios. The "As-Is" scenario refers to a 311,346.80 square meter site, improved with a recently built distribution warehouse with 404,660 sq. ft. total gross building area, designed for single-tenant/owner occupancy and with site area left prepared for future expansion of the warehouse space.

Property amenities include floor insulation system at cooler warehouse space, LED lighting fixtures with motion sensors, energy efficient cooler system, energy power substation, trailers parking area, wet sprinkler system, dock height floors, 400 employees parking spaces, 250 truck/trailer parking spaces, fire water cistern, potable water cistern and emergency power generator, among other components. The existing improvements were recently completed, and they were found in as-new condition.

The property is also equipped with an hydrogen energy generator plant that serves to supply the fuel cell forklifts, a retention pond, waste water treatment plant, perimeter fence and two guardhouse areas. The property improvements were designed and built to allow the facilities to apply for a Free Trade Zone designation.

The "As-Completed" scenario involves completion of the project, which according to owner representative, there is less than 10% of project needing to be completed (currently on final punch list phase).

After personal inspection of the subject property, analysis of the property documents and a thorough investigation and analysis of the factors affecting value, we concluded that the market value for the fee simple interest in the subject property, in its "as is" condition and subject to the extraordinary assumptions listed in the report and as of May 12, 2021, was:

\$81,900,000.00
(EIGHTY-ONE MILLION NINE HUNDRED THOUSAND DOLLARS)

Ms. Nellie M. Ramírez Vázquez, Banco Popular de Puerto Rico
RE: Proposed Econo Distribution Warehouse, South of Road PR-3, Km 16.2
Canovanillas Ward, Canóvanas, Puerto Rico

June 1, 2021

Page 2

Based on our inspection of the subject property and after analysis of the proposed project as detailed in the documents and information furnished by the owner of the property, we estimated the completion date to be August 1, 2021. Therefore, the prospective market value for the fee simple interest in the proposed subject property under the "As-Completed" scenario; is expected to be:

\$82,600,000.00
(EIGHTY-TWO MILLION SIX HUNDRED THOUSAND DOLLARS)

Possession of this report, or a copy thereof, does not carry with it the right of publication. This report may not be used for any purpose by any person other than the party to whom it is addressed without our written consent. We are not responsible for unauthorized use of this report, and no one, except the client, is allowed to use it or its findings for decision-making. We accept no responsibility for use of this report by any person or entity other than the client, or for any other intended use other than the one stated in the report.

This report includes proprietary and confidential information. As such, the client agrees not to distribute copies of this report without our prior written consent and recognizes that disclosure of this report may give rise to irreparable damages. Accordingly, in the event of a breach of confidentiality, we shall be entitled to present an injunction restraining the disclosure of the report and to pursue any other remedies available for such breach of confidentiality.

This appraisal report contains information considered relevant to the fee simple interest of the subject property and data and methods analyzed in arriving at the value conclusion(s). This document complies with the Uniform Standards of Professional Appraisal Practice of the Appraisal Foundation, the Code of Ethics of the Appraisal Institute, and conforms to appraisal regulations set forth under Title XI of The Financial Institutions Reform Recovery and Enforcement Act of 1989 (FIRREA).

Respectfully submitted,

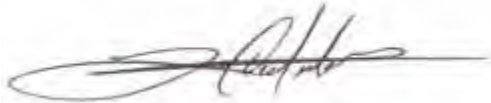

Luis P. Matos Colón
State License No. 1346EPA
Certified General Certificate No. 365CG



Juan José Jiménez, MAI
State License No. 691EPA
Certified General Certificate No. 166CG

PROPOSED ECONO DISTRIBUTION CENTER
SOUTH OF ROAD PR-3, KM 16.2
CANOVANILLAS WARD, CANÓVANAS, PUERTO RICO

TABLE OF CONTENT

MAPS	1
SUBJECT PHOTOS	4
EXECUTIVE SUMMARY	13
ASSUMPTIONS & HYPOTHETICAL CONDITIONS.....	14
SCOPE OF WORK	15
INTRODUCTION	17
PROPERTY ANALYSIS	21
PROPERTY TAX DATA AND ASSESSED VALUATION	43
NEIGHBORHOOD ANALYSIS	46
HIGHEST AND BEST USE.....	48
APPRAISAL PROCESS	51
INCOME CAPITALIZATION APPROACH; "AS-COMPLETED"	52
COST APPROACH; "AS-COMPLETED"	53
SALES COMPARISON APPROACH; "AS-COMPLETED"	64
RECONCILIATION AND FINAL VALUES ESTIMATE	65
"AS-IS" VALUE INDICATION	66
CERTIFICATION	67
GENERAL ASSUMPTIONS	68
GENERAL LIMITING CONDITIONS	69
ADDENDUM	70



PROPOSED ECONO DISTRIBUTION CENTER
SOUTH OF ROAD PR-3, KM 16.2
CANOVANILLAS WARD, CANÓVANAS, PUERTO RICO

MAPS



Aerial View

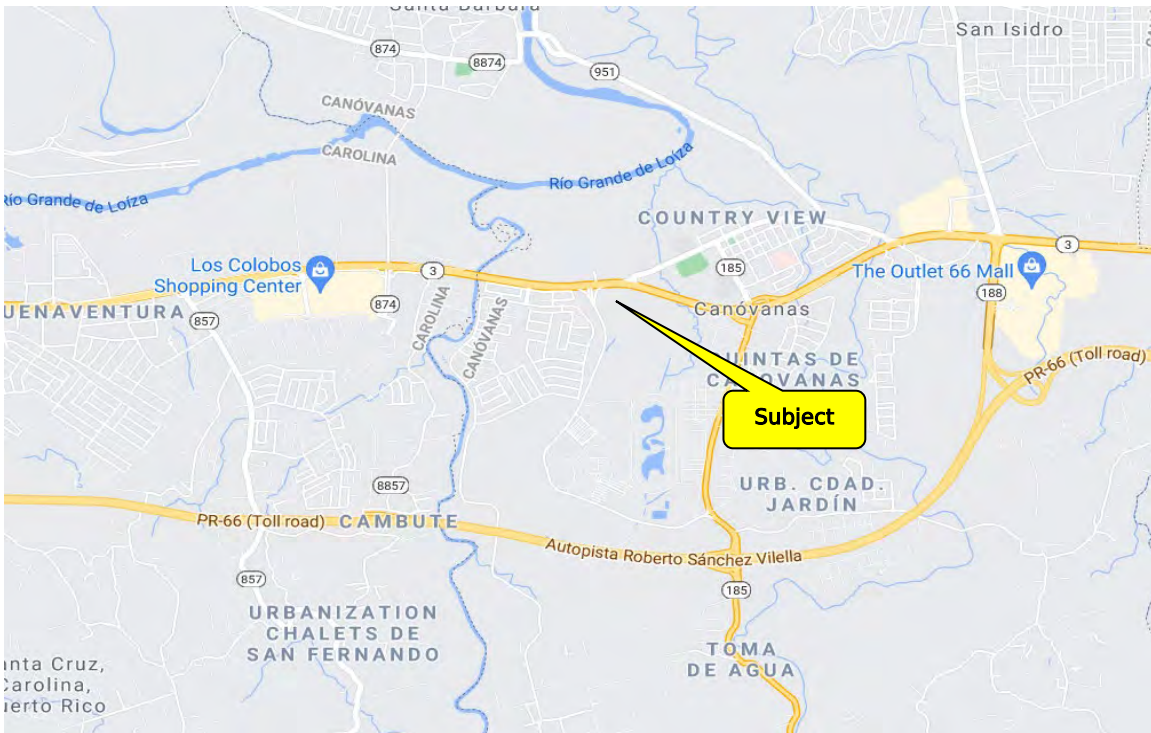

Road Map



**PROPOSED ECONO DISTRIBUTION CENTER
SOUTH OF ROAD PR-3, KM 16.2
CANOVANILLAS WARD, CANÓVANAS, PUERTO RICO**



Road PR-3 going east with subject property to the right



Road PR-3 going east with subject property to the left



**PROPOSED ECONO DISTRIBUTION CENTER
SOUTH OF ROAD PR-3, KM 16.2
CANOVANILLAS WARD, CANÓVANAS, PUERTO RICO**



Subject View from Road PR-3



PROPOSED ECONO DISTRIBUTION CENTER
SOUTH OF ROAD PR-3, KM 16.2
CANOVANILLAS WARD, CANÓVANAS, PUERTO RICO

SUBJECT PHOTOS

Exterior Photos



PROPOSED ECONO DISTRIBUTION CENTER
SOUTH OF ROAD PR-3, KM 16.2
CANOVANILLAS WARD, CANÓVANAS, PUERTO RICO



PROPOSED ECONO DISTRIBUTION CENTER
SOUTH OF ROAD PR-3, KM 16.2
CANOVANILLAS WARD, CANÓVANAS, PUERTO RICO



**PROPOSED ECONO DISTRIBUTION CENTER
SOUTH OF ROAD PR-3, KM 16.2
CANOVANILLAS WARD, CANÓVANAS, PUERTO RICO**



PROPOSED ECONO DISTRIBUTION CENTER
SOUTH OF ROAD PR-3, KM 16.2
CANOVANILLAS WARD, CANÓVANAS, PUERTO RICO

Interior Photos

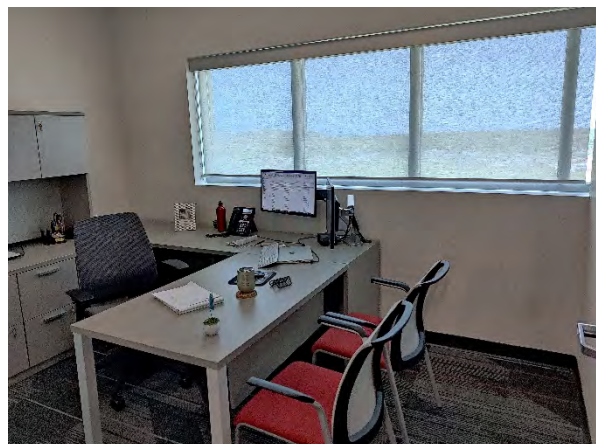
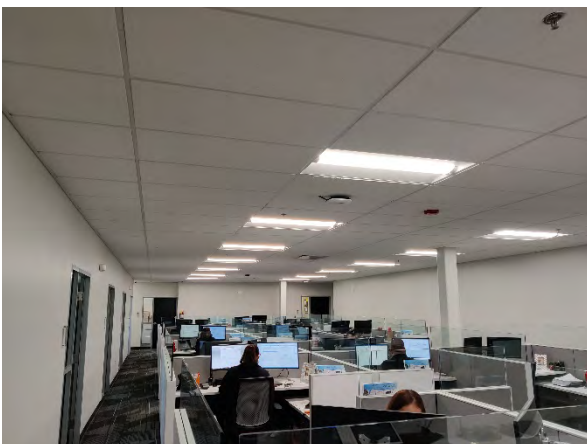

PROPOSED ECONO DISTRIBUTION CENTER
SOUTH OF ROAD PR-3, KM 16.2
CANOVANILLAS WARD, CANÓVANAS, PUERTO RICO

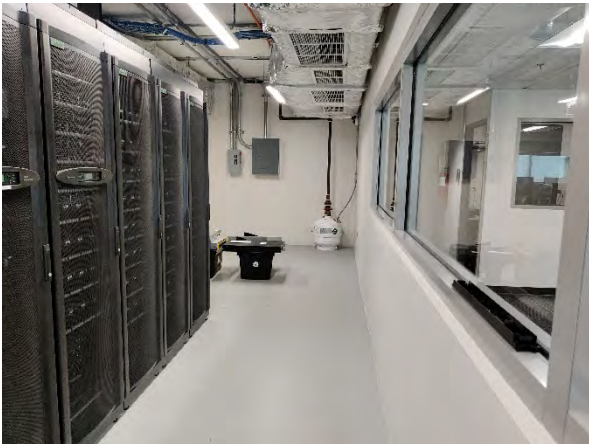
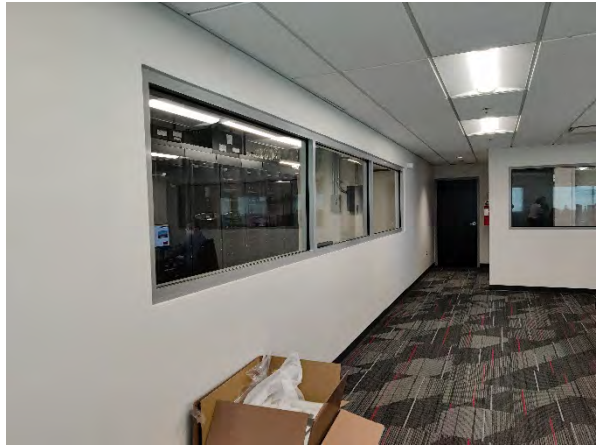

PROPOSED ECONO DISTRIBUTION CENTER
SOUTH OF ROAD PR-3, KM 16.2
CANOVANILLAS WARD, CANÓVANAS, PUERTO RICO



PROPOSED ECONO DISTRIBUTION CENTER
SOUTH OF ROAD PR-3, KM 16.2
CANOVANILLAS WARD, CANÓVANAS, PUERTO RICO

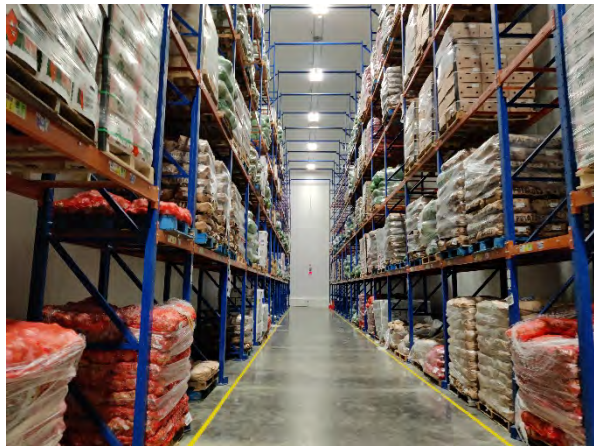
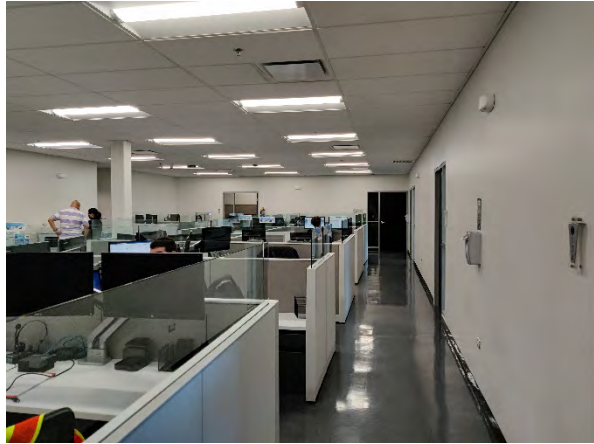

PROPOSED ECONO DISTRIBUTION CENTER
SOUTH OF ROAD PR-3, KM 16.2
CANOVANILLAS WARD, CANÓVANAS, PUERTO RICO

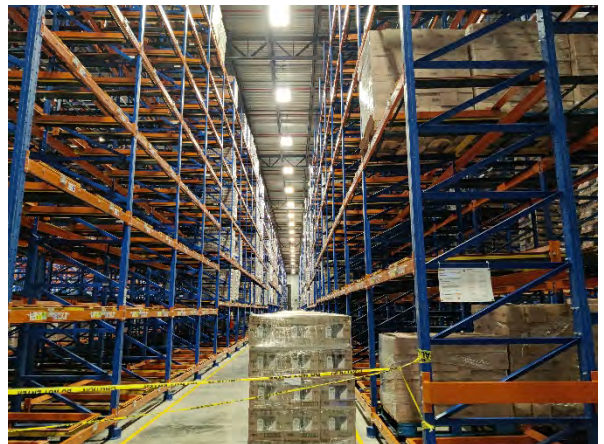
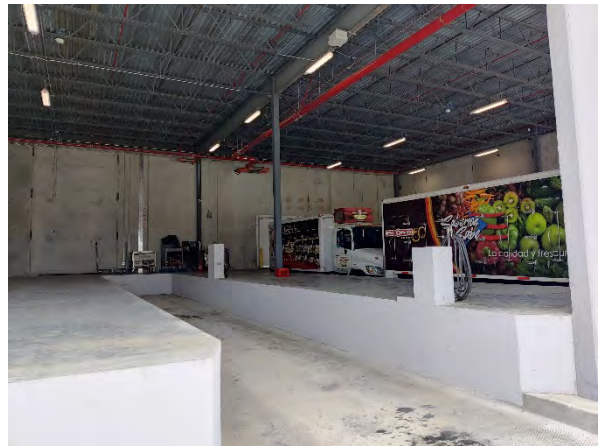
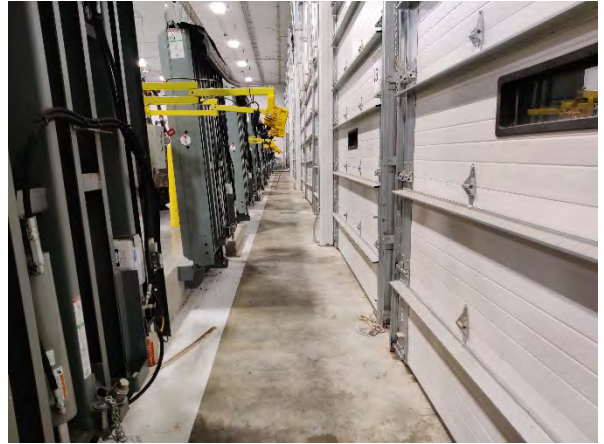
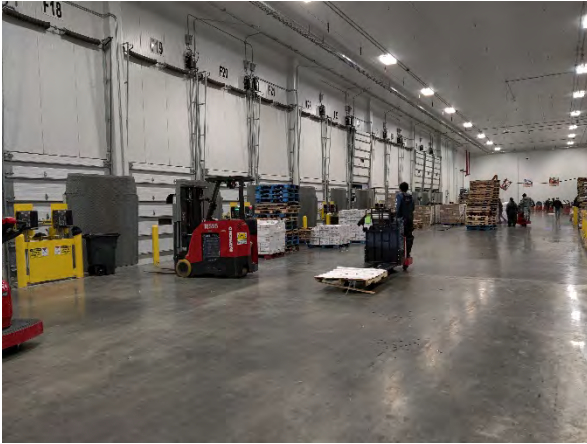

**PROPOSED ECONO DISTRIBUTION CENTER
SOUTH OF ROAD PR-3, KM 16.2
CANOVANILLAS WARD, CANÓVANAS, PUERTO RICO**

EXECUTIVE SUMMARY

Property Name	Econo Distribution Warehouse
Location	South of Road PR-6, Km 16.2, Canovanillas Ward, Canóvanas, Puerto Rico
Property Owner	Supermercados Econo, Inc.
Site Area	79.22 cuerdas, equivalent to 311,346.8 square meters
Description	Distribution Center, with dry storage warehouse, administrative offices and cold storage warehouse space. The property has a gross building area of 404,660 sq. ft. and was designed for single-tenant/owner occupancy.
Proposed Scenario	Completion of the existing improvements which according to owner representatives, it has less than 10% to achieve project completion.
Property Rights Appraised	Fee simple Interest
Effective Date of Value	May 12, 2021 <i>(As-Is)</i> August 1, 2021 <i>(As-Completed)</i>
“As Is” Value Conclusion	\$81,900,000.00
“As Completed” Value Conclusion	\$82,600,000.00

Important Assumptions or Conditions

1. All the information provided by the client and owner is assumed correct. Information provided include pages of land area, project cost, work & amount needed to complete project, capacity of machineries/equipments, project commencement date, building areas, property amenities and other project amenities.
2. We are assuming that the As-Completed scenario involving the completion of the proposed work will be completed by August 1, 2021 following the plans guidelines as furnished and detailed by property owner.
3. The property has additional land area that has site improvements (leveled and with utilities rough-in) that allow expansion of the warehouse areas.



ASSUMPTIONS & HYPOTHETICAL CONDITIONS

Extraordinary Assumption

An extraordinary assumption is defined by Uniform Standards of Professional Appraisal Practice (USPAP) 2020-2021 as “an assumption, directly related to a specific assignment, which, if found to be false, could alter the appraiser's opinions or conclusions. Extraordinary assumptions presume as fact otherwise uncertain information about physical, legal, or economic characteristics of the subject property; or about conditions external to the property such as market conditions or trends; or about the integrity of data used in an analysis.”

The following extraordinary assumptions were used in this report:

- All the information provided by the client and owner is assumed correct. Information provided include pages of land area, project cost, work & amount needed to complete project, capacity of machineries/equipments, project commencement date, building areas, property amenities and other project amenities.
- We are assuming that the As-Completed scenario involving the completion of the proposed work will be completed by August 1, 2021 following the plans guidelines as furnished and detailed by property owner.
- That the subject property has use permit and will obtain use permit for the proposed improvements.

Any variation from the extraordinary assumption(s) listed above could affect the opinion(s) of value reported.

Hypothetical Conditions

A hypothetical condition is defined by USPAP 2020-2021 as “that which is contrary to what exists but is supposed for the purpose of analysis. Hypothetical conditions assume conditions contrary to known facts about physical, legal, or economic characteristics of the subject property; or about conditions external to the property, such as market conditions or trends; or about the integrity of data used in an analysis”.

No hypothetical condition was used in the preparation of this report.



**PROPOSED ECONO DISTRIBUTION CENTER
SOUTH OF ROAD PR-3, KM 16.2
CANOVANILLAS WARD, CANÓVANAS, PUERTO RICO**

SCOPE OF WORK

The purpose of this appraisal was to form opinions of market value for the fee simple interest in the subject property, under the “As-Is” & “As-Completed” scenarios/condition, and as of the effective dates. We visited the subject property on May 12, 2021.

Identification of Property Characteristics

The property subject of this appraisal is located south of Road PR-3, Km 16.2, within the Canovanillas Ward of Canóvanas, Puerto Rico. As part of subject proposed project, an intersection is being built at Road PR-3, fronting the subject property. This new intersection, with traffic light, will allow direct access to the subject from any direction at Road PR-3, and also allows access from subject property towards Road PR-9959.

As requested, we are providing indications of value for the fee simple interest in the subject property under two scenarios, “As-Is” and “As-Completed”. Subject refers to distribution warehouse with dry storage warehouse area, administrative offices, and cold storage warehouse space. The property has a total gross building area of 404,660 sq. ft. and it was designed for single-tenant/owner occupancy.

The “As-Completed” scenario involves completion of proposed project which according to owner representative, it has less than 10% of project remaining to be completed (final punch list phase). Zoning and flood zone characteristics were identified by examination of the appropriate maps. Other relevant characteristics for the property were identified from visual inspection and from other reliable sources.

Property Inspection

In developing the opinions of value presented in this report, we visited the subject property in multiple occasions. The most recent visit was carried out on May 12, 2021.

Physical and Economic Factors

The property’s current physical and legal conditions, background, and history were researched with all due diligence expected of a professional real estate appraiser in the course of performing appraisal services. The legal interests, easements, covenants, restrictions, and other legal aspects were researched using the appropriate sources. The subject market area was examined to determine the demand for and marketability of the property. In developing the opinions of value presented in this report, we reviewed a series of documents from the client and owner which included:

- Pages of architectural plans
- Purchase Deed
- Land Survey
- Summary of capacities and or efficiencies of equipments & machineries installed at the property.
- Time of project completion, including time need to completed project.
- Project Cost Breakdown, including amount already invested and project master budget.

The property’s current physical and legal conditions, background, and history were researched with all due diligence expected of a professional real estate appraiser in the course of



**PROPOSED ECONO DISTRIBUTION CENTER
SOUTH OF ROAD PR-3, KM 16.2
CANOVANILLAS WARD, CANÓVANAS, PUERTO RICO**

performing appraisal services. The legal interests, easements, covenants, restrictions, and other legal aspects were researched using the appropriate sources. The subject market area was examined to determine the demand for and marketability of the property. The search included the subject municipality and other similar/competitive municipalities.

Approaches Developed

Considering the physical characteristics of the subject property, the most reliable valuation approach for this assignment is the cost approach. Because of lack of recent sales and rental that could be considered comparable in size, use, condition, location and quality of construction, the sales comparison and cost approaches were not developed.

Analysis Applied to Arrive at Opinions and Conclusions

For the development of the Cost Approach, we obtained information on site transactions that are similar in terms of date of sale, size, location, etc. We verified the information by confirming that the data be factually accurate and that the transactions reflect arm's-length market considerations.

The Replacement Cost New of the subject proposed improvements was estimated based on information furnished by the Marshall and Swift Valuation Service, project cost furnished by the owner of the property and other cost sources. After considering the applicable depreciation (based on the age life method; if any), the value of the site was added to the depreciated cost figure of the improvements to obtain the indication of value.

Reconciliation

The last step was to reconcile the analyses performed and to form our opinion of market value for the fee simple interest in the subject property, in its "As-Is" and "As-Completed" scenarios/condition; as of May 12, 2021, and to form our opinion of prospective market value as of August 1, 2021, and subject to the extraordinary assumptions listed in this report.



**PROPOSED ECONO DISTRIBUTION CENTER
SOUTH OF ROAD PR-3, KM 16.2
CANOVANILLAS WARD, CANÓVANAS, PUERTO RICO**

INTRODUCTION

Identification of the Property

The property subject of this appraisal refers to the new Econo Distribution Warehouse, located south of Road PR-3, Km 16.2, within the Canovanillas Ward of Canóvanas, Puerto Rico. Subject fronts a new intersection built at Road PR-3, which will allow direct access to subject property from any direct in Road PR-3, plus access to/from Road PR-9959. As requested, the property will be valued under the "As-Is" and "As-Completed" scenarios.

Owner

Supermercados Econo, Inc.

Client

Banco Popular de Puerto Rico

Effective Date of Value Estimate

"As-Is" Scenario- May 12, 2021

"As-Completed" Scenario- August 1, 2021

Intended Use and Users of the Appraisal

Intended Use: Commercial Credit Administration.

Intended Users: The client, Banco Popular de Puerto Rico (Banco Popular de Puerto Rico reserves the right to use the report for purposes of syndication with other financial institutions or securitization).

Type of Report

Appraisal Report

Date of the Report

June 1, 2021

Purpose of the Appraisal

The purpose of this appraisal was to form our opinion of market value for the fee simple interest in the subject property and also entails a prospective value indication of the subject property under the "As-Completed" scenario.

Definition of Market Value

Market Value is defined in the December 2, 2010 Interagency Appraisal and Evaluation Guidelines as follows:

"Market value means the most probable price which a property should bring in a competitive and open market under all conditions requisite to a fair sale, the buyer and the seller each acting prudently and knowledgeably, and assuming the price is not affected by undue stimulus. Implicit in this definition are the consummation of a sale as of a specified date and the passing of title from seller to buyer under conditions whereby:



**PROPOSED ECONO DISTRIBUTION CENTER
SOUTH OF ROAD PR-3, KM 16.2
CANOVANILLAS WARD, CANÓVANAS, PUERTO RICO**

- Buyer and seller are typically motivated;
- Both parties are well informed or well advised and acting in what they consider their own best interests;
- A reasonable time is allowed for exposure in the open market;
- Payment is made in terms of cash in U.S. dollars or in terms of financial arrangements comparable thereto; and
- The price represents the normal consideration for the property sold unaffected by special or creative financing or sales concessions granted by anyone associated with the sale."

Additional Definitions¹

Net Lease

A lease in which the landlord passes on all expenses to the tenant.

Gross Lease

A lease in which the landlord receives stipulated rent and is obligated to pay all of the property's operating and fixed expenses; also called *full-service lease*.

Modified Gross Lease

A lease in which the landlord receives stipulated rent and is obligated to pay some, but not all, of the property's operating and fixed expenses. Since assignment of expenses varies among modified gross leases, expense responsibility must always be specified. In some markets, a modified gross lease may be called a *double net lease*, *net net lease*, *partial net lease*, or *semi-gross lease*.

Common Area Maintenance (CAM)

The amount of money charged to tenants for their shares of maintaining a property's common areas. The charge that a tenant pays for shared services and facilities such as electricity, security, and maintenance of parking lots. The area maintained in common by all tenants, such as parking lots and common passages. The area is often defined in the lease and may or may not include all physical area to be paid for by all tenants. Items charged to common area maintenance may include cleaning services, parking lot sweeping and maintenance, garbage removal, security, and upkeep.

Leased Fee Interest

The ownership interest held by the lessor, which includes the right to receive the contract rent specified in the lease plus the reversionary right when the lease expires.

Fee Simple Estate

Absolute ownership unencumbered by any other interest or estate, subject only to the limitations imposed by the governmental powers of taxation, eminent domain, police power, and escheat.

Gross Building Area

Total floor area of building, excluding unenclosed areas, measured from exterior of the walls of the above-grade area. This includes mezzanines and basements if and when typically included in the market area of the type of property involved.

Rentable Area

For office or retail buildings, the tenant's pro rata portion of the entire office floor, excluding elements of the building that penetrate through the floor to areas below. The rentable area of

¹ The Dictionary of Real Estate Appraisal, Sixth Edition. Published by the Appraisal Institute on 2015.



**PROPOSED ECONO DISTRIBUTION CENTER
SOUTH OF ROAD PR-3, KM 16.2
CANOVANILLAS WARD, CANÓVANAS, PUERTO RICO**

a floor is computed by measuring to the inside finished surface of the dominant portion of the permanent building walls, excluding any major vertical penetrations of the floor. Alternatively, the amount of space on which the rent is based; calculated according to local practice.

As Is Market Value

The estimate of the market value of a real property in its current physical condition, use and zoning as of the appraisal date. (Interagency Appraisal and Evaluation Guidelines)

Stabilized Occupancy

A-The occupancy of a property that would be expected at a particular point in time, considering its relative competitive strength and supply and demand conditions at the time, and presuming it is priced at market rent and has had reasonable market exposure. A property is at stabilized occupancy when it is capturing its appropriate share of market demand.

B- An expression of the average or typical occupancy that would be expected for a property over a specified projection period or over its economic life.

Prospective Opinion of Value

A value opinion effective as of a specified future date. The term does not define a type of value. Instead, it identifies a value opinion as being effective at some specific future date. An opinion of value as of a prospective date is frequently sought in connection with projects that are proposed, under construction, or under conversion to a new use, or those that have not yet achieved sellout or a stabilized level of long-term occupancy.

Prospective Market Value; As Completed

Reflects the property's market value as of the time the property is expected to be completed.

Prospective Market Value; As Stabilized

Reflects the property's market value as of the time the property is projected to achieve stabilized occupancy.

Property Rights to be Valued

Fee simple interest

Value Terms

Value in this report is in terms of cash, U.S. dollars (\$)

Reasonable Exposure Time

Reasonable exposure time is one of a series of conditions in most market value definitions. Exposure time is defined as follows: the time a property remains on the market and the estimated length of time the property interest being appraised would have been offered on the market prior to the hypothetical consummation of a sale at market value on the effective date of the appraisal; a retrospective estimate based upon an analysis of past events assuming a competitive and open market.

Exposure time is always presumed to occur prior to the effective date of the appraisal. The overall concept of reasonable exposure encompasses not only adequate, sufficient and reasonable time but also adequate, sufficient and reasonable effort. Exposure time is different for various types of real estate and value ranges and under various market conditions.

After consultations with building owners and brokers familiar with similar properties, and analyzing the comparable transactions obtained, we concluded with a reasonable exposure time



**PROPOSED ECONO DISTRIBUTION CENTER
SOUTH OF ROAD PR-3, KM 16.2
CANOVANILLAS WARD, CANÓVANAS, PUERTO RICO**

of approximately **two (2) years**. This assumes an active and professional marketing plan would have been employed by the seller.

Ownership History of the Property

The Uniform Standards of Professional Appraisal Practice indicate that in developing a real property appraisal, an appraiser must consider and analyze any current agreement of sale, option, or listing of the property being appraised, if such information is available in the normal course of business. In addition, an appraiser must consider and analyze any prior sale of the property being appraised that occurred three (3) years before the effective date of appraisal.

Based on documents submitted by the client, there have not been any reported transaction of the subject property during the last three years, thus, there is no recent sales history to analyze. Moreover, we are not aware of any current agreement of sale or option of the subject property.

We are not responsible for any information referent to the legal title of the subject property and assume no liability in this respect. We do not represent ourselves as experts in title matters. Current title of the subject property should be verified with government authorities.



**PROPOSED ECONO DISTRIBUTION CENTER
SOUTH OF ROAD PR-3, KM 16.2
CANOVANILLAS WARD, CANÓVANAS, PUERTO RICO**

PROPERTY ANALYSIS

Location, Exposure, Frontage and Access

The subject property is located south of Road PR-3 at kilometer 16.2, within the Canovanillas Ward of Canóvanas, Puerto Rico. In terms of frontage and exposure, because of its size, subject enjoys ample exposure, frontage and access through Road PR-3. In fact, subject enjoys access by two different front areas, one for the trucks and other for regular vehicles. Subject above street level topography also allows subject to enjoy good exposure from Road PR-3. As part of proposed project, a new intersection on Road PR-3 was built fronting the subject property.



The new intersection will allow access to the subject property from any direction of Road PR-3, and will also allow direct connection between subject and Road PR-9959. In general, subject enjoys adequate frontage, exposure and access for its development into one of the legally permissible uses and in harmony with the neighborhood composition.

Subsoil and Drainage

Drainage of the property appears to be adequate with the site work carried out. As part of the drainage of the property, a retention pond was built next to a wetland area within the property, located towards the northeast section of the site. No subsoil studies were available for our review, but the condition of the site and building improvements did not reveal any adverse



**PROPOSED ECONO DISTRIBUTION CENTER
SOUTH OF ROAD PR-3, KM 16.2
CANOVANILLAS WARD, CANÓVANAS, PUERTO RICO**

conditions that might affect the marketability of the property. We assume no responsibility in this respect.

Legal Description and Land Area

Next is an image of the legal description of the subject lot.

----RÚSTICA: Parcela de terreno sita en el Barrio Canovanillas del término municipal de Canóvanas, antes, Loíza, Puerto Rico, con una cabida de SETENTA Y NUEVE CUERDAS CON DOSCIENTAS VEINTE MILÉSIMAS DE OTRA (79.22 CDAS.), equivalente a TREINTA Y UNA (31) HECTÁREAS, TRECE (13) ÁREAS, CUARENTA Y SEIS (46) CENTIÁREAS y OCHO (8) MILIÁREAS, o sea, TRESCIENTOS ONCE MIL TRESCIENTOS CUARENTA Y SEIS METROS CUADRADOS CON OCHO DÉCIMAS DE OTRO (311,346.8 M.C.). En lindes, por el NORTE, con la Carretera Estatal Número Tres (3), que conduce de Carolina a Río Grande; por el SUR, con la parcela segregada para traspasar a San Juan Racing Association, Inc.; por el ESTE, con terrenos de Canóvanas Industrial Development Corporation, separados en parte de la extensión de la colindancia por el nuevo cauce del Caño Bocaforma y con la parcela segregada para traspasar a San Juan Racing Association, Inc.; y por el OESTE, con la parcela segregada para traspasar a San Juan Racing Association, Inc. -----

According to the information provided, subject has a land area of 79.22 cuerdas, or 311,346.8 square meters. This land area was compared with a recent land survey furnished by owner representative and included below.



**PROPOSED ECONO DISTRIBUTION CENTER
SOUTH OF ROAD PR-3, KM 16.2
CANOVANILLAS WARD, CANÓVANAS, PUERTO RICO**

PARCEL-3						
COURSE	BEARING	DISTANCE	PT#	NORTHING	EASTING	DESCRIPTION
1-2	S 89° 07' 53"	W 93.9128	1	259783.4018	256023.9682	TO BE ESTABLISHED
2-3	S 40° 59' 02"	W 401.8681	2	259781.9781	255930.0662	TO BE ESTABLISHED
3-4	S 83° 01' 00"	W 316.7535	3	259478.6104	255666.5022	TO BE ESTABLISHED
4-5	N 20° 12' 32"	E 297.9510	4	259440.0988	255352.0985	TO BE ESTABLISHED
5-8	N 07° 45' 31"	W 271.2330	5	259719.7081	255455.0232	TO BE ESTABLISHED
CURVE	A=282.6785	DELTA=56° 49' 44"		T=154.1923	EXT=39.0373	
5-8	N 07° 45' 31"	W 271.2330	8	259989.6060	255418.2504	TO BE ESTABLISHED
RADIUS POINT		285.0009	6	259818.1588	255187.5668	RADIO-1
7-7	N 90° 00' 00"	C 0.0000	7	259957.1314	255436.3882	TO BE ESTABLISHED
7-8	N 29° 11' 04"	W 37.1965	8	259989.6060	255418.2504	TO BE ESTABLISHED
CURVE	A=84.3439	DELTA=30° 12' 12"		T=43.1765	EXT=5.7233	
9-11	N 07° 37' 03"	W 83.3707	11	260093.8781	255398.1391	TO BE ESTABLISHED
RADIUS POINT		160.0006	10	260073.0378	255556.7767	RADIO-2
11-12	N 07° 29' 03"	E 4.7556	12	260098.5932	255398.7585	TO BE ESTABLISHED
CURVE	A=61.8698	DELTA=47° 15' 54"		T=32.8174	EXT=6.8656	
12-14	N 31° 07' 00"	E 60.1304	14	260150.0718	255429.8328	TO BE ESTABLISHED
RADIUS POINT		75.0001	13	260088.8243	255473.1197	RADIO-3
14-15	N 61° 10' 13"	E 11.3853	15	260155.5618	255439.8070	PR-3 R. D. W.
15-16	N 85° 39' 40"	E 65.8605	16	260160.5445	255505.4787	PR-3 R. D. W.
16-17	N 02° 17' 19"	W 5.0000	17	260165.5405	255505.2790	PR-3 R. D. W.
17-18	N 87° 42' 40"	E 19.7000	18	260166.3273	255524.9633	PR-3 R. D. W.
18-19	S 85° 17' 20"	E 98.0000	19	260158.2782	255622.6322	PR-3 R. D. W.
19-20	S 07° 27' 08"	E 6.5424	20	260151.7911	255623.4808	PR-3 R. D. W.
20-21	S 11° 57' 12"	W 4.0006	21	260147.8772	255622.6522	PR-3 R. D. W.
21-22	S 76° 51' 43"	E 15.0017	22	260144.4674	255637.2612	PR-3 R. D. W.
22-23	S 73° 14' 34"	E 97.9979	23	260116.2131	255731.0977	PR-3 R. D. W.
23-24	S 70° 53' 20"	E 64.2948	24	260095.1630	255791.8490	PR-3 R. D. W.
24-25	S 19° 06' 41"	W 8.0243	25	260087.5810	255789.2218	PR-3 R. D. W.
25-26	S 70° 53' 20"	E 43.2242	26	260073.4292	255830.0637	PR-3 R. D. W.
26-27	S 70° 53' 21"	E 5.5157	27	260071.6234	255835.2755	PR-3 R. D. W.
27-28	N 19° 06' 40"	E 9.0535	28	260080.1779	255838.2396	PR-3 R. D. W.
28-29	S 70° 53' 20"	E 15.7134	29	260075.0334	255853.0870	PR-3 R. D. W.
29-30	S 70° 53' 20"	E 45.2866	30	260060.2064	255895.8776	PR-3 R. D. W.
30-31	S 19° 06' 40"	W 16.0000	31	260045.0882	255890.6392	TO BE ESTABLISHED
31-32	S 61° 36' 16"	E 99.8034	32	259997.6261	255978.4348	TO BE ESTABLISHED
32-33	S 55° 27' 11"	E 53.8041	33	259967.1149	256022.7512	TO BE ESTABLISHED
33-34	S 26° 40' 33"	E 47.9582	34	259924.2614	256044.2817	TO BE ESTABLISHED
CURVE	A=92.5864	DELTA=44° 12' 24"		T=48.7352	EXT=9.5188	
34-36	S 00° 05' 00"	E 90.3069	36	259833.9546	256044.4130	TO BE ESTABLISHED
RADIUS POINT		120.0002	35	259878.9463	255933.1665	RADIO-4
36-1	S 22° 01' 11"	W 54.5305	1	259783.4018	256023.9682	TO BE ESTABLISHED

Total Distance Traversed > 2447.0831
 AREA > 311366.0092 SQ. METERS = 79.2200 CUERDAS

The land survey provided states a total land area of 79.2200 cuerdas, which represents a difference of less than 5% with the land area stated in the legal description. Taking into consideration the slight difference, our land area for the subject property will be based on the legal description furnished by owner representative. For purpose of this report, the land area established in the legal description is assumed accurate.

Topography and Configuration

Based on inspection of the subject property, it has a variable topography, predominantly above street grade with Road PR-3, with level areas, rolling downward portions and slightly highly areas. As part of the project developed, considerable site work was carried out that included filling, grading, compacting and building a retention pond. Subject configuration is irregular, with narrower portion fronting Road PR-3 and having ample depth towards the south of the site. Based on the above characteristics, the subject site is considered completely functional for its current use.

Utilities and Services

The subject property has the basic utilities that are typical for urban areas. These include electricity, telecommunications and potable water. In the case of sewer system, subject is not connected to the public sewer system, but rather is equipped with a wastewater treatment plant for its sanitary system, and rain sewer system that connects with the retention pond.

**PROPOSED ECONO DISTRIBUTION CENTER
SOUTH OF ROAD PR-3, KM 16.2
CANOVANILLAS WARD, CANÓVANAS, PUERTO RICO**

For purpose of this report, it is assumed that subject has adequate sewer systems to support the operation of existing improvements. Garbage collection for commercial properties in the immediate area is commonly served by the municipalities. However, garbage pick-up in commercial properties is usually contracted with a private company.

Easements, Encroachments and Expropriations

The only apparent easements affecting the subject property are those necessary for the connection and maintenance of utilities. Yet, utilities easements are typical and in the case of subject's utilities easements, these are not considered to have a negative impact upon value. We do not assume responsibility in this respect. No adverse encroachments or contemplated expropriations are assumed for the subject property.

Environmental Impact

An environmental impact study has not been furnished for the preparation of this appraisal report. The value estimate contained herein could be affected by the results of an environmental impact study, research, investigation, and resulting government actions, if any.

Hazardous Materials

The presence of certain materials, such as asbestos, urea formaldehyde, radon gas, toxic waste and others can have a significant negative impact upon the value of unimproved and improved properties. We are not qualified to detect such substances or to certify if a site is contaminated. However, we did not find any visible indication of hazardous materials during our inspection of the subject property.

For purposes of this appraisal, it is assumed that there are no potential or existing pollutants in or on the property and that no contaminant has emanated from the subject to adjacent properties or bodies of water. The client is advised to seek the opinion of an environmental expert, if so desired.

Proximity to Nuisances, Hazards or Detrimental Conditions

In order to determine the proximity to nuisances, hazards or detrimental influences, we inspected the subject's immediate neighborhood. In this inspection, we found that the subject property is not located next to or nearby any nuisances, potential hazards or other visible detrimental conditions. No liability for any undetected nuisances, hazards or detrimental conditions.

Flood Zone Classification

Next are images of the Puerto Rico Planning Board Web Site for the subject general area.



**PROPOSED ECONO DISTRIBUTION CENTER
SOUTH OF ROAD PR-3, KM 16.2
CANOVANILLAS WARD, CANÓVANAS, PUERTO RICO**



Ubicación	
Catastro	117-000-003-01
Coordenadas Nad83	x: 255669.7712, y: 259806.7571 (Lat: 18.37295950, Lon: -65.90655476) Ver: Google Google Earth OpenStreet Tembl Waze
Area Aprox. (m.c.)	356277.1557
Municipio	Canóvanas
Barrio	Canóvanas (50.9%), Barrio Pueblo (49.1%)
Características Ambientales	
Zona Inundabilidad	X
Zona Inund. Advisory	A (14.5%) , X 0.2% ACF (0.2%)
Panel Inundabilidad	72000C0395J , 72000C0760J
Floodway	
Suelo (NRCS)	CbF2 (42.7%) , MaB (25.6%) , MaD2 () MaC2 (10.5%) , G.P. (5.4%) , Co (1.4%)

Even though the Puerto Rico Planning Board established a different lot size for the subject property, their size information commonly differs from what is established in the legal deeds of the properties. In the case at hand and based on the documents submitted by the client, we will assume that the data provided in the documents furnished is accurate.

According to the Planning Board Web Site, subject can be identified in the FIRM for the Commonwealth of Puerto Rico, Map Number 72000C0395J and 72000C0760J, and is located within unshaded Zone X area. Based on the FEMA flood zone definitions section in their web page, the "X" unshaded flood classification is an "Area of minimal flood hazard, usually depicted on FIRMs as above the 500-year flood level and protected by levee from 100-year flood". In general, subject's flood classification should not affect its potential development into one of the legally permissible uses.

Improvements Details; "As-Is"

Subject refers to an industrial property design for single occupancy with areas used as distribution warehouse, with areas of cooler warehouse, freezer warehouse, administrative offices, and cool docks, among other supporting areas. Next is the table summarizing the areas of the subject building, based on pages of architectural plans furnished. This area summary table is followed by an area analysis.

SUMMARY OF SUBJECT AREAS	
Space	Area (in Sq.Ft.)
Administrative Offices	
First Floor	22,404.00
Second Floor	14,526.00
Third Floor	13,502.00
Total Administrative Office Area	50,432.00
Dry Warehouse	214,616.03
Cooler/Freezer Warehouse	139,612.00
Total Gross Building Area	404,660.03



**PROPOSED ECONO DISTRIBUTION CENTER
SOUTH OF ROAD PR-3, KM 16.2
CANOVANILLAS WARD, CANÓVANAS, PUERTO RICO**

AREA ANALYSIS; "As-Is"

Space ID	Use	Area (in Sq.Ft.)	As a % of Total GBA
Total Gross Building Area		404,660	100.00%
Use Analysis			
Dry Storage Warehouse with Dock Area		214,616	53.04%
Cold Storage Warehouse with Dock Area		91,533	22.62%
Freezer Storage Warehouse		48,079	11.88%
Office Improved Areas		50,432	12.46%
Loading Doors Analysis			
Total Gross Building Area		404,660	
Total Loading Doors		72	
Loading Doors Ratio (1;10,000 sq.ft. of GBA)		1.78	
Occupancy Analysis			
Land Area (Sq. Mts.)		311,347	
Foot Print (Sq. Ft.)		376,632	
Site Coverage Ratio		11%	(Footprint/Land Area)
Land-to-Building Ratio (#:1)		8.28	(Land Area/GBA)

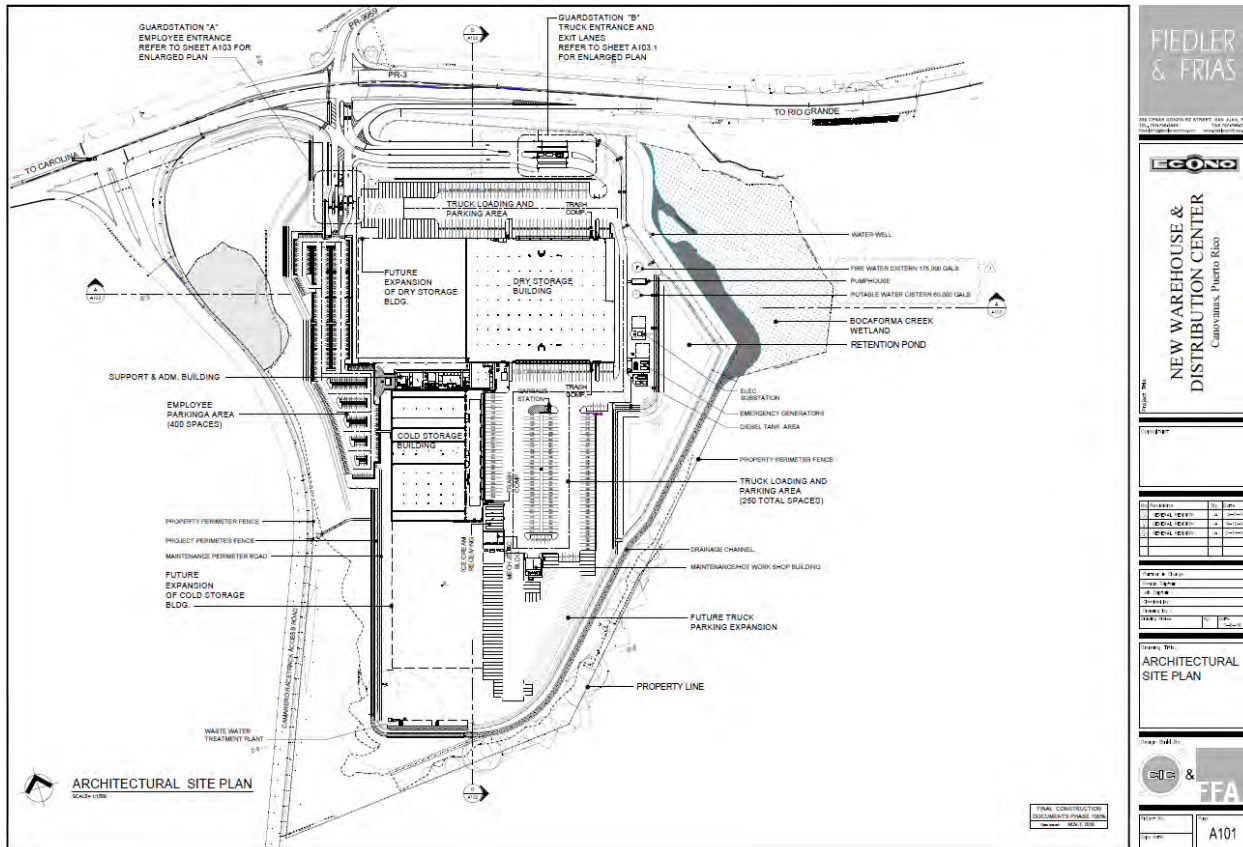

FIEDLER & FRIAS

ECONO

NEW WAREHOUSE & DISTRIBUTION CENTER
Canovanillas, Puerto Rico

ARCHITECTURAL SITE PLAN

SCALE 1/8" = 1'-0"

DATE: 06/01/2021

PROJECT NO: A101



**PROPOSED ECONO DISTRIBUTION CENTER
SOUTH OF ROAD PR-3, KM 16.2
CANOVANILLAS WARD, CANÓVANAS, PUERTO RICO**

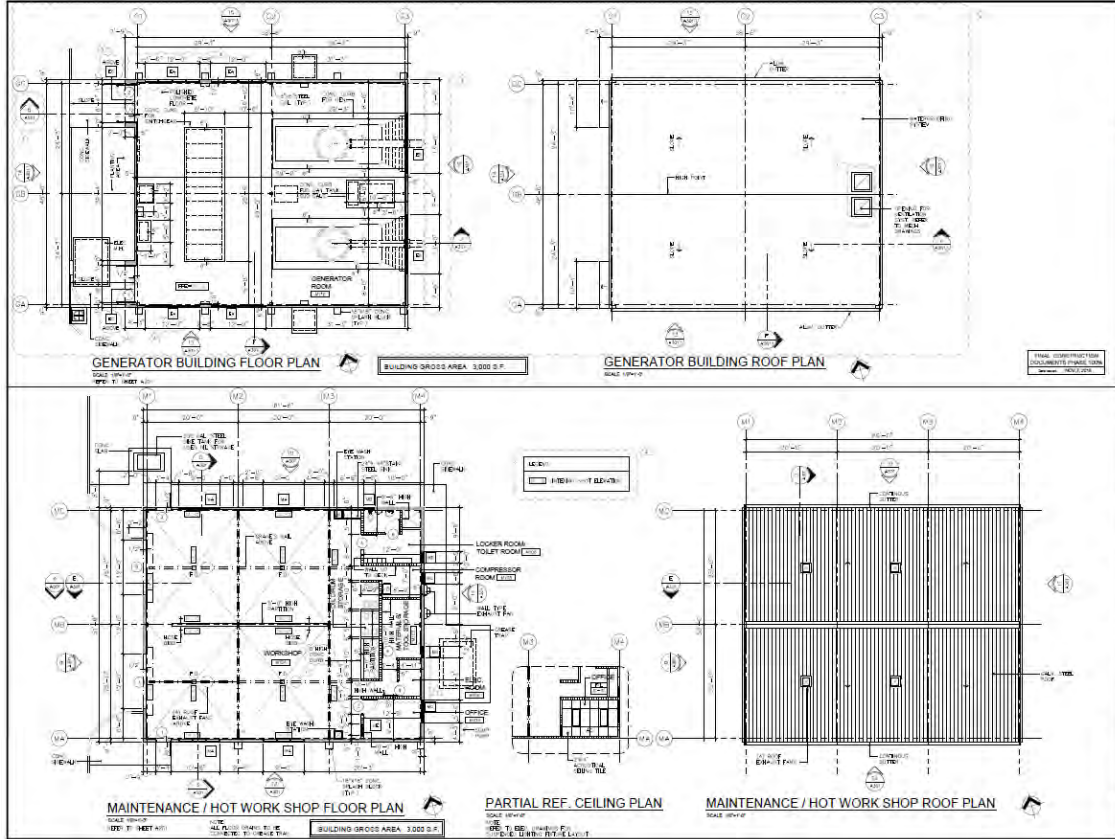

FIEDLER & FRIAS

ECONO

**NEW WAREHOUSE &
DISTRIBUTION CENTER**
Canovanillas, Puerto Rico

NO.	DESCRIPTION	DATE
1	ISSUED FOR PERMITS	05/11/2021
2	ISSUED FOR PERMITS	05/11/2021
3	ISSUED FOR PERMITS	05/11/2021
4	ISSUED FOR PERMITS	05/11/2021

Drawn By: **MISCELLANEOUS BUILDINGS FLOOR PLANS**

Checked By: **FFA**

Sheet No: **A202.1**



**PROPOSED ECONO DISTRIBUTION CENTER
SOUTH OF ROAD PR-3, KM 16.2
CANOVANILLAS WARD, CANÓVANAS, PUERTO RICO**

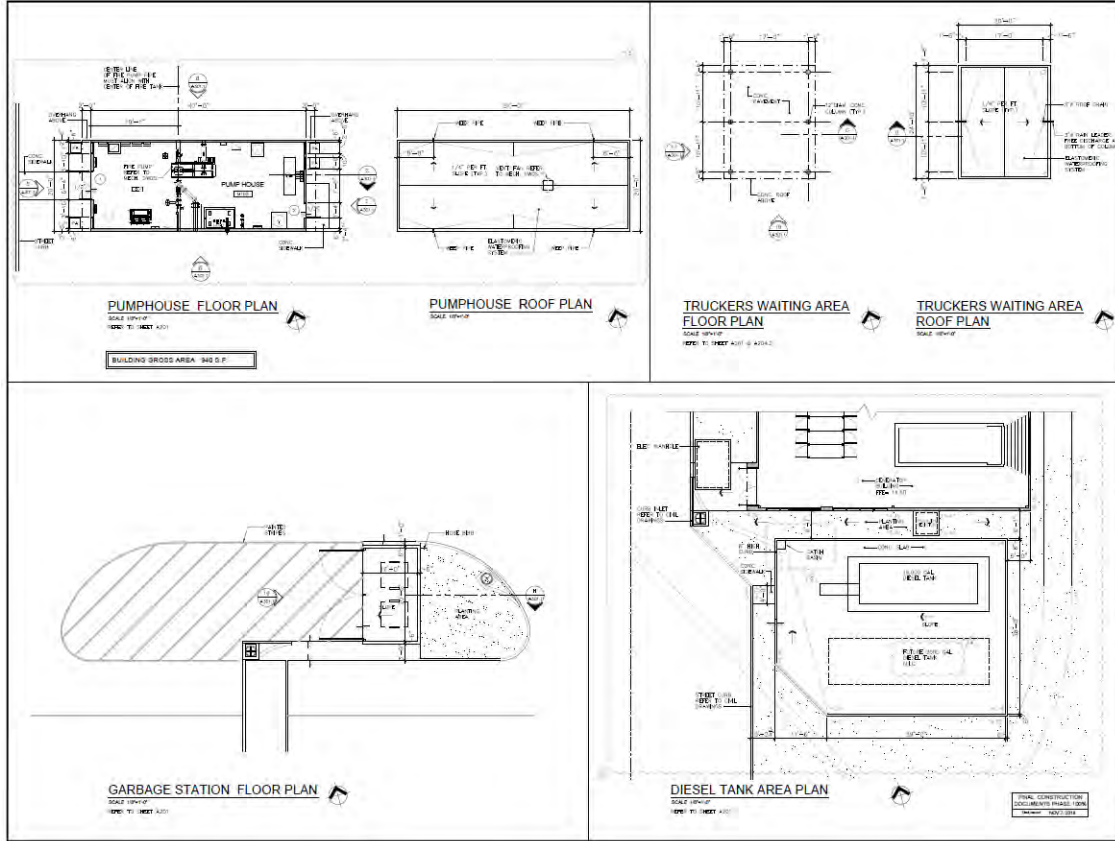

FIEDLER & FRIAS

ECONO

NEW WAREHOUSE & DISTRIBUTION CENTER
Canovanillas, Puerto Rico

NO.	DESCRIPTION	DATE
1	ISSUED FOR PERMITS	11/16/21
2	ISSUED FOR PERMITS	11/16/21
3	ISSUED FOR PERMITS	11/16/21
4	ISSUED FOR PERMITS	11/16/21
5	ISSUED FOR PERMITS	11/16/21

PHASE: 0000
DATE: 11/16/21

MISCELLANEOUS BUILDINGS FLOOR PLANS

DATE: 11/16/21

FFA

A202.2



**PROPOSED ECONO DISTRIBUTION CENTER
SOUTH OF ROAD PR-3, KM 16.2
CANOVANILLAS WARD, CANÓVANAS, PUERTO RICO**

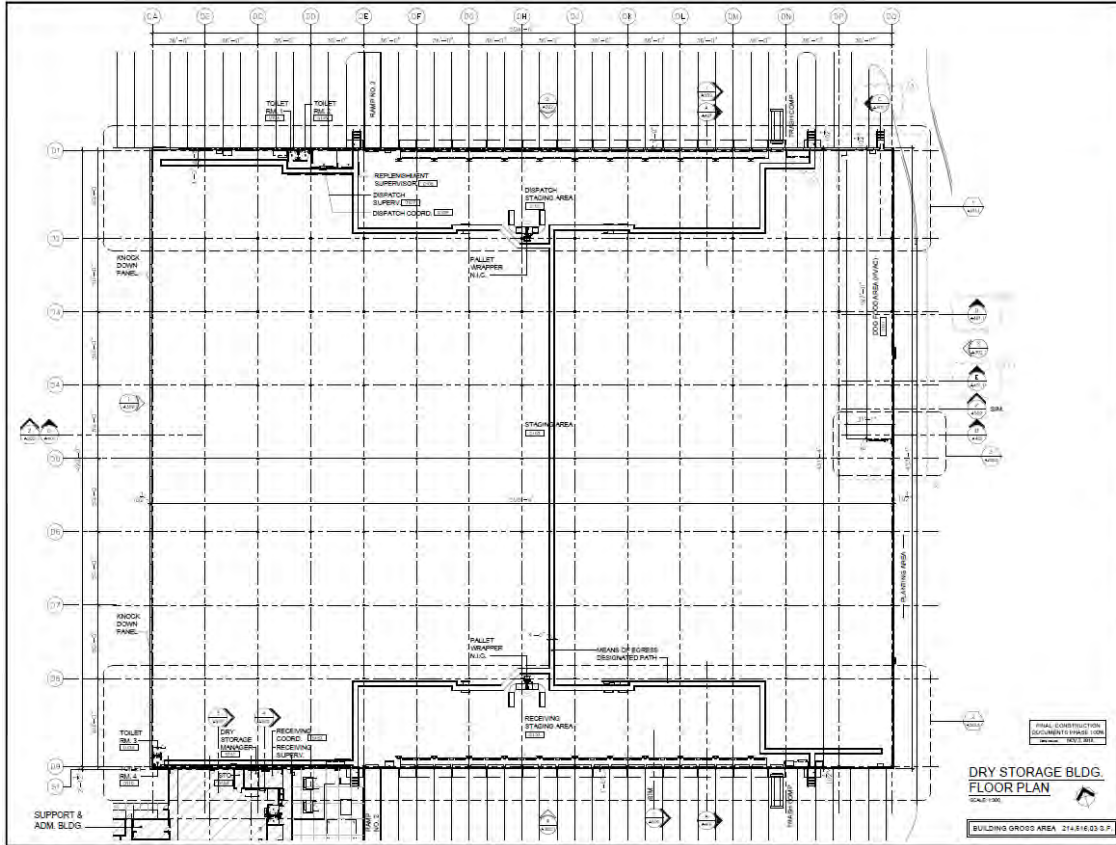

FIEDLER & FRIAS
REGISTERED PROFESSIONAL ARCHITECTS AND ENGINEERS
10000 Highway 100, Suite 100, San Juan, P.R. 00925

ECONO

**NEW WAREHOUSE &
DISTRIBUTION CENTER**
Canovanillas, Puerto Rico

Project No. _____

NO.	REVISION	DATE	BY	CHKD.

Scale: 1/8" = 1'-0"

Sheet No. **08**

DRY STORAGE BUILDING

FLOOR PLAN

Scale: 1/8" = 1'-0"

Final Construction Documents (Sheet 08) - 2021-05-28

**DRY STORAGE BLDG.
FLOOR PLAN**
SCALE: 1/8" = 1'-0"

BUILDING GROSS AREA: 214,816.22 S.F.

F.F.A. & F.F.A.

Sheet No. **A203**



**PROPOSED ECONO DISTRIBUTION CENTER
SOUTH OF ROAD PR-3, KM 16.2
CANOVANILLAS WARD, CANÓVANAS, PUERTO RICO**

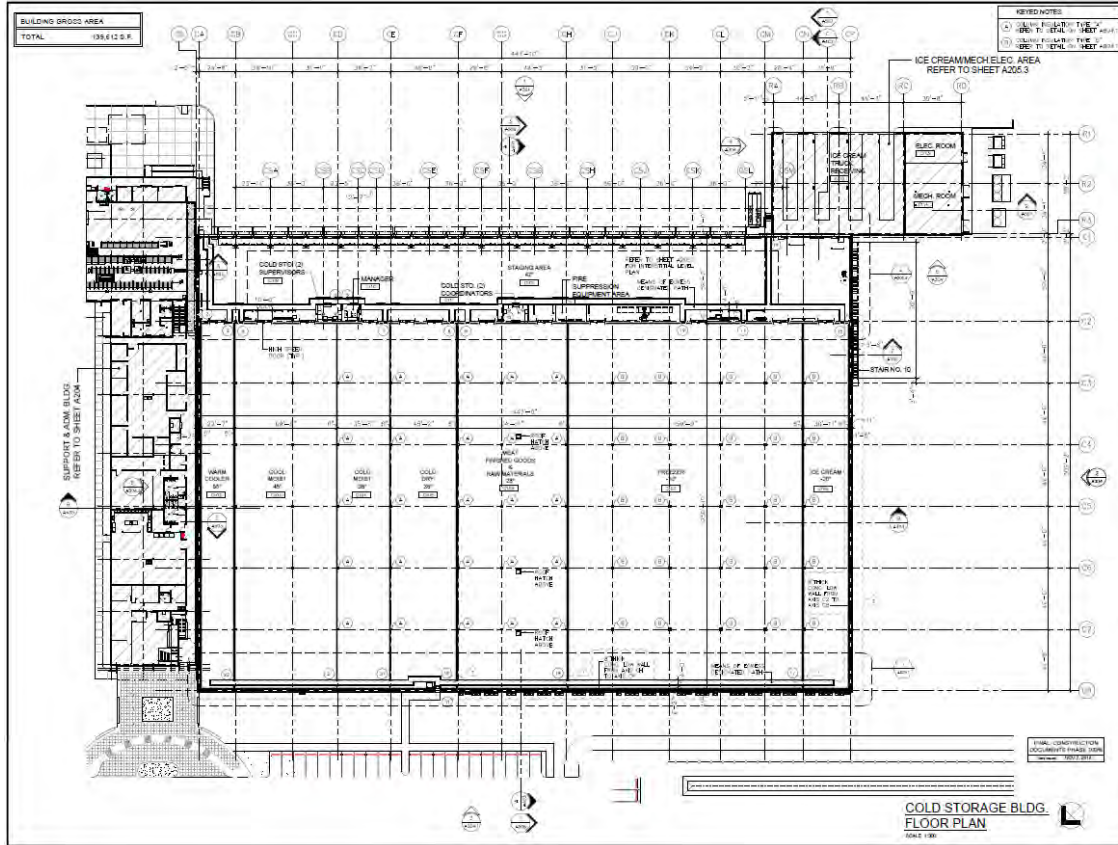

FIEDLER & FRIAS

ECONO

**NEW WAREHOUSE &
DISTRIBUTION CENTER**
Canovanillas Puerto Rico

FLOOR PLAN

A205



**PROPOSED ECONO DISTRIBUTION CENTER
SOUTH OF ROAD PR-3, KM 16.2
CANOVANILLAS WARD, CANÓVANAS, PUERTO RICO**

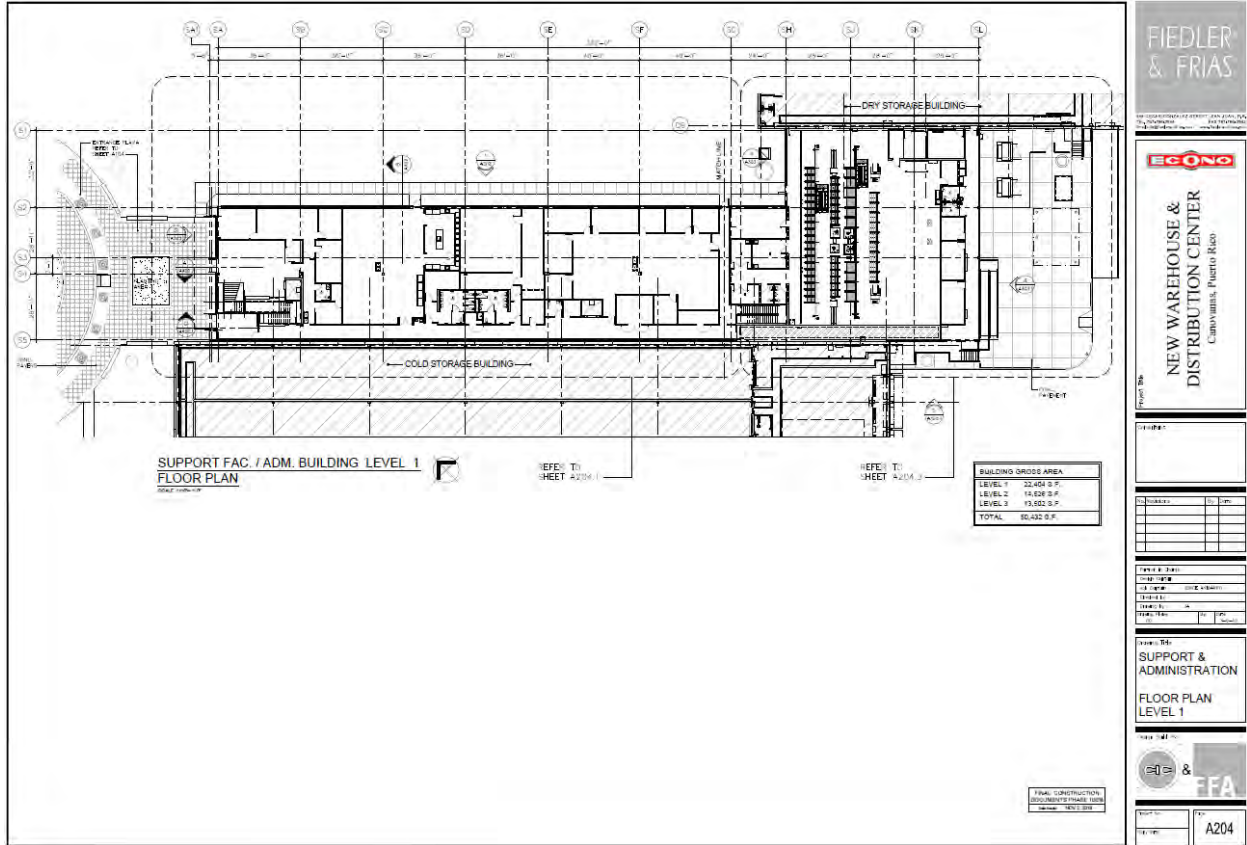

Summary of Construction Details

The following table summarizes the information regarding the subject improvements.

Number of Stories	One at warehouse spaces, while the administrative office area has three levels.
Construction Type	Combination of concrete pre-cast with steel frame components. Exterior walls at cold storage warehouse space include insulated pre-cast concrete panels. Roof has two type of sealing treatment, thermoplastic polyolefin (TPO) and asphaltic treatment.
Height	Dry Warehouse- Gable roof with highest point being at 45' and floor to roof clearing between 38' and 41'. Administrative Offices- 8'-11' floor to ceiling, while floor to roof is 18' at ground level, 12'6" at second and 15'6" at third. Cold Storage Warehouse- Approx. 41' Loading dock at cold storage have a ceiling height of 30'.
Current Use	Distribution Storage Warehouse. Dry storage warehouse components include dry warehouse, some warehouse office space (for warehouse supervisors), employee's restrooms, temperature control space for dog foods and staging/dock areas (one for receiving and one for dispatching). Cold storage warehouse space has cooler staging/docking area, warm cooler temperature storage, cold moist storage space, cold dry storage space, meat freezer area, freezer area and ice cream warehouse space. Office improved spaces at ground level consist primarily of lobby reception, employees entrance reception, employee's lunchroom with food prep area, enclosed office spaces, locker



**PROPOSED ECONO DISTRIBUTION CENTER
SOUTH OF ROAD PR-3, KM 16.2
CANOVANILLAS WARD, CANÓVANAS, PUERTO RICO**

	<p>rooms, restrooms, conference rooms, data room, storage spaces, janitor equipment room and storage areas.</p> <p>Second floor distribution consist of enclosed office area, open office spaces to accommodate office modules, employee's kitchenette, conference rooms, demo kitchen room, training room (three spaces that could be grouped) and other supporting areas.</p> <p>Third floor distribution includes main executives' offices, reception area, board conference room with kitchenette, executive offices, executives restrooms, file room, data room, employee's kitchenette, enclosed office spaces, open office areas to accommodate office modules, security monitor room, server room and technology workshop space.</p>
Interior Walls	<p>Minimum interior walls at warehouse space, mostly for division between amin warehouse spaces and supporting rooms, or for division between cold warehouse components. Interior partitions at cold warehouse spaces are insulated, while interior partitions at other warehouse spaces are mostly made of concrete, plastered and painted.</p> <p>Interior walls at office improved space are mostly made of gypsum board and concrete, plastered and painted. Some interior walls also include glass inserts, while walls at lobby/reception areas may include some wall decorating accent components.</p>
Cold Storage Detail	<p>The cold storage warehouse consists of the box-in-a-box system, which entails what appears to be a secondary insulated structure within the main building.</p> <p>The cold storage warehouse is divided in seven bays/spaces, to allow separation by different type of products and temperatures. Temperature from within each bay 55°, 45°, 36°, 36°, 28°, -10°.</p> <p>There are insulated doors to allow pedestrian access between each bay, plus hi-speed doors between cold warehouses bays and staging/loading dock area.</p> <p>Cooling equipment refers to ammonia includes four cooling towers, evaporators and condensers. The system was reported to be energy efficient, has digital monitoring system and it has a back-up unit.</p> <p>Insulation system includes exterior insulated concrete walls, insulated metal panels, and floor ventilation fan ducts with insulation piping.</p> <p>The loading/staging area has 30 insulated sectional loading doors towards the exterior, with dock shelter, dock bumpers and dock levelers (at dock leveler pit level) with integrated lights.</p>
Ceiling	<p>Dry warehouse space has exposed metal roof, Office improved areas predominantly have acoustic ceiling tiles, gypsum board fascias, and some minor areas with exposed (painted) metal roof. Owner representative indicated that lighting fixtures in the property are approx. 30% LED and the other 70% is fluorescent.</p>
Flooring	<p>Warehouse area has poured, leveled, concrete floor, with a concrete topping system that allows more efficient floor maintenance, less forklift tires friction (reducing tire wear & tear) and overall, more efficient and an overall more efficient warehouse operation.</p> <p>Office improved areas combined mostly carpet and vinyl tile, with some smaller spaces, lobby and common hallways having ceramic tile flooring. Restrooms have ceramic tile flooring and wainscot. Some service/supporting areas have poured, leveled concrete floor.</p>
Restrooms	<p>There are restrooms at every level of administrative office spaces and at dry warehouse space.</p>



**PROPOSED ECONO DISTRIBUTION CENTER
SOUTH OF ROAD PR-3, KM 16.2
CANOVANILLAS WARD, CANÓVANAS, PUERTO RICO**

Doors	Type of doors includes wood doors, frameless glass doors, hollow metal doors, wood-glass doors and glass panels with aluminum or wood frame doors. Yet, most of the interior doors are made of wood, aluminum-glass or wood with glass.
Windows	Combination of glass panels with aluminum frame, while some service areas have жалousies, warehouse spaces have ventilation fans in some areas.
Loading Data	Subject has a total of 72 loading doors, distributed in 30 loading doors at cold storage warehouse and 42 loading doors at dry warehouse. The 42 loading doors at dry warehouse are distributed in 21 doors at opposites of the building, allowing to have areas for merchandise receiving and dispatching. Considering the total existing loading doors, it provides a ratio of 1.78 doors for every 10,000 sq. ft. of building area, which is considered functional for its current operation as a storage/distribution warehouse use. All doors are equipped with exterior loading dock sealer, loading dock bumpers and vertical storing dock levelers.
Amenities	Building amenities include two hydrogen forklift charging stations, fiberoptic communications throughout the property with provider redundancy, warehouse ventilation fans, CCTV security system with 285 cameras and card-controlled access system, server room (with emergency drainage system, VESDA fire suppression system, cooling back-up, temperature sensors and controlled access), capacity/connectivity for solar panels installation, dock height floors and loading ramps.
Access to Building	Administrative offices have exterior access through glass-aluminum doors fronting the main employee's/visitors parking, located between the cold and dry warehouse areas. Main access between three levels of the office space is through two passenger elevators and two staircases. There are also accesses between warehouse and administrative office space. Access to the warehouse spaces is mainly through the loading doors, while there are some additional hollow metal doors for pedestrian/service.

Site and Additional Improvements

Site improvements includes,

- Fence: Made of concrete, chain link, barb wire and iron grilles. It includes the height and gates required to subject comply with being designated a free trade zone area. There are mechanical arms at each access lane of property entrances.
- Concrete guard house at each of the property main entrance. Each guard house is equipped with kitchenette space and restroom. There is a 338 sq. ft. guard house and a 295 sq. ft. guardhouse.
- A 3,000 sq. ft. concrete and metal emergency power generator building.
- Concrete and metal workshop building with 3,000 sq. ft. area. The space also has eye wash station, bathroom, exhaust fans, storage, crane system, compressor room, locker area, grease trap and electric room.
- 940 sq. ft. concrete and metal pump house
- Concrete garbage station
- Property main entrance with concrete pavers, alum. light post, planting area, and concrete benches.
- Aboveground steel 175,000 gallons water tank for fire protect and a 60,000 gallons aboveground steel tank for domestic water use.
- Water well for irrigation system
- Concrete terrace used as trucker's waiting area.



**PROPOSED ECONO DISTRIBUTION CENTER
SOUTH OF ROAD PR-3, KM 16.2
CANOVANILLAS WARD, CANÓVANAS, PUERTO RICO**

- Concrete paved areas in the form of sidewalks, curbs, gutters, islands, ramps and trailers/trucks parking spaces. Subject has truck/trailer parking capacity for 250 trucks, plus land area capacity for expansion. The trailer parking area also includes 82 trailer plugs for cooling capacity.
- 5MVA in-ground power transformer
- Two 2,500 KWA emergency power generator with 600 gallons diesel tank and additional outdoor diesel tank.
- Storm/rain water collection: It includes drainage manhole cover throughout the entire site and the retention pond.
- Asphalt paved areas are mostly found towards the left side and used as employee's/visitor's parking area.
Subject has several two site areas already prepared for future expansion of the warehouse spaces. The sites are already filled, graded and compacted. Rough-in of utilities connection are already located within the expansion site areas.
- Landscaping: grass, some palms, trees and bushes.
- Others: Outdoor illumination, trash/dumpster areas and intercom system.
- Hydrogen plant for forklifts operation. Yet, we were informed that the system and forklifts are on a lease agreement with suppliers.

Utilities & Infrastructure

Electricity- Our report assumes that the property has adequate electricity capacity for its current use.

Water- The property is served with potable water, storm sewer, water reserve system for potable and fire suppression components, and a sanitary system primarily functioning with a septic tank. Similarly, this report assumes adequate capacity/connection of water systems/components for its current use.

Others- The property also provides Wi-Fi connectivity at interior areas, CCTV security system (with about 82 cameras) and fiber optic communications wiring.

Condition and Quality of Construction

Based on the information provided during our inspection, construction of subject improvements started on year 2017 and currently are under the latest stages of the project, specifically in the final punch list. With this in consideration and based on information gathered during our visit to the subject property, subject improvements are considered to be in excellent, as-new condition.



**PROPOSED ECONO DISTRIBUTION CENTER
SOUTH OF ROAD PR-3, KM 16.2
CANOVANILLAS WARD, CANÓVANAS, PUERTO RICO**

CONDITION OF THE IMPROVEMENTS					
	Excellent	Good	Average	Fair	Poor
General Appearance	Extremely attractive and highly desirable X	Quite attractive and desirable	Still somewhat attractive and desirable	Rather unattractive	Undesirable
Building Services	Modern, proper and adequate X	Proper and adequate	Adequate but somewhat dated	Unused, partially removed, or adapted for present occupancy	Antiquated, unused or unusable
Extent of Deterioration	None, perfect or like-new X	Some minor deterioration is visible	Showing signs of normal wear and tear	Deterioration is very noticeable	Structural defects apparent, safety and/or health hazards may exist
Functionality of Improvements	Extremely functional for current use or any other adapted use X	Functional for current use or any other adapted use	Currently functional for its intended use	Only functional for current use with some repairs	Not functional for any use without major repairs
Deferred Maintenance	Full preventive maintenance plan in effect X	Planned maintenance addresses most situations ("Just in Time")	Condition-based or corrective maintenance, in essence, when need arises	Mostly untended	Major signs of deferred maintenance
Replacements & Renovations	Items are regularly replaced or renovated well before reaching the end of their useful lives X	Replacements and renovations are scheduled to be made near the end of an item's useful life	Only "as-need" basis replacements with no major renovations	No signs of renovations and minimum signs of replacements	Outdated and no signs of preventive replacements
OVERALL CONDITION OF THE IMPROVEMENTS:			Excellent		

In terms of quality of construction, there are four basic classifications that could be considered. The next table explains what entails each category and where the subject property falls of these categories.

QUALITY OF CONSTRUCTION CLASSIFICATION	
	LOW QUALITY Buildings in this category are generally constructed to minimum code requirements often with little regard for architectural appearance or other amenities. They are built with minimum investment in mind. Little ornamentation is used and interior partitioning and finish is minimal and/or of low quality.
	AVERAGE QUALITY Average-quality buildings constitute the largest group of buildings constructed, approximately fifty percent of all buildings. These are generally buildings for maximum economic potential without some of the pride of ownership or prestige amenities of higher-quality construction. They are of good standard code construction with simple ornamentation and finishes
X	GOOD QUALITY Buildings designed for good appearance, comfort and convenience, as well as an element of prestige, constitute the Good Quality category. Ornamental treatment is usually of higher quality and interiors are designed for upper-class rentals. The amenities of better lighting and mechanical work are primary items in their costs.
	EXCELLENT QUALITY Excellent buildings are normally prestige buildings. On an economic basis, part of the cost must be written off to price of ownership and some of the income intangible derived from advertising. Excellent dwellings are generally built for the established professional or those with higher income and with some expensive finishes and fixtures.



**PROPOSED ECONO DISTRIBUTION CENTER
SOUTH OF ROAD PR-3, KM 16.2
CANOVANILLAS WARD, CANÓVANAS, PUERTO RICO**

Improvements Analysis: “As-Completed”

The “As-Completed” scenario entails completion of the project, as reported by owner representative. According to owner representative, project is basically in the latest stage with only having to complete a final punch list that represents less than 10% of the entire project.

Work observed to be completed during our inspection included some site work being carried out building main entrance, paved areas being completed around the administrative office space, installation of some electronics/CCTV components and electrical work being carried out around the hydrogen plant.

Project Cost & Estimated Completion

Next table summarize the total project cost as reported by owner representative.

SUMMARY OF PROJECT COST	
Hard Construction Cost	
General Condition & Fees	\$4,226,583
Sitework	\$20,899,622
Cold Warehouse	\$23,610,593
Administrative and Support Building	\$7,885,334
Dry Warehouse	\$11,617,983
Design Cost	\$3,376,552
Total Hard Cost	\$71,616,667
Soft Construction Cost	
Project Management & Consultant Costs	\$3,209,500
Construction Taxes	\$3,500,574
Site & Governm. Improvements	\$2,030,867
Technology & Security Infrastructure	\$3,200,000
Insurance	\$711,137
Permit & Other Expenses	\$111,656
Legal Fees	\$276,900
Design 30%/60%	\$1,784,323
Allowances	\$188,462
B2B (4%)	\$1,124,922
Closing & Other Fees	\$926,552
Unforeseen Contingencies	\$2,325,575
Total Soft Cost	\$19,390,467
Total Project Cost	\$91,007,133
Total Project Cost/GBA; As Completed	\$224.90

The total project cost was reported at \$91,007,133, and it excludes items such as land acquisition, racks, office furniture, capitalized interest cost, and forklifts equipment. Total project cost is equivalent at a rounded \$225/sq.ft. of building area, or \$216/sq. ft. of gross construction area. The reported cost includes all direct and indirect cost, including all site work and permit process.



**PROPOSED ECONO DISTRIBUTION CENTER
SOUTH OF ROAD PR-3, KM 16.2
CANOVANILLAS WARD, CANÓVANAS, PUERTO RICO**

Our research of market data indicates that several market players have invested in conversion of the existing facilities to add some cold storage warehouse spaces, including headquarters of Pueblo Supermarket, Caribbean Produce, Plaza Food System, Selectos Supermarket, and Century Frozen Foods, among others. Out of these market activities, we could obtained the following data.

- **Caribbean Produced Facilities:** Invested about **\$86/sq.ft.** in expansion of cold storage warehouse space and remodeling the office space. According to information obtained, the remodel work included acquisition of second hand (used) insulated wall panels and cooling equipment.
- **Pueblo Supermarket:** They are investing about **\$140/sq.ft.** in conversion of 9,594 sq. ft. dry warehouse space into cold (cooler/freezer) storage warehouse area. This project started on year 2020.
- **Selectos Supermarket:** On May 2021 the company announced a \$10million investment on expansion of their facilities to add 125,000 sq. ft., 22 loading doors. This is equivalent to **\$80/sq.ft.**, and information gathered does not indicates if includes any cold storage warehouse area.
- **Plaza Food System:** The company just started a remodel and expansion of their facilities to add cold storage warehouse space, convert existing cold warehouse into dry warehouse area and remodel office space. The project was reported to have a total cost of **\$150/sq.ft.** of total proposed gross building area, with **\$175/sq.ft.** for the direct construction cost of the cold storage warehouse (cooler/freezer). The \$175/sq.ft. figure does not include indirect construction cost or site work.

The information above states a project costs ranging from \$80/sq. ft. to \$175/sq.ft. However, they refer to remodel/expansion of existing facilities and not a fully new development, like subject's. Furthermore, subject lot is considerably bigger than the lots of the projects listed above because owner of the subject property visions an expansion of the facilities in the future. This expansion vision entails that the site was prepared for such future expansion, leaving two site areas already prepared for such expansion. Based on the proposed project, it is considered that subject property will enjoy better market appeal upon completion of the proposed improvements because it will attract to several type of users of industrial facilities with dry and cold storage space.

In terms of cost to complete the proposed project, we were informed that project is currently in the final stage of project, identified as project's final punch list. Next is an image of the amount reported to be needed to complete the project.

CONTINUATION SHEET

AIA DOCUMENT G703

PAGE 22 OF 22 PAGES

AIA Document G702, APPLICATION AND CERTIFICATE FOR PAYMENT, containing Contractor's signed Certification, is attached.
In tabulations below, amounts are stated to the nearest dollar.
Use Column I on Contracts where variable retainage for line items may apply.

INVOICE NO: 10271
PERIOD TO: 04/30/2021
PROJECT NO: 2017-011
APPLICATION NO: 00038

A ITEM NO.	B DESCRIPTION OF WORK	C SCHEDULED VALUE	D WORK COMPLETED		F MATERIALS PRESENTLY STORED (NOT IN D OR E)	G TOTAL COMPLETED AND STORED TO DATE (D+E+F)	H % (G-C)	I BALANCE TO FINISH (C - G)	J RETAINAGE (IF VARIABLE) RATE
			FROM PREVIOUS APPLICATION (D + E)	THIS PERIOD					
C000229	Cambios en Diseño Civil Acceso PR03 - Allow	\$100,989.90	\$0.00	\$98,970.10	\$0.00	\$98,970.10	98.000	\$2,019.80	\$0.00
C000234	Rock Excavation - Swales	\$5,330.00	\$0.00	\$5,223.40	\$0.00	\$5,223.40	98.000	\$106.60	\$0.00
		\$69,414,344.35	\$68,288,488.60	\$404,806.00	\$0.00	\$68,693,294.60	98.96%	\$721,049.75	\$0.00

According to information furnished, the amount left to completer subject project is \$721,049.75. information gathered during our inspection reveals that work remaining to be completed include some site infrastructure, completion of some concrete paved areas, finish the new intersection at Road PR-3, complete some electrical work next to hydrogen plant, and



**PROPOSED ECONO DISTRIBUTION CENTER
SOUTH OF ROAD PR-3, KM 16.2
CANOVANILLAS WARD, CANÓVANAS, PUERTO RICO**

completion of site work around employee's parking area. Based on the information provided, completion date of subject project is expected to be August 1, 2021.

Occupancy Ratio Analysis

Subject's building to land ratio is at 11% with the existing facilities. However, as stated previously, subject was developed planning for a future expansion of cold & dry warehouse spaces, while because subject does not have access to public sewer system, subject project also includes a retention pond area and an area for water waste treatment plant. Based on the information above, subject occupancy ratio is considered reasonable.

Zoning

Based on the prevailing zoning map extracted from the Puerto Rico Planning Board webpage, the subject property falls under an "I" industrial zoning. Next are images of the information found in the Puerto Rico Planning Board webpage.

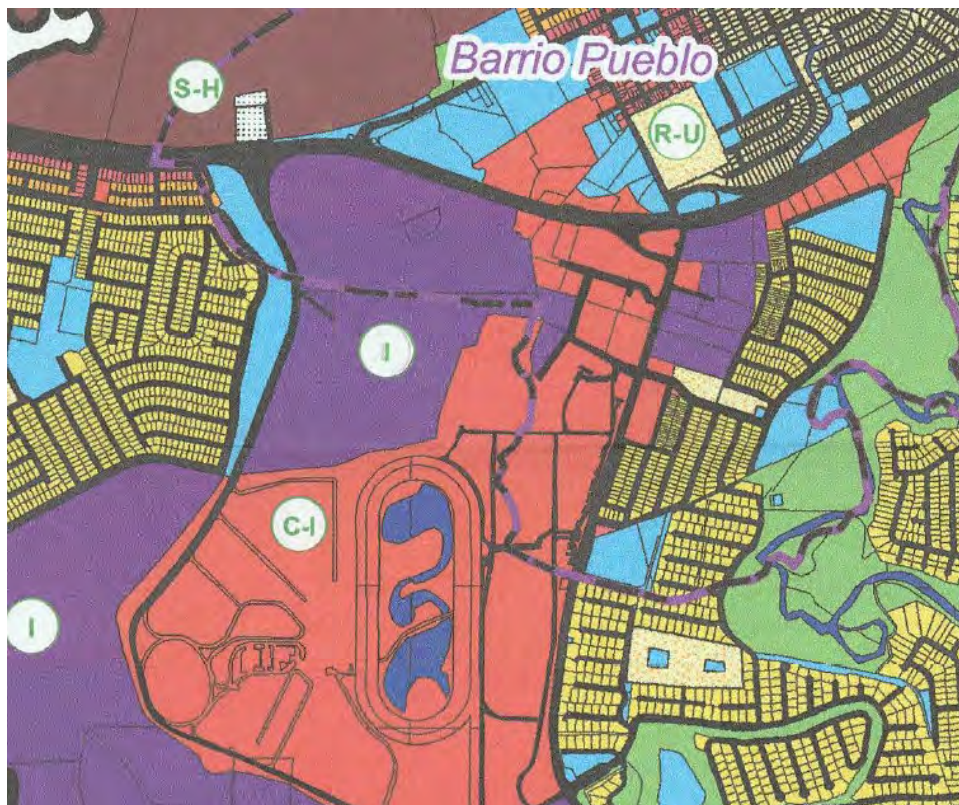

**PROPOSED ECONO DISTRIBUTION CENTER
SOUTH OF ROAD PR-3, KM 16.2
CANOVANILLAS WARD, CANÓVANAS, PUERTO RICO**



According to the information gathered from the Puerto Rico Planning Board, the subject property falls under an "I" zoning, which is defined as Industrial zoning. However, the "I" zoning was not found in any of the Joint Regulations issued by the Puerto Rico Planning Board. Thus, no analysis could be given to the parameters/regulations of this zoning. Still, we were able to confirm with the Puerto Rico Planning Board webpage that subject project recently developed obtained development approvals for its completion.



PROPOSED ECONO DISTRIBUTION CENTER
SOUTH OF ROAD PR-3, KM 16.2
CANOVANILLAS WARD, CANÓVANAS, PUERTO RICO

SBP Single Business Portal

-Nombre: INC SUPERMERCADOS ECONO

Arrendatario:

-Nombre:

Tipo de Trámite:

-Tipo de Permiso: PCOC-Permiso de Construcción Consolidado

Legenda:

- Incompleto
- Pago o Pendiente a Iniciar
- Inspección o Secretaría
- Rectificación (Subsanación)
- En espera de Requerimientos o Agencias
- Gerente
- Revisión Legal
- Archivado
- Denegado o Cerrado
- Aprobado

Based on the above indications, subject existing improvements are assumed to comply with zoning parameters and are assumed to have a valid use permit.



**PROPOSED ECONO DISTRIBUTION CENTER
SOUTH OF ROAD PR-3, KM 16.2
CANOVANILLAS WARD, CANÓVANAS, PUERTO RICO**

PROPERTY TAX DATA AND ASSESSED VALUATION

The current property tax rate for the municipality of Canóvanas is 10.33%. For the purpose of property tax determination, all properties on the Island have their assessed values based on the assessed value of similar properties as established in the years 1957-58. Consequently, the values established by the Government for taxation have no correlation to market value.

The laws in Puerto Rico assigned all property tax responsibilities to the individual municipalities. However, property tax collection is centralized at the Municipal Income Collection Center (CRIM by its Spanish acronym). Property taxes are imposed on each property on the first day of the year. However, these taxes are not due for payment until the fiscal year running from July to June of the following year.

Since fiscal year 1974, property taxes are invoiced and paid on a semi-annual basis. A 10% discount is automatically granted for prompt payment within 30 days after the issuance of the tax invoice. Next are images of the property tax data furnished by the owner of the property.



**PROPOSED ECONO DISTRIBUTION CENTER
SOUTH OF ROAD PR-3, KM 16.2
CANOVANILLAS WARD, CANÓVANAS, PUERTO RICO**



Estado Libre Asociado de Puerto Rico
CENTRO DE RECAUDACIÓN DE INGRESOS MUNICIPALES

**CERTIFICACIÓN DE VALOR
Value Certificate**

Núm. de Certificación:

WX2021051213346

REGULAR

1. Información de la propiedad / Property Information				
Número de Catastro / Parcel Number				Localización de la Propiedad / Property Location
117-000	003	01	000	BO CANOVANILLAS CARR 3 KM 16.2 LOTE 3
Mapa	Manzana	Parcela	Edificio	CANOVANAS
2. Esta propiedad está valorada de la siguiente manera / The valuation of this property is as follows:				
1)	Terreno / Land			215,498.00
2)	Estructura / Structure			0.00
3)	Maquinaria / Machinery			0.00
4)	Valor Total / Total Assessed			215,498.00
3. Esta propiedad tiene una cabida de:				311,334.60 m2
This property has a capacity of:				
4. A esta propiedad y/o su dueño se le concedió una exención contributiva de:				0.00
Efectiva desde:				
This property and/or its owner was granted a tax exemption for:				
Effective as of:				
5. A esta propiedad y/o su dueño se le concedió una exoneración contributiva de:				0.00
Efectiva desde:				
This property and/or its owner was granted a tax exoneration for:				
Effective as of:				
6. Nombre del Dueño / This property is under the name of:				
SUPERMERCADOS ECONO INC				
Fecha Emitida / Issued Date:		Fecha Expiración / Expiration Date:		
10-May-2021		10-Aug-2021		
				Certificación Electrónica
<p>Nota aclaratoria: La información suministrada en esta certificación puede ser afectada por cualquier investigación o intervención de cuenta que se haya iniciado o esté por iniciarse a este contribuyente. Esta certificación tendrá vigencia de 3 meses a partir de la fecha de emisión.</p> <p>Note: The information submitted in this certificate can be affected by any investigation or intervention to the account. This certification will be valid for 3 months from the issue date.</p>				

WX2021051213346

1213346

10/05/2021 4:10 PM

Validar certificado en <http://crimpr.net/certificados>

Page 1 of 1



**PROPOSED ECONO DISTRIBUTION CENTER
SOUTH OF ROAD PR-3, KM 16.2
CANOVANILLAS WARD, CANÓVANAS, PUERTO RICO**



According to the information above, subject has an assessment value only for the land component. Thus, careful consideration must be given to an assessment update in the near future.

We assume that the documents provided are from correct and that belong to the subject property. We also assume no responsibility for items relating to property tax or its accuracy and/or past due taxes or assessments. In addition, we assume that there is no property tax outstanding balance.



**PROPOSED ECONO DISTRIBUTION CENTER
SOUTH OF ROAD PR-3, KM 16.2
CANOVANILLAS WARD, CANÓVANAS, PUERTO RICO**

NEIGHBORHOOD ANALYSIS

The subject property is located North of the PR-66 Expressway within Pueblo Ward of Canóvanas, Puerto Rico. The subject property is close to municipality boundary between Canóvanas and Loiza/Rio Grande. Canóvanas is surrounded by the municipalities of Carolina, Loiza, Rio Grande, Juncos, and Las Piedras. The subject neighborhood is delineated by Expressway PR-66 to the south, territorial division between Canóvanas and Loiza / the Loiza River to the west, territorial division between Road PR-187 to the east and the Atlantic Ocean to the north. The general neighborhood is delineated in the following map.

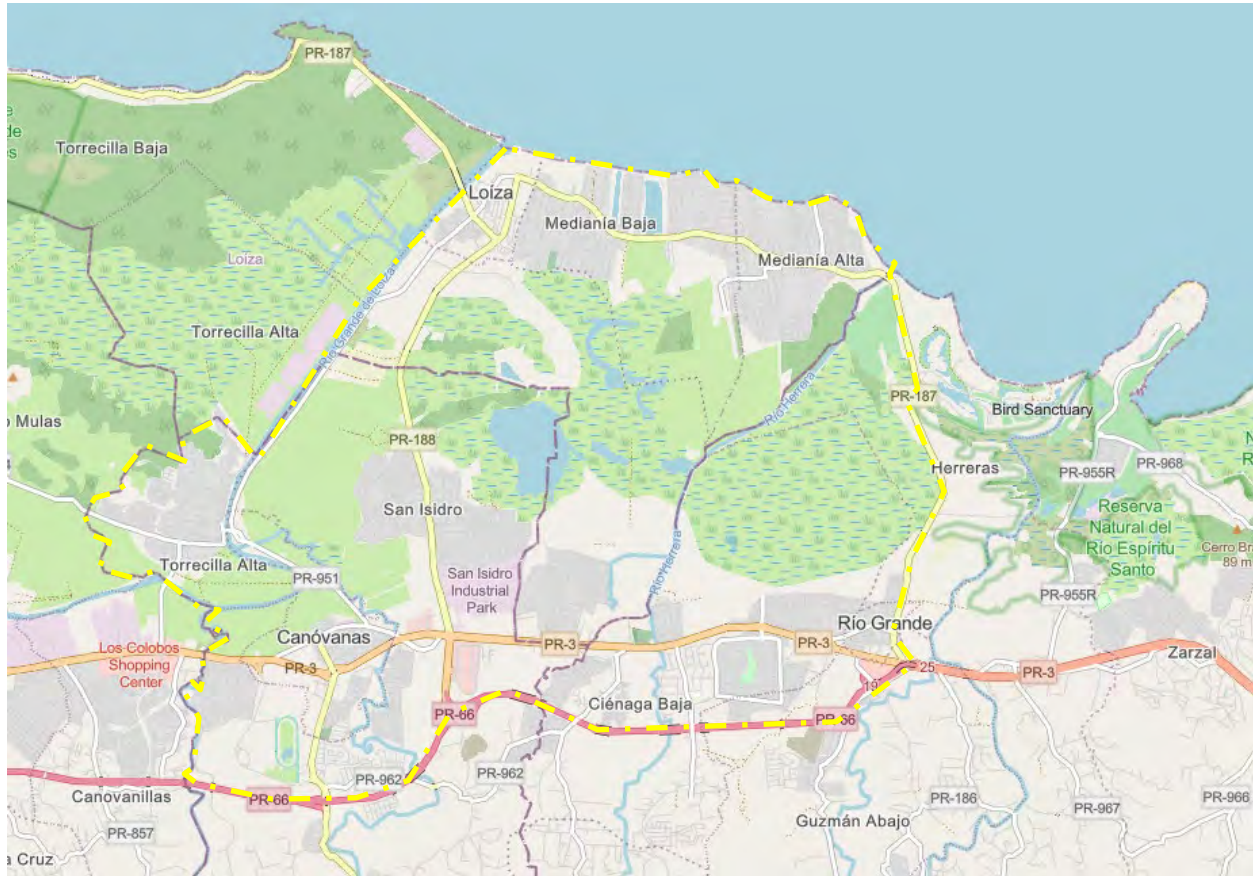

The immediate neighborhood is recognized as one of the most transited commercial districts of the Eastern Area of the island. Subject's frontage to Road PR-3 places it at a close distance to other main roadways of the area like Roads PR-188 and PR-187. Subject is also less than 5 miles away from Expressway PR-26, which is the main roadway that connects Carolina to the San Juan Metropolitan Area and thus, subject has adequate linkages.

As a result of the linkages previously mentioned, the subject general neighborhood has been an attractive area for commercial-retail properties, supported by proportional office developments. Subject's immediate neighborhood mostly consists of commercial-retail properties with some residential developments in interior streets. The commercial sector is mostly located along both sides of Road PR-3. Places of interest in the neighborhood includes, many industrial properties, shopping centers, hospitals, public and private schools, houses of worship, professional offices, recreational places, restaurants, hospitals, governmental offices and fuel stations.



**PROPOSED ECONO DISTRIBUTION CENTER
SOUTH OF ROAD PR-3, KM 16.2
CANOVANILLAS WARD, CANÓVANAS, PUERTO RICO**

The subject neighborhood analysis comprises mostly of the traditional urban area of Canóvanas. Some of the most recognized brand names close to subject are; San Isidro Industrial Park, Econo Distribution Center, Plaza Canóvanas, Hipodromo Camarero, Marshalls, Rio Grande Towne Center and many other.

The previously mentioned routes of access, and the composition of its neighborhood, place the subject's immediate area in prime geographic position. The subject enjoys relatively fast communication to and from the major places of interest of the area. In addition, there is daily postal delivery, garbage collection, street cleaning, and fire and police protection. The area also has water, electricity, and telecommunications.

The subject neighborhood also enjoys a heavier traffic during weekdays as a result of the traffic generated by several recognized commercial businesses. The neighborhood surrounding the subject is mainly residential /commercial in nature, with the predominant uses being retail properties.

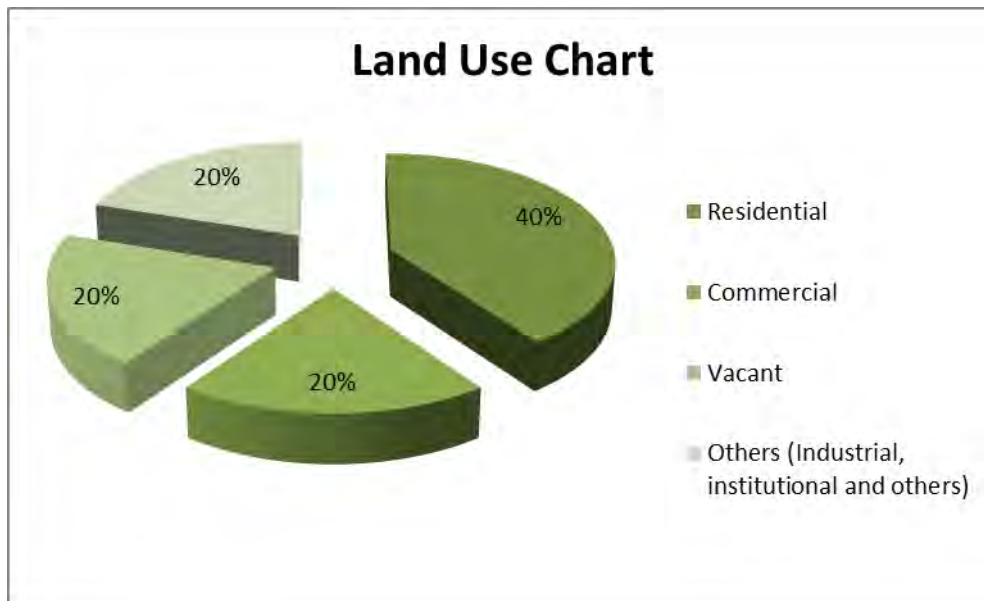

Taking into consideration all elements that affect uses of properties, no potential change in the current uses of properties is visualize in the near future. Streets have adequate illumination in some areas. In terms of overall market conditions, the following summarizes the most salient facts of the delineated neighborhood.

- Supply and Demand: Slightly oversupplied
- Real Estate Cycle: Towards the end of the recession cycle reaching a stabilization
- Value Trend: Stable
- Typical Marketing Time: 12 to 24 months

Market conditions in the subject neighborhood are similar to the ones affecting the entire island. These economic conditions are not expected to improve in the near future. Quite the contrary, the government fiscal difficulties are expected to worsen in the following years and this is expected to have its effect in the overall economic conditions of the island, including the real estate market. In summary, its good location within this neighborhood served by adequate routes of access provides the subject property with all the facilities needed to continue operating successfully, with potential room for future growth as its transportation linkages continue to improve.



HIGHEST AND BEST USE

Highest and Best Use is defined, in The Dictionary of Real Estate Appraisal, Sixth Edition, published by the Appraisal Institute, as follows:

“The reasonably probable use of property that results in the highest value. The four criteria that the highest and best use must meet are legal permissibility, physical possibility, financial feasibility, and maximum productivity.”

Highest and best use studies market forces and how they affect the property. Finding the highest and best use is very important in the appraisal process, because the use selected for the subject property will be the basis for selecting the comparable transactions chosen for the research.

In the case at hand, subject property consists of a 311,346 sq. mt. site improved with an industrial facility. Therefore, we developed two highest and best use analyses for subject property. One is assuming the subject site as though vacant, and the second analysis is the subject property with the existing improvements.

Highest and Best Use of Site As Though Vacant

Legally Permissible

Subject falls under an industrial, which when combined with composition of properties fronting Road PR-3, it is considered that subject allowed uses include commercial, industrial and institutional uses.

Physically Possible

Even though the subject site has an irregular shape, it is functional for the legally permissible uses. In the case of infrastructure for residential and commercial uses, it is considered that subject lack of access to public sewer system and that the connection to the sewer system is at a considerable distance affects the feasibility of such uses. Therefore, residential and commercial use are discarded from further analysis.

Taking into consideration all the previous indications and analysis, the legally permissible and physically possible uses are institutional and industrial.

Financially Feasible and Maximally Productive

The analysis carried out left redounds in subject potential institutional and/or industrial use. However, institutional uses are commonly developed without profit expectancy and as result, this use is discarded from further analysis.

After discarding all other uses and taking into consideration the subject location and neighborhood composition, we consider that the financially feasible and maximally productive use is industrial, but not at this point in time. Therefore, we are of the opinion that the highest and best use, as if vacant, of the subject site will be holding for future industrial development.

Timing of the Use	2 to 3 years
Interim Use	Remain dormant
Most likely buyer	A speculative investor
Most likely user	Local real estate developer



**PROPOSED ECONO DISTRIBUTION CENTER
SOUTH OF ROAD PR-3, KM 16.2
CANOVANILLAS WARD, CANÓVANAS, PUERTO RICO**

The Ideal Improvements

The ideal improvements consist of a one-story warehouse facility which includes 20' to 35' ceilings, good site positioning to allow adequate space for truck maneuvering, dock height floors, 1 loading dock per 10,000 sq. ft. of warehouse area, loading docks with dock/pit levelers to accommodate different type of trucks, wet sprinkler system, spread columns to increase bay size and 10 to 15 percent of supporting office space either in ground floor or as a mezzanine space. Other complementary elements that could be included are some efficiency features like lighting movement sensors, industrial fans for ventilation, high speed automatic roll-up doors for climate-controlled areas and air conditioning with inverter system.

The subject property refers to a recently built industrial property with adequate ceiling height, good amount of loading doors, adequate office space and an overall good distribution between cold warehouse, dry warehouse and office space. The property also enjoys modern/efficient components that are considered appealing for most potential users of this type of facilities.

Thus, it is considered that subject is do not suffers from any functional obsolescence. Yet, the subject property suffers from external obsolescence as a result of current economic condition as this type of properties are commonly sold for less than their replacement cost.

Highest and Best Use as Improved

Legally Permissible Uses

After investigation and analysis of the subject neighborhood, along with its zoning classification and documents submitted, it is considered that the subject current use conforms to its current zoning district. For purpose of this report, and since no evidence to the contrary was submitted, construction permit and use permit are assumed for the existing and proposed improvements.

Physically Possible Uses

The improvements on the subject property are in excellent, as-new, condition, and suitable for industrial use, thus meeting the physically possible criteria.

Financially Feasible & Maximally Productive

In this appraisal we concluded with a prospective market value opinion ("As-Completed") for the subject property of \$82,600,000.00. The land is an irregular, but functional, site for retail use. This conclusion implies that the subject's improvements will contribute as long as the unitary value for the site as though vacant is less than \$1,040,000 per cuerda ($\$82,600,000 \div 79.22 \text{ cuerdas} = \$1,042,729 \text{ per cuerda}$, rounded to \$1,040 per cuerda).

Unitary prices for similarvacant sites (or properties acquired for demolition) with similar land area and development potential in the subject market area range from \$14,000 to \$80,000 per cuerda.

Conclusion

Based on this, we are of the opinion that the highest and best use of the subject property is to continue operations as a retail property.

Timing of the Use	Current
Interim Use	Not applicable
Most likely buyer	Distribution Businesses/Manufacture



PROPOSED ECONO DISTRIBUTION CENTER
SOUTH OF ROAD PR-3, KM 16.2
CANOVANILLAS WARD, CANÓVANAS, PUERTO RICO

Most likely Use Owner-User

Highest and Best Use; "As-Completed" Scenario

As stated throughout the report, the proposed project entails completion of the minor details left of the subject industrial facility. The information furnished indicates that the amount needed to complete the project is about \$720,000, and it refers to the latest final punch list of the project.

Taking into consideration that it refers to a minor portion of the project, but that is considered useful/functional for operation of subject warehouse, it is considered that completion of the proposed project as described herein is the highest and best use of the subject property.



APPRAISAL PROCESS

There are three basic approaches that may be used by appraisers in the estimation of market value. These three approaches provide data from the market from three different areas when all are available. These three approaches are the Sales Comparison Approach, the Income Approach and the Cost Approach.

The Cost Approach has as its premise, the valuation of the site by comparison with other sites in the area that have sold in the recent past, making adjustments for differences to indicate a site value estimate. To this site value is added the estimated cost to reproduce or replace the improvements, less any loss of value (depreciation) that might have transpired or taken place.

The Sales Comparison Approach has as its premise a comparison of the subject property with others of a similar design, utility, and use that have sold in the recent past. To indicate a value for the property, adjustments are made to the comparable sales for differences with the subject.

The Income Capitalization Approach as used for income-producing properties has as its premise the estimation of the net operating income of the subject property for the year following the appraisal date. This net operating income is then capitalized by a market derived overall capitalization rate into an indication of market value.

The approach can also be developed using a discounted cash flow model in which the net operating income for each year of the holding period is forecasted. This net operating income is then brought to present value by a discounting process. Finally, the present value of the reversion at the end of the period is added to arrive at a value indication by discounted cash flow analysis.

Normally, these three approaches will each indicate a different value but should fall within a reasonable range. After the strengths and weaknesses of each of the approaches are considered, the three indicators of value are reconciled into a final value estimate.

The following pages of this report contain the development of the applicable approaches to value. The applicability of each of the approaches to the appraisal problem will be explained in the appropriate section of the report.



INCOME CAPITALIZATION APPROACH; "AS-COMPLETED"

There are two income capitalization methods that can be used to estimate the market value of the subject property. Both methods are based on different measures of expected earnings and include different conclusions concerning the relationship between expected earnings and value.

The first method is direct capitalization, which is defined in The Dictionary of Real Estate Appraisal, 6th Edition, published by the Appraisal Institute as follows:

"Direct capitalization is a method used to convert an estimate of a single year's income expectancy into an indication of value in one direct step - either by dividing the income estimate by an appropriate income rate or by multiplying the income estimate by an appropriate factor."

The second method, yield capitalization, is defined in the same dictionary as follows:

"Yield capitalization is a method used to convert future benefits into present value by discounting each future benefit at an appropriate yield rate or by developing an overall rate that explicitly reflects the investment's income pattern, value change, and yield rate."

Valuation Methodology

In order to develop the income approach, we must find recent rentals that could be considered similar/comparable to the subject property. Yet, in the case at hand, subject refers to a just finished industrial facility, and our research does not reveal any truly comparable rental in terms of size, amenities, quality of construction and condition, among other value driven characteristics. Therefore, the income approach was not developed.



COST APPROACH; “AS-COMPLETED”

Introduction

The cost approach to value is based on comparison, since the cost to develop a property is compared with the value of the existing property or a similarly developed property. In this approach, we estimate the value of the site and the cost to construct a reproduction (exact replica) of, or replacement (having similar utility with current materials and design) for, the existing structure and site improvements (including direct costs, indirect costs, and an appropriate entrepreneurial profit when applicable), and then deducts all accrued depreciation in the property as of the date of valuation from the total reproduction or replacement cost. When the value of the site is added to this figure, the result is an indication of value of the fee simple interest in the property.

The Cost Approach is usually very reliable in the case of new properties, not affected by depreciation, and when appraising special purpose properties, where there is insufficient market data to develop other approaches. In the case of recently developed properties, the Cost Approach can provide strong supporting evidence for the Market Value in Fee Simple.

Subject Valuation

The subject property refers to An almost completed industrial property/distribution warehouse in which the scope of this assignment includes two scenarios, valuation of the “As-Is” that refers to the industrial facility with minor details left to be completed, and valuation of the subject property under the “As-Completed” scenario that entails the completion of the proposed industrial project.

Taking into consideration as-new condition, the overall physical attributes of the subject proposed project, and the trends in the industrial market, specifically in newer properties with better quality, our analysis do not consider any kind of physical, functional or external depreciation.

Site Valuation

Land value must always be considered in terms of its highest and best use, since this influence the selection of comparable transactions. Even when the land has improvements, its value estimate must be based on its highest and best use as though vacant. The reason is that the property could conceivably be made vacant by demolishing the existing improvements, in order to develop it to its highest and best use.

There are four procedures available to value vacant land. These are; sales comparison, allocation, extraction, and income capitalization, which is divided into direct capitalization techniques (land residual and ground rent capitalization) and yield capitalization techniques (subdivision development analysis). As mentioned earlier in the Scope of the Assignment section of the report, the sales comparison procedure was determined to be the most appropriate method to value the site.

The Sales Comparison Approach is the process in which a value estimate is obtained by analyzing and adjusting sales of properties similar to the subject’s site. The comparative analysis in this approach focuses on differences in property rights transferred vs. appraised, financing terms, conditions of sale, and market conditions at the time of sale, location, and physical characteristics. Sales of vacant lots were listed, analyze and adjusted to arrive at an indication of value for the subject parcel. The following pages contain information about the comparable sales.



**PROPOSED ECONO DISTRIBUTION CENTER
SOUTH OF ROAD PR-3, KM 16.2
CANOVANILLAS WARD, CANÓVANAS, PUERTO RICO**



Sale 1



Sale 2



**PROPOSED ECONO DISTRIBUTION CENTER
SOUTH OF ROAD PR-3, KM 16.2
CANOVANILLAS WARD, CANÓVANAS, PUERTO RICO**



Sale 3



Sale 4



**PROPOSED ECONO DISTRIBUTION CENTER
SOUTH OF ROAD PR-3, KM 16.2
CANOVANILLAS WARD, CANÓVANAS, PUERTO RICO**

SUMMARY OF COMPARABLE LAND TRANSACTIONS					
Transaction	Subject	1	2	3	4
Location	South of Road PR-3, Km 16.2, Canovanillas Ward, Canóvanas	North of Road PR-685, Km 5.5, Tierras Nuevas Saliente Ward, Manatí	Emilio Fagot Avenue, Machuelo Arriba Ward, Ponce	Road PR-110, Km 25.4, Arenales Ward, Aguadilla	Road PR-694, Km 2.2, Higuillar Ward, Dorado
Geographic Coordinates	18.3729,-65.9065	18.4674,-66.4850	18.0348,-66.596	18.4708,-67.1012	18.3332,-67.2127
Seller		Ricardo Vega Soler	GDB Debt Recovery Auth.	Banco Popular de PR	Comp. Fomento Industrial de PR
Buyer		Central Waste Service, Inc.	Saint Lukes Memorial Hospital	Hector M. Lorenzo Lorenzo	Integrated Commercial Developers
Date of Sale	NA	February-19	March-19	October-19	December-20
Transaction Price	NA	\$260,000	\$3,000,000	\$575,000	\$1,440,000
Area of Parcel in Cuerdas	79.22	18.02	87.34	25.74	18.43
Unit Price (S.P. per cuerda)	NA	\$14,428	\$34,349	\$22,343	\$78,136
Zoning	I	R-I	EV.4	I-L	APE-ZC
Topography	Varies with level, rolling downwad and hilly	Mostly level with gently rolling downward	Mostly level with rolling downward and some hilly areas	Level with gently rolling, hilly and some sloping downward	Some level with hilly and downwad slope areas
Configuration	Irregular	Irregular	Irregular	Irregular	Irregular
Flood Zone Classification	Zone X	Zone X	Zone X	Zone X	Zone X
Highest & Best Use	I- Industrial	Residential	Commercial	Commercial-Residential	Commercial
Verification Source	Inspection	Registry/Broker	Broker/Field Inspection	Buyer/Broker	Seller
Deed # & Lawyer		41, Adamitza Matute	3, Luis Caceres	330, Hector Lugaro	10, Celeste A. Rexach
Comments		Acquired for potential development/investment in the upcoming years.	Acquired for commercial development. Buyer owns medical facility next to acquired lot.	Acquired for gas station development in a portion fronting Road PR-110, while rear will be hold for residential-commercial development in the future.	Bought for commercial development.
Tax ID	098-008-363-03	016-000-007-57	365-000-008-69	006-000-007-17	059-000-002-02

Adjustment Analysis, Reconciliation and Conclusion

The transactions listed above represent the most recent and similar comparable transactions found. Taking into consideration market data gathered along with the analysis carried out, we will use sale price divided by land area (in cuerda) as the unitary indication for the analysis being carried out herein. The listed transactions provide \$/cuerda indications ranging from \$14,428 to \$78,136 per square meter.

The upper end is established by Sale 4, which is considerably smaller and enjoys superior location and accessibility. On the other hand, Sale 1 established the lower end, but it is considered inferior in location, access and zoning. The next table summarizes the analysis carried out of the listed sales, including a value positioning of the subject property.

LAND SALES RECONCILIATION					
Sale No.	Location	Land Area (Cuerda)	\$/Cuerda Indication	Overall Comparability	
4	Dorado	18.43	\$78,136.00	Superior -Smaller than subject, better location as it enjoys proximity and partial exposure to Expressway PR-22	
2	Ponce	87.34	\$34,349.00	Superior -Superior topography, frontage to more than two roadways and acquired by owner of adjacent property.	
3	Aguadilla	25.74	\$22,343.00	Superior -Smaller than subject ***SUBJECT POSITIONING***	
1	Manatí	18.02	\$14,428.00	Inferior -Although smaller, it is considered inferior in topography, zoning and location.	

Analysis of the listed sales indicates that subject \$/cuerda indication should be higher than \$14,428 and lower than \$22,343, which are the indications of Sales 1 and 3. According to information provided, subject was acquired for \$1,650,000 on July 2017, equivalent to \$20,828 per cuerda, an indication that falls well within the range established by Sales 1 and 3.

**PROPOSED ECONO DISTRIBUTION CENTER
SOUTH OF ROAD PR-3, KM 16.2
CANOVANILLAS WARD, CANÓVANAS, PUERTO RICO**

Value Conclusion

Based on the previous indications and analysis, we concluded with a rounded value indication for the fee simple interest in the site, assumed vacant and available for redevelopment, of **\$1,650,000**.

Improvements Valuation

Replacement Cost New; "As-Completed" Scenario

After the value of the site, assumed vacant and available for use has been estimated, the next step in the cost approach to obtain an "As-Completed" indication is the estimation of the Replacement Cost New (RCN) of the improvements. For this section of the appraisal report, taking into consideration the information available, we used project cost data provided by the owner of the property combined with information obtained from the Marshall and Swift Valuation Service and information obtained from local contractors.

The analysis to be carried out consists in carrying out a cost estimate with Marshall Valuation data combined, information from local contractors and market data found of construction cost of cold storage warehouses. The conclusion obtained from this analysis will be compared and reconciled with the project cost data provided by owner of the property.

Replacement Cost New- Marshall & Valuation Analysis

Given the characteristics of the proposed improvements, we relied on Marshall cost information about Neighborhood Shopping Center Shell Buildings in the commercial section of index.

The Marshall Cost factors include architect's fees, contractor's overhead and profit, financing costs (interest on construction loan). However, they do not include costs of buying or assembling land, feasibility studies, environmental studies, appraisals, discounts or bonuses paid for financing, fixture and equipment, developmental overhead, yard improvements, off-site costs and furnishings. Based on subject project size, these costs are labeled miscellaneous costs and were estimated at 10% of Marshall Cost factors.

Similar to the cost estimate procedure for the improvements, we determined the replacement cost new of the additional site improvements. For these items we relied on Sections 14, 44, 53, 54, 61 and 66 of the Marshall and Swift Valuation Service and information from local sources. In the following tables we have included base cost indicators for the different buildings and or structures that composed the subject property.



**PROPOSED ECONO DISTRIBUTION CENTER
SOUTH OF ROAD PR-3, KM 16.2
CANOVANILLAS WARD, CANÓVANAS, PUERTO RICO**

Marshall's Replacement Cost New - Building

Survey Method	Calculator Cost	Calculator Cost
1 Occupancy	Distribution Warehouse	Cold Storage Warehouse
2 Location	Canovanillas, Puerto Rico	Canovanillas, Puerto Rico
3 Building Class/Quality Type	C / Good	C / Good
4 Exterior Wall	Metal, RC-CB	Metal, RC-CB
5 No. of Stories/Average Height per Story	3 / 40	1 / 40
6 Average Construction Area (square feet)	265,048	139,612
7 Average Perimeter (linear feet)	N/A	N/A
8 Chronological Age and Condition	Less tha 1 Yr.; As-New	Less tha 1 Yr.; As-New
9 Region	Eastern	Eastern
10 Climate	Extreme	Extreme
11 Base Square Foot Cost	\$77.50	\$99.00
12 Heating/Cooling Adjustment	\$0.00	\$0.00
13 HVAC Adjustment	\$0.00	\$0.00
14 Other - Sprinklers+Dock Height+Elevator	\$6.75	\$3.93
15 Total lines 11 through 14	\$84.25	\$102.93
16 Number of stories-multiplier	1.000	1.000
17 Height per story multiplier (see Line 5)	1.650	1.650
18 Floor area-perimeter multiplier, lines 6 & 7	1.000	1.000
19 Combined Multiplier (multiply lines 16,17, 18)	1.650	1.650
20 Refined Sq Ft Cost (Line 15 x Line 19)	\$139.01	\$169.83
21 Current Cost Multiplier (Sect. 99, p. 3)	1.09	1.09
22 Local Multiplier (Sect. 99 p. 5 thru 10)	0.88	0.88
23 Final Sq. Ft. Cost (Line 20 x Line 21 x Line 22)	\$133.34	\$162.91
24 Construction Area (square feet)	265,048	139,612
25 Building Replacement Cost (Line 23 x Line 24)	\$35,341,714	\$22,743,528
26 Plus: Additional Site Improvements (Lump Sum)	\$8,000,000	\$0
27 Replacement Cost (Line 25 + Line 26)	\$43,341,714	\$22,743,528
28 Additional Indirect Costs (5%)	\$2,167,086	\$1,137,176
29 Total Replacement Cost (Line 27 + Line 28)	\$45,508,799	\$23,880,705
30 Rounded to	\$45,500,000	\$23,900,000

Source: Section 14 Dated February 2020

The following table accounts for the RCN calculation for site and additional improvements.

Additional Improvements			
Power Generator Building	3,000	sq.ft. x \$65.00 =	\$195,000.00
Workshop Building	3,000	sq.ft. x \$65.00 =	\$195,000.00
Ice Cream Truck Loading Area	8,735	sq.ft. x \$40.00 =	\$349,400.00
Guard House	338	sq.ft. x \$100.00 =	\$33,800.00
Guard House	295	sq.ft. x \$100.00 =	\$29,500.00
Pump House	940	sq.ft. x \$65.00 =	\$61,100.00
Water Reserve System; Tanks-175,000 glls.+ 60,000 glls.			\$684,450
Transformer, Generators & Diesel Tanks			\$4,270,000
Paved Areas, Landscaping, Fence			\$1,753,500
Others (CCTV, Terrace, Retention Pond, Water Well & Others)			\$395,000
Total RCN			\$7,966,750
Rounded to:			\$8,000,000



**PROPOSED ECONO DISTRIBUTION CENTER
SOUTH OF ROAD PR-3, KM 16.2
CANOVANILLAS WARD, CANÓVANAS, PUERTO RICO**

Based on the Marshall and Swift cost estimate carried out, the replacement cost new of the subject's proposed improvements is **\$69,400,000**, equivalent to **\$171.50/sq. ft. of gross building area**.

Replacement Cost New- Owner's Estimate

As states in previous sections of this report, the owner of the subject furnished a cost estimate for the proposed project, which is summarized in the next table.

SUMMARY OF PROJECT COST	
Hard Construction Cost	
General Condition & Fees	\$4,226,583
Sitework	\$20,899,622
Cold Warehouse	\$23,610,593
Administrative and Support Building	\$7,885,334
Dry Warehouse	\$11,617,983
Design Cost	\$3,376,552
Total Hard Cost	\$71,616,667
Soft Construction Cost	
Project Management & Consultant Costs	\$3,209,500
Construction Taxes	\$3,500,574
Site & Governm. Improvements	\$2,030,867
Technology & Security Infrastructure	\$3,200,000
Insurance	\$711,137
Permit & Other Expenses	\$111,656
Legal Fees	\$276,900
Design 30%/60%	\$1,784,323
Allowances	\$188,462
B2B (4%)	\$1,124,922
Closing & Other Fees	\$926,552
Unforeseen Contingencies	\$2,325,575
Total Soft Cost	\$19,390,467
Total Project Cost	\$91,007,133
Total Project Cost/GBA; As Completed	\$224.90

The total project cost was reported at **\$91,007,133**, and it excludes items such as land acquisition, racks, office furniture, capitalized interest cost, and forklifts equipment. Total project cost is equivalent at a rounded **\$225/sq.ft. of gross building area**, or \$216/sq. ft. of gross construction area. The reported cost includes all direct and indirect cost, including all site work and permit process. Yet, careful consideration must be given to the reported project cost as it is typically known that this type of owner-use/large-scale warehouse include design and construction components for the specific use of their current user.



**PROPOSED ECONO DISTRIBUTION CENTER
SOUTH OF ROAD PR-3, KM 16.2
CANOVANILLAS WARD, CANÓVANAS, PUERTO RICO**

Market Data

In order to provide further support to our estimate of replacement cost new for the subject existing improvements, we also gathered information about some industrial projects (warehouse) currently being carried out, or completed within the past recent years.

Local Data

Our research of market data indicates that several market players have invested in conversion of the existing facilities to add some cold storage warehouse spaces, including headquarters of Pueblo Supermarket, Caribbean Produce, Plaza Food System, Selectos Supermarket, and Century Frozen Foods, among others. Out of these market activities, we could obtain the following data.

- **Caribbean Produced Facilities:** Invested about ***\$86/sq.ft.*** in expansion of cold storage warehouse space and remodeling the office space. According to information obtained, the remodel work included acquisition of second hand (used) insulated wall panels and cooling equipment.
- **Pueblo Supermarket:** They are investing about ***\$140/sq.ft.*** in conversion of 9,594 sq. ft. dry warehouse space into cold (cooler/freezer) storage warehouse area. This project started on year 2020.
- **Selectos Supermarket:** On May 2021 the company announced a \$10million investment on expansion of their facilities to add 125,000 sq. ft., 22 loading doors. This is equivalent to ***\$80/sq.ft.***, and information gathered does not indicates if includes any cold storage warehouse area.
- **Plaza Food System:** The company just started a remodel and expansion of their facilities to add cold storage warehouse space, convert existing cold warehouse into dry warehouse area and remodel office space. The project was reported to have a total cost of ***\$150/sq.ft.*** of total proposed gross building area, with ***\$175/sq.ft.*** for the direct construction cost of the cold storage warehouse (cooler/freezer). The \$175/sq.ft. figure does not include indirect construction cost or site work.

The information above states project costs ranging from \$80/sq. ft. to \$175/sq.ft. However, they refer to remodel/expansion of existing facilities and not a fully new development, like subject's. Furthermore, subject lot is considerably bigger than the lots of the projects listed above because owner of the subject property visions an expansion of the facilities in the future. This expansion vision entails that the site was prepared for such future expansion, leaving two site areas already prepared for such expansion.

National Data

In addition to the above, since all market data gathered points towards the cold storage warehouse being an industry currently growing all over the U.S., we also made a research for project being develop in the U.S., which are discussed below.

- On December 2020, it was announced by Cold Summit Development the construction of a 343,000 sq.ft cold storage warehouse in Dallas, Texas, at a ***\$60million investment, equal to \$175/sq.ft. of building area.*** Yet, the space does not include major office space at it is a mutli-tenant building in which each tenant will built its office space according to their needs. Amenities include state fo the art refrigeration technology and 50' clear height.
- NewCold announced on November 2020 the construction of a 384,300 sq. ft. cold storage facility in Indiana at a ***\$99million investment, equivalent to \$258/sq.ft. of building area.*** Developer will also invest about \$50million in tenant's equipments, in addition to the \$99million.



**PROPOSED ECONO DISTRIBUTION CENTER
SOUTH OF ROAD PR-3, KM 16.2
CANOVANILLAS WARD, CANÓVANAS, PUERTO RICO**

- FreezPak announced on November 2020 the construction of a 140,000 sq. ft. state of the art freezer warehouse facility. The project will require a ***\$34million investment, equivalent to \$243/sq.ft.***

Replacement Cost New Reconciliation and Conclusion

In order to estimate subject's replacement cost new, our analysis included reported project cost, local market data, national data and an estimate with Marshall and Swift cost.

In the end, as stated previously, it is typically known that this type of owner-use/large-scale warehouse include design and construction components for the specific use of their current user. As such, it is considered that subject actual replacement cost new should be lower than the \$225/sq.ft. reported by the owner of the subject property.

On the other hand, Marshall and Swift data goes in-line with local data of project being carried for a similar use. This local data found provided indications up to \$175/sq.ft. for construction of a cold storage warehouse component within an existing facility.

However, taking into consideration that subject refers to a completely new project and all local data found refers to remodel/expansion of existing facilities, it is considered that subject replacement cost new estimate should be higher than the upper end of \$175/sq.ft. reflected by the local data found.

In conclusion, based on all data analyzed, we conclude with a total replacement cost new for the subject project of \$200/sq.ft. This indication is higher than the local data found and lower than subject's reported cost, recognizing the specific use nature of some components within this type of facilities. Yet, the \$200/sq.ft. indication also falls well within the national data found of new cold storage warehouse facilities being developed throughout the U.S.

With this in mind, subject replacement cost new is estimated as follows.

REPLACEMENT COST NEW ESTIMATE	
Gross Building Area (Sq.Ft.)	404,660
RCN Unitary Conclusion	\$200.00
Total Replacement Cost New	\$80,932,006

Entrepreneurial Incentive

Entrepreneurial incentive is an element for proposed developments/projects because it reflects the fact that developers would construct the improvements to earn a profit. This typical entrepreneurial incentive ranges between 10% to 20%, and is for projects/properties in which the owner hires a general contractor that share some of the risk associated with the construction process.

However, in subject's case, we must consider that these facilities are commonly developed for owner-use, which commonly built the property with entrepreneurial incentive/profit expectation from the business to be operated in the property rather than from the construction/development process. Therefore, no line item of entrepreneurial incentive will be considered in our analysis.

Accrued Depreciation

There are three categories of accrued depreciation. These are known as Physical Deterioration, Functional Obsolescence, and External Obsolescence.



**PROPOSED ECONO DISTRIBUTION CENTER
SOUTH OF ROAD PR-3, KM 16.2
CANOVANILLAS WARD, CANÓVANAS, PUERTO RICO**

Physical deterioration is the loss in utility of the property due to impairment of the physical condition that accompanies the aging of the improvements. In this case, subject refers to a proposed commercial/retail facility to be built, which redounds in subject "As Completed" being in as-new condition. Therefore, no physical depreciation is considered applicable.

Functional obsolescence is a loss in value resulting from defects in design, or by changes that have made some aspects of the structure obsolete by current standards. Based on subject characteristics and market trends for this type of facilities, it was concluded that the subject property does not suffer functional obsolescence.

In the case of external obsolescence, although it is known that in several markets' properties are being sold for less than their actual replacement cost new, careful consideration must be given to current market trends observed for this type of distribution/cold storage warehouse facilities.

Our research shows that after COVID-19 pandemic situation there was already an increase in demand for cold storage warehouse facilities and that such demand increased considerably after COVID-19. According to research by JLL and published on September 2020, the increase in demand for new facilities increased because of several factors, including most existing cold storage warehouse facilities (about 78% in the U.S.) are dated and non-efficient. According to CBRE, other factors that have helped increased demand for cold storage facilities include (1) increase in e-commerce of groceries, (2) as e-commerce grows, retailers are needing more storage & fulfillment space, (3) increase in restaurants demand for delivery-take out dining option, requiring more cold storage capacity, (4) increase in automation for order fulfillment that requires more storage capacity to keep-up demand of automation systems, and (5) strategic mergers & acquisitions that requires more storage capacities.

All of the above is even more clear for our local market because we have been also affected by COVID-19, our e-commerce has also increase considerably, clients/consumers have changed in their preferences and we are an island in which over 81% of the food that we consumed is imported.

The above is demonstrated by the current actions of local market participants like Selectos Supermarket, Plaza Food System, Century Frozen Foods and Pueblo Supermarket, among others. These market participants are currently investing in expansion/remodel/repairs to their facilities in dollar figures that currently exceeds the historical transactions of industrial properties acquired for similar uses.

The above fact demonstrates that such historical sales of industrial properties for similar use do not reflect current market trends that are clearly shown in recent actions of these market participants.

With this in mind, it is considered that given subject historical cost versus the replacement cost new estimated herein along with current market trends, no external obsolescence will be considered in our analysis, neither we will consider any depreciation for subject existing improvements.



**PROPOSED ECONO DISTRIBUTION CENTER
SOUTH OF ROAD PR-3, KM 16.2
CANOVANILLAS WARD, CANÓVANAS, PUERTO RICO**

Conclusion

As such, following is a summary of the Cost Approach:

SUMMARY OF THE COST APPROACH	
Total Replacement Cost New	\$80,932,006
<i>Less:</i> Depreciation	\$0
Depreciated Cost of Improvements	\$80,932,006
<i>Plus:</i> Value of Land*	\$1,650,000
Value by Cost Approach- "As Completed"	\$82,582,006
	Rounded to \$82,600,000

Also "As-Is" value indication

The cost approach was developed by first estimating the market value of the site, assuming it vacant and available to be put to its highest and best use as of the effective date of the appraisal. The replacement cost new of the proposed improvements was estimated with the Marshall & Swift Cost Manual indicators, cost estimate furnished by the owner of the property and other cost sources.

In conclusion, the subject's "As-Completed" market value indication provided by the Cost Approach for the fee simple interest in the proposed industrial facility, as of August 1, 2021, is expected to be **\$82,600,000**.



SALES COMPARISON APPROACH; “AS-COMPLETED”

The Sales Comparison Approach is the process in which a value estimate is obtained by analyzing and adjusting sales of properties similar to the subject. The comparative analysis in this approach focuses on differences in property rights transferred vs. appraised, financing terms, conditions of sale, and market conditions at the time of sale, location, and physical characteristics.

The Sales Comparison Approach is applicable to all property types and interests when there are sufficient, reliable transactions to indicate value patterns or trends in the market. When data is available, this is the most direct and systematic approach to estimate value. A general outline of the Sales Comparison Approach follows:

- Research the market to obtain information on sales transactions, listings, and offers to purchase and sell properties that are similar to the subject in terms of property type, date of sale, size, location, etc.
- Verify the information by confirming that the data is factually accurate and that the transactions reflect arm's-length market considerations.
- Select relevant units of comparison and develop a comparative analysis for each unit.
- Compare the sale properties with the subject using the elements of comparison and adjust the sale price of each comparable appropriately to the subject.
- Reconcile the various indications estimated from the analysis of the comparables into a single value indication or a range of values.

Subject Valuation

This valuation approach assumes an active market for the subject type of property as a basis for the extraction of data which might support a value conclusion. However, our market research did not reveal any recent truly comparable sale of a similar industrial facility, which could be considered similar/competitive in terms of condition, quality of construction, location, use and size. As such, the sales comparison approach was not developed. However, its development was not considered necessary to produce credible results.



**PROPOSED ECONO DISTRIBUTION CENTER
SOUTH OF ROAD PR-3, KM 16.2
CANOVANILLAS WARD, CANÓVANAS, PUERTO RICO**

RECONCILIATION AND FINAL VALUES ESTIMATE

In this appraisal assignment one of the three approaches to value were developed to form our opinion of value for the fee simple interest in the subject "As-Completed" scenario. Details of the analysis carried out is included below.

Site Valuation

Given the market data available and property characteristics, the site value process was carried out as part of the Cost Approach and was developed via the sales comparison approach technique. We analyzed information on site transactions that are similar in terms of property highest and best use, date of sale, size, location, etc. We verified the information by confirming that the data be factually accurate and that the transactions reflect arm's-length market considerations.

The most recent sales of vacant sites found were listed, analyzed and adjusted to arrive to an indication of value for the subject site. Given property characteristics and market data gathered, the unitary indication used was \$/cuerda. The site value process is considered to be adequately supported, resulting in a reliable indication of subject's site value.

Cost Approach

In the case of the Cost Approach, this was developed or the "As-Completed" scenario and accounts for site value and the cost of the proposed improvements. Given the nature of the assignment, the Replacement Cost New of the subject's proposed improvements was estimated based on information furnished by the Marshall and Swift Valuation Service, the project cost provided by the owner of the property and other cost sources. After considering the applicable entrepreneurial incentive, if any, the value of the site was added to the depreciated cost figure of the improvements to obtain the indication of value for the subject property under the "As-Completed" scenario.

"As-Completed" Value Conclusion

Based on the preceding information and analysis, we are of the opinion that the prospective market value "As Completed" for the fee simple interest in the subject proposed industrial facility as of August 1, 2021; is expected to be:

\$82,600,000.00
(EIGHTY-TWO MILLION SIX HUNDRED THOUSAND DOLLARS)



**PROPOSED ECONO DISTRIBUTION CENTER
SOUTH OF ROAD PR-3, KM 16.2
CANOVANILLAS WARD, CANÓVANAS, PUERTO RICO**

"AS-IS" VALUE INDICATION

As established throughout this report, subject project is in its final stages, which was reported as the final punch list of project details. The project was reported to be completely finished no later than August 2021 and owner representative indicated that \$721,050 are left to be invested to complete the project.

Thus, taking into consideration the short period and the small amount needed to be invested to complete the project, the "As-Is" value indication will be develop by only deducting the amount left to be invested to complete the project from the "As-Completed" value conclusion. Next is the table that summarizes the calculation.

"As-Completed" Value Conclusion	\$82,600,000
<i>Less:</i> Cost to Complete Project	\$721,050
"As-Is" Value Indication	<u>\$81,878,950</u>
Rounded to	\$81,900,000

Conclusion

In summary, we conclude that the market value of the fee simple interest in the subject property, as of May 12, 2021 and in its "As Is" condition, was **\$81,900,000**.



PROPOSED ECONO DISTRIBUTION CENTER
SOUTH OF ROAD PR-3, KM 16.2
CANOVANILLAS WARD, CANÓVANAS, PUERTO RICO

CERTIFICATION

We certify that to the best of our knowledge and belief:

- The statements of fact contained in this report are true and correct.
- The reported analyses, opinions and conclusions are limited only by the reported assumptions and limiting conditions and are our personal, impartial, and unbiased professional analyses, opinions, and conclusions.
- We have no present or prospective interest in the property that is the subject of this report, and we have no personal interest with respect to the parties involved.
- We have not performed appraisal services regarding the property that is the subject of this report within the three-year period immediately preceding acceptance of this assignment.
- We have no bias with respect to the property that is the subject of this report or to the parties involved with this assignment.
- Our engagement in this assignment was not contingent upon developing or reporting predetermined results.
- Our compensation for completing this assignment is not contingent upon the development or reporting of a predetermined value or direction in value that favors the cause of the client, the amount of the value opinion, the attainment of stipulated result, or the occurrence of a subsequent event directly related to the intended use of this appraisal.
- Our analyses, opinions, and conclusions were developed, and this report has been prepared, in conformity with the Uniform Standards of Professional Appraisal Practice.
- Mr. Juan José Jiménez, MAI made an exterior/drive-by inspection and Mr. Luis P. Matos made complete interior/exterior inspection of the property that is the subject of this report.
- No one provided significant real property appraisal assistance to the persons signing this certification.
- The reported analyses, opinions, and conclusions were developed, and this report has been prepared, in conformity with the Code of Professional Ethics and Standards of Professional Appraisal Practice of the Appraisal Institute.
- The use of this report is subject to the requirements of the Appraisal Institute relating to review by its duly authorized representatives.
- As of the date of this report, Juan José Jiménez, MAI has completed the requirements under the continuing education program of the Appraisal Institute.

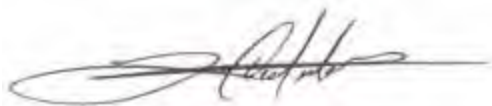

Luis P. Matos Colón
State License No. 1346EPA
Certified General Certificate No. 365CG



Juan José Jiménez, MAI
State License No. 691EPA
Certified General Certificate No. 166CG



**PROPOSED ECONO DISTRIBUTION CENTER
SOUTH OF ROAD PR-3, KM 16.2
CANOVANILLAS WARD, CANÓVANAS, PUERTO RICO**

GENERAL ASSUMPTIONS

This appraisal report has been made with the following general assumptions:

1. No responsibility is assumed for the legal description or for matters including legal or title considerations. Title to the property is assumed to be good and marketable unless otherwise stated.
2. The property is appraised, free and clear of any and all liens or encumbrances unless otherwise stated. All taxes are assumed to be current. In specific cases, at the request of the client, the appraiser may present data on past due ad valorem taxes. However, this data is not certified and is only a verbal confirmation by the tax authority. This data should not be relied upon by the client and has no effect on the final value estimate.
3. The property is appraised as though under responsible, adequately capitalized ownership and competent property management.
4. The information furnished by others is believed to be reliable. However, no warranty is given for its accuracy.
5. All engineering is assumed to be correct. The plot plans and illustrative material in this report are included only to assist the reader in visualizing the property.
6. It is assumed that there are no hidden or unapparent conditions of the property, subsoil, or structures that render it less valuable. No responsibility is assumed for such conditions or for arranging for engineering studies that may be required to discover them.
7. It is assumed that there is full compliance with all applicable federal, state, and local environmental regulations and laws unless noncompliance is stated, defined, and considered in the appraisal report.
8. It is assumed that all applicable zoning and use regulations and restrictions have been complied with, unless nonconformity has been stated, defined, and considered in the appraisal report.
9. It is assumed that all required licenses, certificates of occupancy, consents, or other legislative or administrative authority from any local, state, or national government or private entity or organization have been or can be obtained or renewed for any use on which the value estimate contained in this report is based.
10. It is assumed that the utilization of the land and improvements is within the boundaries or property lines of the property described and that there is no encroachment or trespass unless noted in the report.
11. The availability of capacity and/or connection rights to any or all public utilities has not been determined by the appraiser. The value estimate reported herein is contingent upon and limited to said capacity and right of connection.



**PROPOSED ECONO DISTRIBUTION CENTER
SOUTH OF ROAD PR-3, KM 16.2
CANOVANILLAS WARD, CANÓVANAS, PUERTO RICO**

GENERAL LIMITING CONDITIONS

1. The appraisers will not be required to give testimony or appear in court because of having made this appraisal, with reference to the property in question, unless arrangements have been previously made thereof.
2. Any cause of action resulting between the appraiser and the client in conjunction with this appraisal, either directly or indirectly, will be limited in damages to the amount of the appraisal fee received for the assignment. Furthermore, it is agreed that you will indemnify JJ Jiménez & Associates, Juan J. Jiménez Acevedo and Luis P. Matos Colón for any damages, costs, expense, and attorney's fees resulting from any cause of action by any interested party, other than the client, concerning the appraisal or report.
3. In the case where an improvement is considered, the distribution of the total valuation between land and improvements applies only under the reported highest and best use of the property. The allocations of value for land and improvements must not be used in conjunction with any other appraisal and are invalid if so used.
4. Disclosure of the contents of this report is governed by the By-Laws and Regulations of the Appraisal Institute. Neither all nor any part of the contents of this report, or copy thereof, shall be conveyed to the public through advertising, public relations, news, sales or any other media without written consent and approval of the appraiser(s). Nor shall the appraisers, firm or professional organization of which the appraisers are members be identified without prior written consent of the appraisers.
5. The physical condition of the improvements described herein is based on visual inspection only. No liability is assumed for the soundness of structural components including roof (wear and leakage), foundation (settling or leakage), footings, exterior and interior walls, partitions, floors, or any other part of the structure, since no engineering tests were made of same and no termite inspection was conducted. Furthermore, the appraisers accept no legal responsibility for the efficiency of the plumbing and electrical systems, the heating and air conditioning equipment, or any major appliances. Unless otherwise noted, all of these items appeared adequate and operational.
6. In this appraisal assignment, the existence of potentially hazardous material used in the construction or maintenance of the building, such as the presence of urea formaldehyde foam insulation or asbestos, and/or existence of toxic waste, which may or may not be present on the property, has not been considered. The appraisers are not qualified to detect such substances. The client is urged to retain an expert in this field if desired.
7. The Americans with Disabilities Act (ADA) became effective January 26, 1992. We have not made a specific compliance survey or analysis of this property to determine whether or not it is in conformity with the various detailed requirements of the ADA. It is possible that a compliance survey of the property, together with a detailed analysis of the requirements of the ADA, could reveal that the property is not in compliance with one or more of the requirements of the Act. If so, this fact could have a negative impact upon the value of the property. Since there is no direct evidence relating to this issue, we did not consider possible non-compliance with the requirements of ADA in estimating the value of the property.
8. The appraisers are not aware of the presence of archaeological deposits and/or artifacts within the subject or in adjacent properties. The physical inspection of the property did not reveal any evidence of such deposits and/or artifacts; however, the appraisers are not qualified to detect archeological deposits and/or artifacts and assume no responsibility in this respect. The value reported herein and the estimated construction and/or marketing time for the property are predicated on the assumption that the subject does not have any such archeological artifacts.



PROPOSED ECONO DISTRIBUTION CENTER
SOUTH OF ROAD PR-3, KM 16.2
CANOVANILLAS WARD, CANÓVANAS, PUERTO RICO

ADDENDUM

- Engagement Letter
- Qualifications



**PROPOSED ECONO DISTRIBUTION CENTER
SOUTH OF ROAD PR-3, KM 16.2
CANOVANILLAS WARD, CANÓVANAS, PUERTO RICO**



PO Box 362708
San Juan, PR 00936-2708
(787) 765-9800

May 4, 2021

REAL ESTATE
REVIEW SERVICES,
CORP.
URB. EL PILAR D-18,
CALLE QUEBRADA
ARENAS, SAN JUAN,
PR 00926-5451

RE: 94236
Supermercados Econo, Inc.
Brief Property Description: Industrial

Dear Juan J. Jiménez,

We hereby request your services for the performance of an appraisal report for the property located on:

**Canóvanas and Pueblo Wards
State Road PR-3, Km. 16.2**

Puerto Rico, Canóvanas

Intended Use: Commercial Credit Administration

Intended User(s): Banco Popular de Puerto Rico (BPPR reserves the right to use the report for purposes of syndication with other financial institutions or securitization).

The appraisal report shall include the following value(s), to be developed in accordance with the value definitions as established by the Appraisal Institute and/or the Interagency Appraisal and Evaluation Guidelines:

VALUE TYPE

Market Value

Liquidation Value

Replacement Cost New*

*Replacement Cost New, if required, should be based on refined base cost and exclude land, depreciation, entrepreneurial profit and additional indirect costs. IMPORTANT: If property consists of separate structures, please indicate the replacement cost for each structure separately.

EFFECTIVE DATE OF VALUE PERSPECTIVE

As-Is (On Appraiser's Date of Inspection)

Prospective Value Upon Completion

Prospective Value Upon Stabilized Occupancy

REPORTING OPTION

Appraisal Report

Form Report

The appraisal report should be submitted by email in full-color pdf (with photos and addendas).

The appraisal report will have to meet the minimum standards described under the "Uniform Standards of Professional Appraisal Practice" (USPAP) and Title XI of the "Financial Institutions Reform, Recovery and Enforcement Act" of 1989 (FIRREA). The appraisal must also meet the following standards of content and reporting:

Appraisal must include sufficient current market information to support the value conclusion. For those cases in which grouping of the lots is necessary for the functionality of the appraised property, this assumption should be enhanced and properly discussed and analyzed for underwriting and valuation purposes.

Please include an signed copy of this Engagement Letter in your report.

The appraisal report should be submitted to AppraisalDeliveries@popular.com on or before 5 PM, 06/01/2021.

Once received, the appraisal report will be subject to an appraisal review. Should we require clarification or corrections to the submitted appraisal report, you agree to respond promptly to our requests. Any corrections or amendments to the appraisal report resulting from our review process shall be at no additional cost to the Bank.

As agreed, fees for your services, payable upon our acceptance of your appraisal report, will be . To this fee, a service tax (if applicable) will be applied and included as a separate amount in your invoice for these appraisal services. The calculation of the service tax percentage will be based on the tax rate in effect as of the date of the appraisal report.

Should you have any questions, please feel free to contact us at (787) 765-9800. Jennifer Martir Suarez, of our Appraisal Ordering and Review Department, will be your principal point of contact with regards to this appraisal report. She may be reached by e-mail at jennifer.martir@popular.com. You may also

June 1, 2021•



J.J. JIMÉNEZ & ASSOCIATES
Real Estate Appraisers & Consultants

• Page No. 71

**PROPOSED ECONO DISTRIBUTION CENTER
SOUTH OF ROAD PR-3, KM 16.2
CANOVANILLAS WARD, CANÓVANAS, PUERTO RICO**

contact Ms. Nellie Ramirez, Ordering Supervisor, at Nellie.Ramirez@popular.com.

We appreciate your services, and look forward to receiving the appraisal report on or before the agreed date.

Banco Popular Appraisal Ordering

Agreed and Accepted By: _____

Title: _____

Print Name: Juan José Jiménez

Date: 5/5/2021

Comments:

(787) 620-9292 (787) 396-8984

FAVOR DE PONER EL LIQUIDATION VALUE EN UN ADDENDUM APARTE DE LA TASACION

Non-revolving lines of credit will be converted into term loan(s). Previous "as-proposed" appraisal is included for reference.



**PROPOSED ECONO DISTRIBUTION CENTER
SOUTH OF ROAD PR-3, KM 16.2
CANOVANILLAS WARD, CANÓVANAS, PUERTO RICO**

QUALIFICATIONS-LUIS P. MATOS COLÓN

EXPERIENCE

Real Estate Appraiser - Responsibilities included appraising different types of real estate initially as an appraiser assistant. Assignments covered include the following: residential, commercial, industrial, vacant sites, residential subdivisions, gas stations, hotels, shopping centers, office buildings, nursing homes, small commercial buildings and other special-purpose properties. Associated with J. J. Jiménez & Associates, Corp. since July 2011.

Real Estate Appraiser Assistant - (2003 to 2011) – Responsibilities included assist in the valuation of residential and commercial real estate. Type of properties valued includes small residential income, single-family residential properties, vacant land, proposed residential developments, hotels, office buildings, nursing homes, shopping centers and warehouse facilities. Associated with Beverley and Associates, PSC.

PROFESSIONAL LICENSES & DESIGNATIONS

Federal General Certified Real Estate Appraiser No. 365, Commonwealth of Puerto Rico
State Licensed Real Estate Appraiser, License No. 1346EPA, Commonwealth of Puerto Rico
Valuation of Sustainable Green Buildings: Residential- Registered Appraiser

EDUCATION

University of Puerto Rico **Carolina, Puerto Rico**
Bachelor's in science of Business Administration, Finance concentration.

Continuous Education – Recent courses include:
Real Estate Appraisal Courses and Seminars within past 4 years:

- 7 Hour National USPAP (12/20)
- Leyes & Reglamentos (02/20)
- Case Studies in Appraising Green Buildings (01/2019)
- Introducing to Green Buildings (01/2019)
- Real Estate Economics after María (12/2018)
- Insurance Appraisal & 50% FEMA Rule (11/2018)
- 7 Hour National USPAP (01/18)
- Hurricane Damaged Economics. Real Estate Damages (04/2018)
- 7 Hour National USPAP (01/17)
- Forecasting Revenue (01/17)
- Leyes & Reglamentos (12/16)
- Qualitative Analyses in the Sales Comparison Approach (03/15)



**PROPOSED ECONO DISTRIBUTION CENTER
SOUTH OF ROAD PR-3, KM 16.2
CANOVANILLAS WARD, CANÓVANAS, PUERTO RICO**



QUALIFICATIONS – JUAN JOSE JIMENEZ, MAI

EXPERIENCE

J.J. JIMENEZ & ASSOCIATES, San Juan, Puerto Rico

Owner - (November 1999 to Present) – Real Estate Consultant and Appraiser: responsibilities include consulting, reviewing, and appraising real estate; including hotels, hospitals, shopping centers, car dealerships, parking garages, office buildings, manufacturing buildings, warehouse facilities, schools and university facilities, residential projects (rental, condos, second homes, senior housing, student housing), gasoline service stations, bowling centers, retail buildings, billboards, institutional buildings (nursing homes, rehab centers & courthouses), marinas, coffee roasting facilities, agricultural farms, dairy farms, land leases, and vacant sites.

APPRAISAL INSTITUTE

Chicago, Illinois

Faculty - (February 2006 to 2011) – Approved Instructor for the following courses: Appraisal Principles, Appraisal Procedures, Sales Comparison, Land Valuation and Cost Approach, Residential Site Valuation and Cost Approach, Residential Sales Comparison, Residential Income Capitalization, Residential Market Analysis and Highest & Best Use.

DESARROLLADORA LIRIOS, S.E.

San Juan, Puerto Rico

Real Estate Developer & Broker – (August 1993 to November 1999) – Responsible for planning, marketing, financing and development of residential projects

Real Estate Appraiser - (August 1993 to November 1999) – Responsibilities included appraising commercial real estate, including hotels, office buildings, manufacturing & warehouse facilities, residential projects, and vacant sites. Subcontractor for McCloskey, Mulet & Bonnin Appraisers, Diaz-Molina & Associates, Vallejo & Vallejo, and Ruben Cintrón & Associates

BANCO POPULAR DE PUERTO RICO

San Juan, Puerto Rico

Corporate Real Estate Division

Real Estate Broker - (September 1990 to August 1993) - Responsible for marketing, negotiation and the administration of approximately 1,000,000 square feet of retail and office spaces across the Island. Also responsible for acquisition, leasing, administration and disposition of properties used by the Bank for its operations

Information Systems Analyst - (July 1989 to September 1990) - Responsible for the analysis, design, and implementation of computer systems and procedures for the Division

Human Resources Division

Administrative Assistant Information Systems Department - (August 1987 to July 1989) - Responsibilities included maintaining all information systems in the Division, except for Payroll. Established the Information Systems Department.

PROFESSIONAL LICENSES

Federal General Certified Real Estate Appraiser No. 166, Commonwealth of Puerto Rico
Real Estate Appraiser No. 691, Commonwealth of Puerto Rico



**PROPOSED ECONO DISTRIBUTION CENTER
SOUTH OF ROAD PR-3, KM 16.2
CANOVANILLAS WARD, CANÓVANAS, PUERTO RICO**

EDUCATION

Appraisal Institute

Chicago, Illinois

MAI Designation, Valuation of Commercial, Industrial, Residential and Real Estate Investment
- April 2005

Washington University

St. Louis, Missouri

Bachelor in Science of Business Administration, Finance concentration - May 1987

Continuous Education – Recent courses & seminars (past 4 years) include:

- Appraisal Institute’s Businesses Practices & Ethics (12/20)
- Protocolo Tasadores de Bienes Raíces - COVID-19 Web Seminar (5/20)
- 7Hour National Uniform Standards of Professional Appraisal Practice (1/20)
- How Tenants Create or Destroy, Value: Leasehold Valuation and Its Impact on Value (11/19)
- Parking and its Impact on Puerto Rico Properties (4/19)
- Residential and Commercial Valuation of Solar (3/19)
- FEMA 50% Rule and Insurance Appraisals (11/18)
- Puerto Rico Appraisal Laws and Regulations (7/18)
- 7Hour National Uniform Standards of Professional Appraisal Practice (5/18)
- Uniform Standards for Federal Land Acquisition (5/18)
- Real Estate Damages: Analyzing the Impact of the Hurricane (4/18)

MEMBER AND OFFICES HELD

- Hogar Padre Venard (Service Center for the Homeless)
Board of Directors (2017 – 2020)
Volunteer at Las Duchas at La Perla (2013 – 2016)
- Parroquia María Madre de la Misericordia (Church)
Member of the Economic Council (2016 – 2020)
- Appraisal Institute (member since 2000)
Discussion Leader for the Leadership Development & Advisory Council (2006)
Member of the Leadership Development and Advisory Council (2003 - 2005)
- Puerto Rico & Caribbean Chapter of the Appraisal Institute (member since 2000)
Past President (2007-2008)
President (2006)
Vice President and Government Relationship Committee Chair (2005)
Government Relationship Committee (2003 & 2004)
Treasurer (2001 & 2002)

AWARDS

- 2008 Appraiser of the Year – Puerto Rico & Caribbean Chapter of the Appraisal Institute
- 2008 Professor of the Year – Puerto Rico & Caribbean Chapter of the Appraisal Institute
- Outstanding Participant Award in recognition for excellent contributions during the Appraisal Institute’s Leadership Development and Advisory Council (2003)
- Banco Popular Recognition of Extraordinary Efforts (1992)
- Banco Popular Excellence Award (1989 & 1991)



**PROPOSED ECONO DISTRIBUTION CENTER
SOUTH OF ROAD PR-3, KM 16.2
CANOVANILLAS WARD, CANÓVANAS, PUERTO RICO**

PARTIAL LIST OF CLIENTS

Popular Inc & Banco Popular Puerto Rico	Gatsby GA Investors
FirstBank & FirstMortgage	American Parking Systems
Scotiabank Puerto Rico	Hostería del Mar Hotel & Restaurant
Scotiabank Dominican Republic	Guánica Village Partners, LLC
Citibank	USA Capital Management
Santander Bank Puerto Rico	Matosantos Commercial / EuroCaribe
Banco Bilbao Vizcaya Argentaria	Miguel Arán & Associates
Oriental Bank	Ariel Conde & Associates, PSC
Bayview Asset Management	Desarrollos Roig
Blackpoint Partners	The Outlet Malls Canóvanas
Banesco USA	Encanto Restaurants
Banco Cooperativo de Puerto Rico	Casa de Los Tornillos / Fuerza Industrial
Municipio de Bayamón	Aireko Construction Management
Municipio de San Juan	Estate Jose Nolla Morell
Grant Thornton CPA's	Estate Jose Rivera Rivera
Benigno Fernández & Associates, CPA's	Estate Rexach Sánchez-Vahamonde
O'Neill & Borges Law Offices	Estate Zaida Reyes Silva
Polo & Polo Law Offices	Estate Manuel Fernos Lopez
Rivera Rivera, Rivera Torres Law	Empresas Masso
Pietrantonio Méndez Alvarez Law	Target Point, Inc.
McConnell Valdés Law Offices	Marina Salinas, Inc.
Morell Cartagena & Dapena Law	Insignia Living of Puerto Rico, Inc.
Guzmán & Rodríguez-López Law Office	Starlight Development
Moore & Van Allen Law Office	Robles Asphalt & Ready Mix
Ferraiouli Law Office	Wyndham Carib Development Company
Miller Zeiderman & Wiederkehr Law	Allied Management Group
Pulte Homes	Creative Development
Kaman Industrial Technologies	MForce Professional Land Surveyors
Chicago Title Insurance Company	Manila Apartments Inc.
AMECO	Isla Lab Puerto Rico / Caribbean
Bristol-Myers Squibb Company	EJE Realty (DDB Latina Puerto Rico)
McCormack Baron Salazar, Inc.	PR Industrial Development Company
Colliers International	Palmas Hills Partners, LLC
Diestra Consulting Group	Toyota Puerto Rico, Corp.
Acrecent Financial Corporation	Frank Motors, Inc.
B&N Asset Management	Caribbean Produce Exchange
Brisas del Caribe Santo Domingo Trust	PR Asset Portfolio Servicing International
One Trust Home Loans	Union Holdings Puerto Rico
Altamira Developers, S.E.	ACRUVA Capital Partners
Eye Surgery Specialist of P.R.	PRCI Loan CFL, LLC
Triple S Management	Quantum Spot Media
Kingbird Investment Management	Muñoz Holdings, Inc.
PG Engineering Solutions, P.S.C.	GUSO & ToGo Stores
Universidad Ana G Mendez	GFR Media
Cooperativa San José	Forward Learning Corp.
Caribbean Airport Facilities	San Juan Airport Hotel
Plaza Guayama, S.E.	AC Escorial Ford



Appendix 4:
Wetland Map

Appendix 8

Wetland Map

Econo Energy Project

Project ID: IPGM-00375

Address: State Road PR-3, Int. PR 9959, Km. 15.21 Bo.





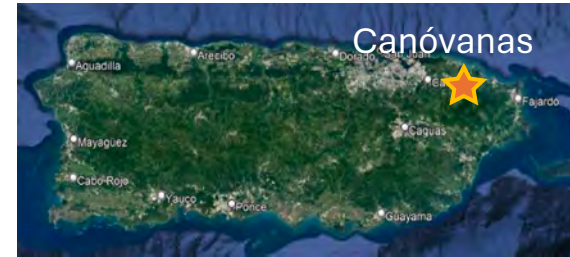



Canovanillas, Canóvanas, PR. 00729

Coordinates: 18.373613° -65.906549° 



May 19, 2024

Wetlands

- | | | |
|--|---|--|
|  Estuarine and Marine Deepwater |  Freshwater Emergent Wetland |  Lake |
|  Estuarine and Marine Wetland |  Freshwater Forested/Shrub Wetland |  Other |
| |  Freshwater Pond |  Riverine |

This map is for general reference only. The US Fish and Wildlife Service is not responsible for the accuracy or currentness of the base data shown on this map. All wetlands related data should be used in accordance with the layer metadata found on the Wetlands Mapper web site.

Source: <https://www.fws.gov/program/national-wetlands-inventory/wetlands-mapper>

National Wetlands Inventory (NWI)
This page was produced by the NWI mapper

Appendix 5:
Jurisdictional Wetland Determination Study 2016

Jurisdictional Wetland and U.S. Waters Determination Study



**Supermercados Econo
New Warehouse and
Distribution Center
Canóvanas, Puerto Rico**

**Prepared for:
Supermercados Econo,
Inc.**

Prepared by:



Environmental Studies,
Permitting and Consulting

**September 2016
San Juan, Puerto Rico**



Table of Contents

Executive Summary	1
Introduction.....	3
Study Site Description	4
Rainfall.....	4
Topography	4
Hydrology	4
Soils.....	4
National Wetland Inventory	6
Methodology	7
Results and Discussion	9
Vegetation.....	9
Soils.....	10
Hydrology	10
Uplands	10
Conclusions.....	13
References.....	14
Appendix A: Figures.....	16
Figure 1: Site Location Map (1:20,000)	17
Figure 2: Aerial Photograph (1:20,000).....	18
Figure 3: Aerial Photograph (1:4,000).....	19
Figure 4: Hydrographic Map (1 :20,000).....	20
Figure 5: Soil Map (1 :4,000)	21
Figure 6: National Wetland Inventory Map (1:4,000)	22
Figure 7: Jurisdictional Wetlands Determination Map (2010 Aerial Photo).....	23
Figure 8: Jurisdictional Wetlands overlaid on a Recent Topographic Study.....	24
Appendix B: Photographic Documentation	25
Appendix C: Data Forms	26

Executive Summary

Supermercados Econo, Inc. has retained the services of Coll Rivera Environmental to perform a Wetlands and U.S. Waters Jurisdictional Determination Study (JD) in a parcel of land (the study site) of approximately 77.1 acres (79.2 “cuerdas”). This parcel of land is located in to the south side of PR-3 Km. 16.2 in the Pueblo Ward in the Municipality of Canóvanas (**Appendix A, Figures 1 and 2**).

This document represents the Wetlands and U.S. Waters Jurisdictional Determination Study for the study site. The methodology employed for this study consisted first in a preliminary screening process and background information gathering to determine the potential jurisdictional wetlands within the study site. Then, a detailed screening using Geographic Information System (GIS) and data collected at the field identified those wetland and other areas that potentially are under the jurisdiction of the United States Army Corps of Engineers (USACE). The **Methodology** section of this report describes the employed methodology in more detail.

Jurisdictional wetlands were found within the study limit. Wetland Area A contains approximately 627.5 m² (0.16 acres), and Wetland Area B includes approximately 23,622.5 m² (5.83 acres). **Figure 7 (Appendix A)** shows the Wetlands and U.S. Waters Jurisdictional Determination Map for this Project. The delineated wetlands can be classified as palustrine, emergent, persistent, seasonally flooded (PEM1C).

Most common wetland plant species on these wetlands include hierba Venezolana (*Paspalum fasciculatum*), cohítre (*Commelina diffusa*), frijol silvestre (*Vigna luteola*) and bejuco de puerco (*Ipomoea indica*).

In terms of hydric soil indicators, 10YR and was the most abundant soil hue, as expected. Low chroma soils (value of two or less) were common within wetlands. Most common hydric soil indicator found is the presence of Hydrogen Sulfide.

Most common wetland hydrology indicators were high water table, inundation, saturation, and FAC-neutral test.

Introduction

Supermercados Econo, Inc. has retained the services of Coll Rivera Environmental to perform a Wetlands and U.S. Waters Jurisdictional Determination Study (JD) in a parcel of land (the study site) of approximately 77.1 acres (79.2 “cuerdas”). This parcel of land is located in to the south side of PR-3 Km. 16.2 in the Pueblo Ward in the Municipality of Canóvanas (**Appendix A, Figures 1 and 2**).

The Project proposes the development a new warehouse and distribution center for the Supermercados Econo .

This document represents the Wetlands and U.S. Waters Jurisdictional Determination Study for the study site. The methodology employed for this study followed the 1987 Corps of Engineers Wetland Delineation Manual, and the Regional Supplement to the Corps of Engineers Wetland Delineation Manual: Caribbean Islands Region (version 2.0) (the Caribbean supplement). It first included a preliminary screening and background information gathering to determine the potential jurisdictional wetlands within the study site. Then, a detailed screening using Geographic Information System (GIS) and data collected at the field identified those wetland areas that are under the jurisdiction of the USACE. The **Methodology** section of this report describes the employed methodology in more detail.

This report is organized into four sections: a site description, methodology, results and discussion, and conclusions and recommendations. **Appendix A** contains topographic, aerial imagery, hydrographic, National Wetland Inventory, and soil survey maps. The Jurisdictional Wetlands and U.S Waters delineation figure was overlaid on aerial images (2010 and 2015) of the area. Photographic documentation of the wetland areas is included in **Appendix B**. **Appendix C** includes the Data Forms from the Caribbean supplement.

The field work for this JD was performed in September 2016.

Study Site Description

The study site is located in to the south side of PR-3 Km. 16.2 in the Pueblo Ward in the Municipality of Canóvanas (**Appendix A, Figures 1 and 2**). It is bordered to the north by State Road PR-3; to the east by Plaza Rial Shopping Center and other commercial lots; to the south with the Hipódromo Camarero; and to the west with the Hipódromo Avenue.

Rainfall

According to the National Climatic Data Center (NCDC), average rainfall for the region is 77.30 inches (1932.5 mm). This data is the average rainfall between 1981 and 2010. The wettest months of the year are May and from August to November. Data was taken from the Canóvanas station.

Topography

According to the topographic quadrangles of Carolina and Gurabo (USGS), the study site is within 5 and 40 meters above mean sea level. **Figure 1** shows the study site over the topographic quadrangles.

Hydrology

The most important hydrographic feature within the study site is the Quebrada Bocaforma. The Quebrada Bocaforma discharges into the Río Grande de Loíza (see **Figure 4**). The Río Grande de Loíza discharges into the Atlantic Ocean.

Soils

According to the U.S. Department of Agriculture's Soil Conservation Service, the soils within study site are classified as Mabi clay, Caguabo clay loam, and Gravel Pit (**Appendix A, Figure 5**). **Table 1** includes the description of these soils.

Table 1. Description of soils within study site*

Soil Survey Area	Soil	Landform	Slope	Drainage Class	Frequency of Flooding	Frequency of Ponding	Depth to Water Table	Hydric?
Humacao	Caguabo clay loam (CbF2)	Mountains, hills	20 to 60%	Well drained	None	None	More than 80 inches	No
	Mabi clay (MaB)	Alluvial fans, terraces	0 to 5%	Somewhat poorly drained	None	None	18 to 36 inches	Yes
	Mabi clay (MaC2)	Alluvial fans, terraces	5 to 12%	Somewhat poorly drained	None	None	18 to 36 inches	No
	Mabi clay (MaD2)	Alluvial fans, terraces	12 to 20%	Somewhat poorly drained	None	None	18 to 36 inches	No
	Gravel, Pits, Quarries (G.P.)	N/A	N/A	N/A	N/A	N/A	N/A	N/A

*United States Department of Agriculture, Soil Conservation Service.

National Wetland Inventory

The National Wetland Inventory (NWI), prepared by the U.S. Fish and Wildlife Service (USFWS) classifies an area to the north of the study site as palustrine, emergent, persistent, seasonally flooded (PEM1C).

It is important to mention that the NWI was performed in the 70's decade. Today, there are wetlands that are not included in the NWI. On the other hand, there are areas classified as wetlands under the NWI that are not wetlands in the present. This study has been updated in year 2016; however, the new edition has not changed from the '70's edition for the study site.

Methodology

The methodology employed during this study followed the Routine Determination with an onsite inspection method, as described in the *1987 Corps of Engineers Wetland Delineation Manual* (the Manual) for areas greater than 5 acres in size, and the Regional Supplement to the Corps of Engineers Wetland Delineation Manual: Caribbean Islands Region (version 2.0) (the Caribbean supplement).

In areas where differences between the Manual and the Caribbean supplement occurred, the Caribbean supplement took precedence. There were areas that determination was difficult, due to past or recent land use, or other reasons. In those cases, determination was based on the best information available, interpreted in light of professional experience and knowledge of the ecology of wetlands in the area, as stated in the Caribbean supplement.

This JD was performed in three phases. Phase 1 of the study was a screening level analysis to identify those areas within the site that show wetland characteristics. The screening analysis was performed using a Geographical Information System (GIS). This analysis included aerial imagery from different years, soils map, National Wetland Inventory map, hydrographic map, and topographic map. The data gathered from this phase provided specific and important information on the location of possible wetland areas. This phase included a preliminary site visit to know the environmental conditions of the study site. It also helped in providing a better understanding of the wetland condition and location in order to develop a fieldwork plan.

Phase II of the study included the delineation field visits to map the jurisdictional wetlands on the site. Each delineation visit consisted on the sampling, collection, and description of the site's hydrology, soils, and dominant vegetation around representative sampling locations on established transects.

The following tasks were carried out during Phase II:

- Visual inspection of the site and identification of landscape features;
- Identification of plant communities;
- Selection of a representative area within each plant community to dig a soil pit;
- Identification of dominant plant species from the various strata;
- Characterization of the soil properties and colors in the soil pit;
- Measure of depth where hydric soil indicators (if any) appear;
- Description of the hydrology around and within the soil pit;
- Photographic documentation of the site, soil pits or vegetation;
- Geographic Positioning System (GPS) documentation of sampling points; and
- Wetland delineation and documentation of wetland limits.

For the determination of the wetland indicator status of plant species, the 2016 Wetland Plant List was used as reference.

To determine soil colors (hue, value and chroma), as well as for estimating proportions of redoxiphormic features the Munsell Soil Color Charts (2000) was used as reference.

Phase III of the study comprised the final analysis of the data gathered during Phases I and II and the development of this report.

Results and Discussion

Jurisdictional wetlands were found within the study limit. Wetland Area A contains approximately 627.5 m² (0.16 acres), and Wetland Area B includes approximately 23,622.5 m² (5.83 acres). **Figure 7 (Appendix A)** shows the Wetlands and U.S. Waters Jurisdictional Determination Map for this Project. The delineated wetlands can be classified as palustrine, emergent, persistent, seasonally flooded (PEM1C).

The Quebrada Bocaforma crosses a section of the study area from south to north along its eastern side. This hydrographic feature was not delineated apart from its associated wetlands given that it does not show open waters. Its canal has been colonized and covered mostly by hierba Venezolana (*Paspalum fasciculatum*) and malanguilla (*Colocasia esculenta*).

Vegetation

Most common wetland plant species on the delineated wetlands include hierba Venezolana (*Paspalum fasciculatum*), cohítre (*Commelina diffusa*), frijol silvestre (*Vigna luteola*) and bejuco de puerco (*Ipomoea indica*).

Table 2 includes the dominant plant species within wetlands, with their respective indicator.

Table 2. Dominant plant species within wetlands

Scientific Name	Common Name	Stratum	Indicator*
<i>Paspalum fasciculatum</i>	hierba Venezolana	Herbaceous	FACW
<i>Commelina diffusa</i>	cohítre	Herbaceous	FAC
<i>Ipomoea indica</i>	bejuco de puerco	Herbaceous	FAC
<i>Vigna luteola</i>	frijol silvestre	Herbaceous	FAC

*FACW: Facultative wetland species (usually occurs in wetlands, but may occur in non-wetlands); FAC: Facultative species (occurs in wetlands and non-wetlands).

Within the study site, 23% of sampling points showed wetland vegetation (FACW or FAC). In average, wetland vegetation dominated 83% over other species (FACU or UPL) that do not occur frequently on wetlands. 100% of plant species dominating wetlands are FACW or FAC.

Soils

The study area has been disturbed by past and present uses. However, wetland areas seem to be undisturbed.

In terms of hydric soil indicators, 10YR and was the most abundant soil hue, as expected. Low chroma soils (value of two or less) were common within wetlands. Most common hydric soil indicator found is the presence of Hydrogen Sulfide.

Hydrology

Due to the topographic variation between wetlands and the surrounding elevations most of the wetlands were inundated, saturated or water table was found close to soil surface. Most common wetland hydrology indicators were high water table, inundation, saturation, and FAC-neutral test.

Uplands

Uplands within the study site are found mostly to the west and south of Project site. These areas have been used as a quarry for many years.

Some plant species shown in **Table 2** were also present in upland areas. **Table 3** includes other species found within uplands.

Table 3. Dominant Plant Species within Uplands

Scientific Name	Common Name	Stratum	Indicator
<i>Paspalum fasciculatum</i>	Yerba venezolana	Herbaceous	FACW
<i>Megathyrsus maximus</i>	Zarza	Herbaceous	FACU

Albizia procera

Bejuco de puerco

Herbaceous

UPL

* FACU: Facultative Upland Species (Usually occurs in non-wetlands, but may occur in wetlands). UPL: Upland Species (almost never occur in wetlands).

Most upland areas showed no hydric soils indicators, or at least at the required depth. Wetland hydrology indicators were absent, or just one secondary wetland hydrology indicator was found.

Sampling point EC-17 is located on an earthen canal. This canal manages storm water and discharges it into the northern wetland via a steel pipe. However, this canal was dug from uplands before 1971 when activities for earth crust extraction took place in the north and northwestern areas of study site. It does not appear in the topographic quadrangles of the study site. Therefore, it is our opinion that it is not jurisdictional.

Figures 6 and 7 show the Jurisdictional Wetlands and U.S. Water Determination Map for the study site. **Table 4** includes the sampling point's coordinates within the study area.

Table 4. Sampling points coordinates*

Sampling Point ID number	Sampling Point Location*	
	x	y
EC-1	255,875.015	259,953.932
EC-2	255,919.462	259,939.803
EC-3	255,925.970	259,939.420
EC-4	255,945.111	259,940.186
EC-5	255,961.189	259,838.356
EC-6	256,025.502	259,942.100
EC-7	256,036.987	259,938.654
EC-8	255,631.967	260,088.336
EC-9	255,632.349	260,113.219
EC-10	255,642.685	260,131.211
EC-11	255,630.435	260,151.118
EC-12	255,449.746	260,121.258
EC-13	259,948.232	259,948.250
EC-14	255,692.455	259,998.348
EC-15	255,817.866	259,683.213

Sampling Point ID number	Sampling Point Location*	
	x	y
EC-16	255,468.738	259,524.792
EC-17	255,533.000	260,161.578

*Referenced to State Plane NAD 83

Conclusions

This Jurisdictional Wetland Determination Study concludes that both delineated wetlands within the study site should be considered under the jurisdiction of the U.S. Army Corps of Engineers, by virtue of Section 404 of the Clean Water Act of 1972, as amended.

These two wetlands are (see **Figure 7, Appendix A**):

1. Wetland Area A containing approximately 627.5 m² (0.16 acres).
2. Wetland Area B containing approximately 23,622.5 m² (5.83 acres).

This conclusion is supported by:

1. Presence of hydrophytic vegetation, hydric soils and wetland hydrology.
2. Existing wetlands are directly abutting relatively permanent, non-navigable tributaries of traditional navigable waters.

References

- Acevedo-Rodríguez, P. and Woodbury, R. O. **1985**. *Los bejucos de Puerto Rico*. Volumen 1. General Technical Report S0-85. New Orleans, LA: U.S. Department of Agriculture, Forest Service, Southern Forest Experiment Station. 331 pp.
- Boccheciamp, R.A. **1982**. *Soil Survey of Humacao Area of Puerto Rico*. U.S.D.A. Soil Conservation Service. 180 pp. plus appendices.
- Department of Natural and Environmental Resources, et al. **2001**. *Guide to Identify Common Wetland Plants in the Caribbean Area: Puerto Rico and the U.S. Virgin Islands*. Editorial de la Universidad de Puerto Rico. 268 pp.
- Environmental Laboratory. **1987**. *Corps of Engineers Wetlands Delineation Manual*. U.S. Army Engineer Waterways Experimental Station, Vicksburg, M.S. Tech. Rpt. Y-87-1. 100 pp. plus appendices.
- Environmental Laboratory. **2011**. *Regional Supplement to the Corps of Engineers Wetland Delineation Manual: Caribbean Islands Region (version 2.0)*. U.S. Army Engineer Research and Development Center, Vicksburg, M.S. ERDC/EL TR-09-8. 119 pp. plus appendices.
- GretagMacbeth. **2000**. *Munsell Soil Color Charts*. Munsell Color, New Windsor, NY.
- Hutchinson, Ian. 1988. *Salinity Tolerance of Plants of Estuarine Wetlands and Associated Uplands*. Washington State Shorelands and Coastal Zone Management Program: Wetlands Section. Report in fulfillment of contract No. C0088137.
- Liogier, H. A. **1985**. *Descriptive Flora of Puerto Rico and adjacent islands*. Volumes I-V. Editorial de la Universidad de Puerto Rico, Río Piedras, PR.
- Little, E. L. and Wadsworth, F. H. **1964**. *Common Trees of Puerto Rico and the Virgin Islands*. Agricultural Handbook No. 249. U.S. Department of Agriculture, Forest Service. Washington, D.C. 556 pp.
- Más, E.G. and García Molinari, O. **1990**. *Guía Ilustrada de Yervas Comunes en Puerto Rico*. Servicio de Extensión Agrícola, Universidad de Puerto Rico, Recinto Universitario de Mayagüez, Colegio de Ciencias Agrícolas. 103 pp.
- Ramey, Víctor. **2001**. *Grasses, Sedges and Rushes of Wetlands*. Identification Deck. With notes about wildlife use. University of Florida. Institute of Food and Agricultural Sciences. 85 pp.

Tiner, Ralph W. **1999**. *Wetland Indicators: a guide to wetland identification, delineation, classification, and mapping*. CRC Press LLC. 363 pp.

United States Department of Agriculture. Soil Conservation Service. Caribbean Area. San Juan Puerto Rico. **1993**. *Hydric Soils of the Caribbean*. In Cooperation with the National Technical Committee for Hydric Soils.

Appendix A: Figures

Figure 1: Site Location Map (1:20,000)

FIGURE 1: SITE LOCATION MAP (1:20,000)

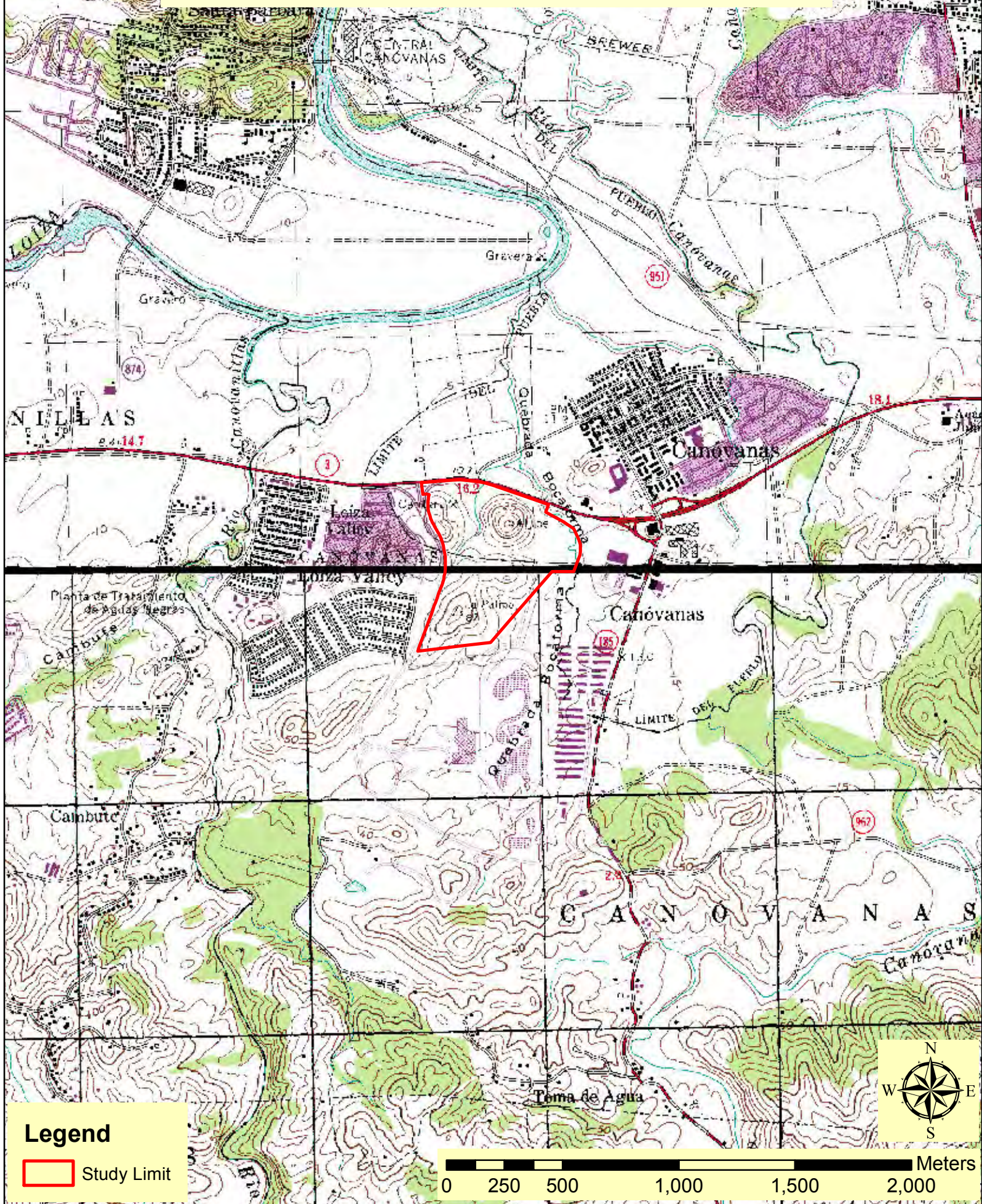

Figure 2: Aerial Photograph (1:20,000)

FIGURE 2: AERIAL PHOTO (1:20,000)

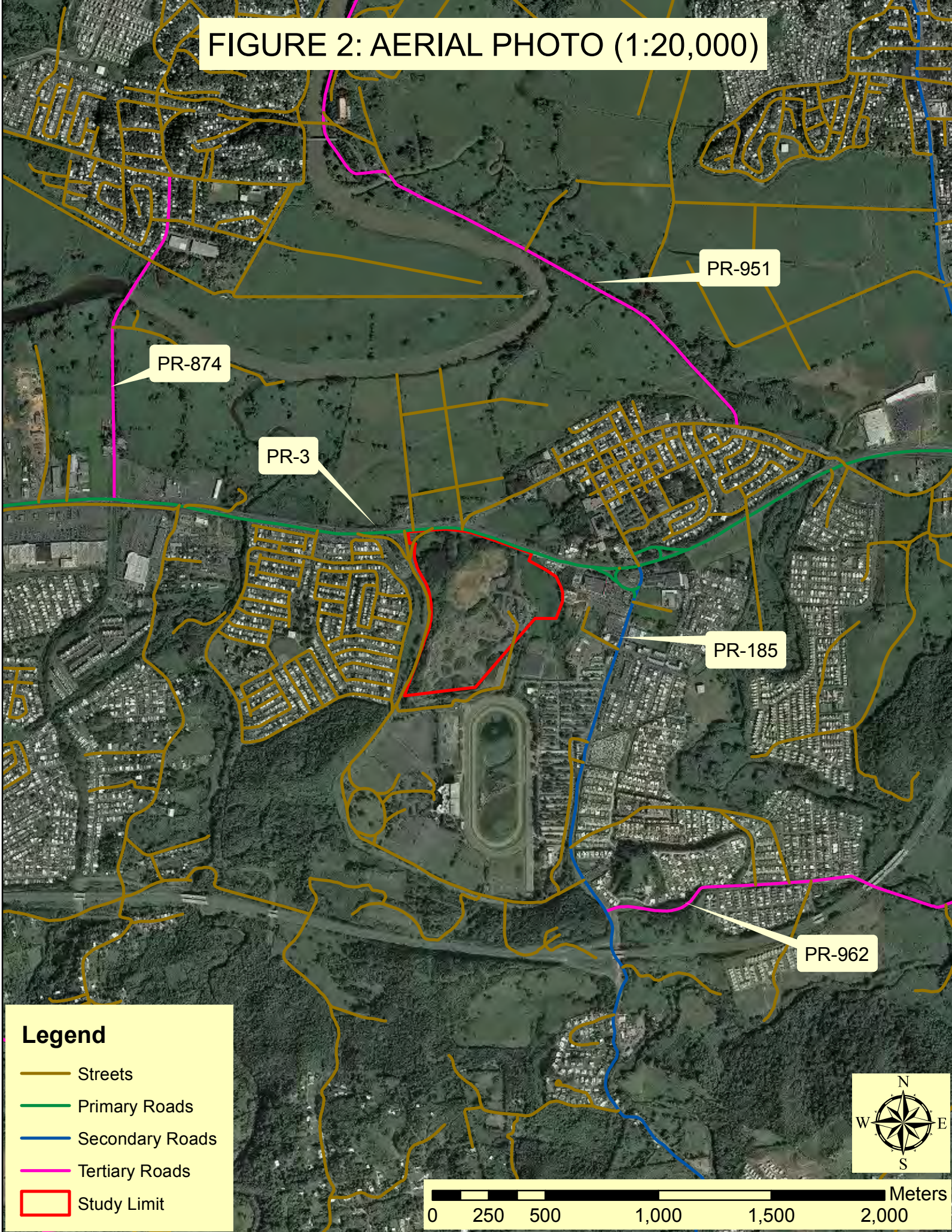



Figure 3: Aerial Photograph (1:4,000)

FIGURE 3: AERIAL PHOTO (1:4,000)



Legend

 Study Limit

0 50 100 200 300 400 Meters



Figure 4: Hydrographic Map (1 :20,000)

FIGURE 4: HYDROGRAPHIC MAP (1:20,000)

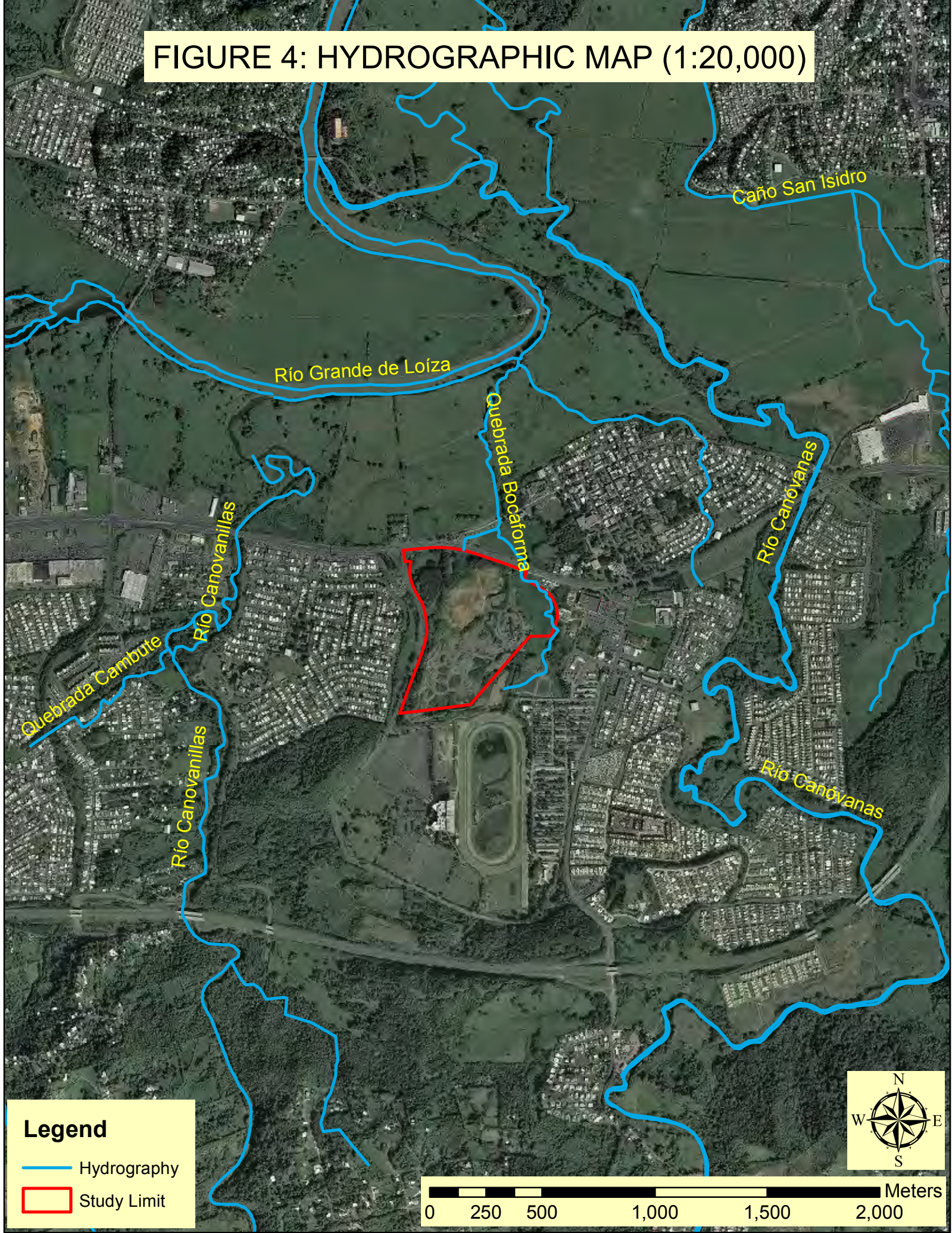

Legend

- Hydrography
- ▭ Study Limit

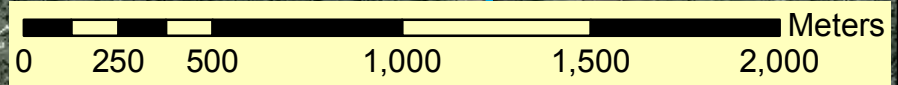

Figure 5: Soil Map (1 :4,000)

FIGURE 5: SOILS MAP (1:4,000)



Legend

- Soils
- Study Limit

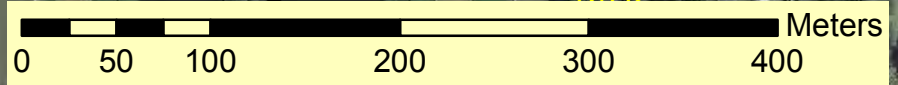



Figure 6: National Wetland Inventory Map (1:4,000)

PEM1F

FIGURE 6: NATIONAL WETLAND INVENTORY MAP (1:4,000)



Legend

-  National Wetland Inventory
-  Study Limit

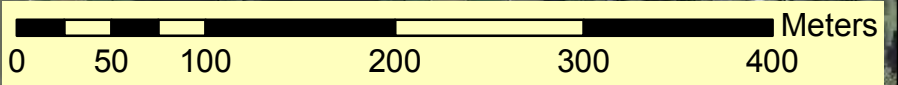
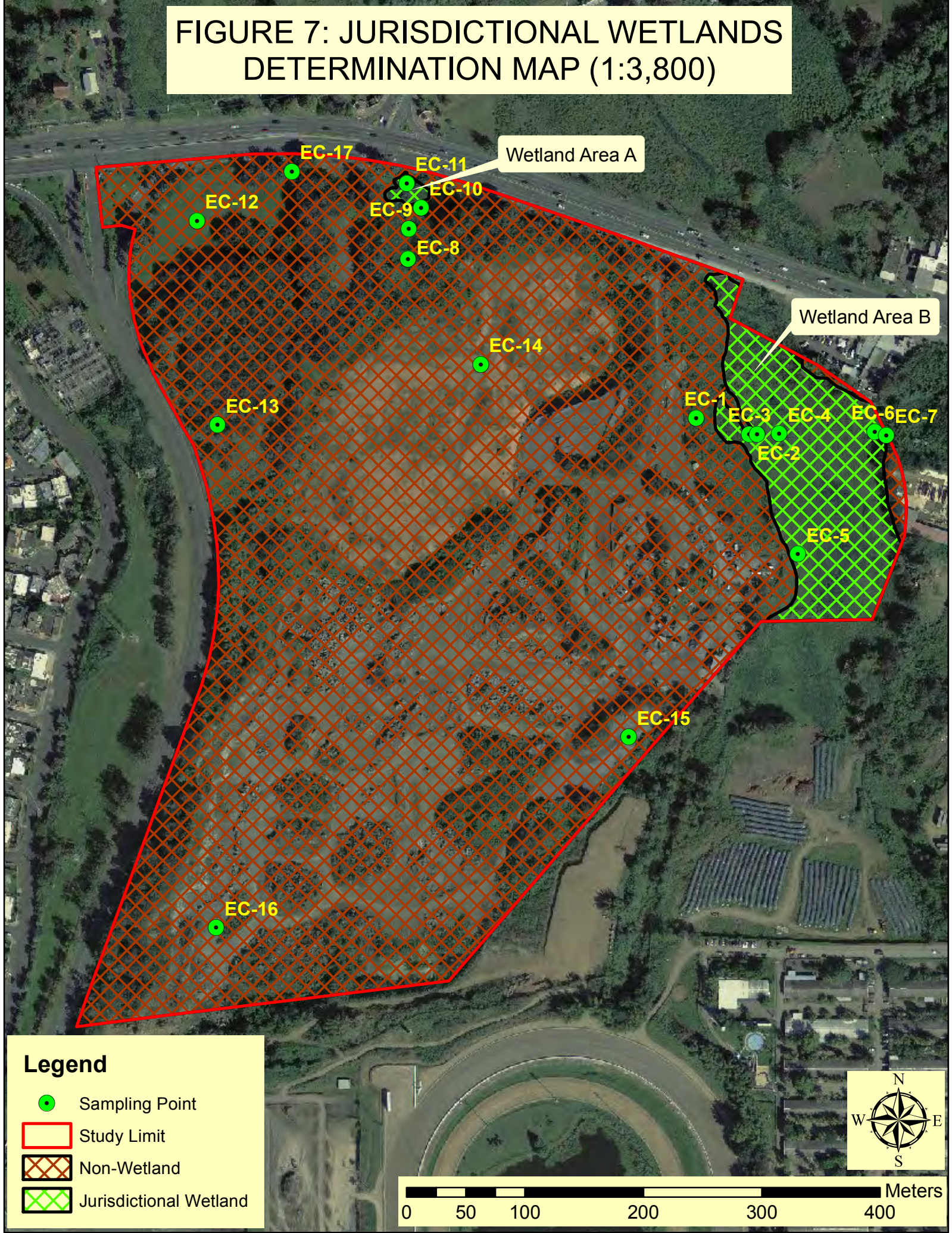

Figure 7: Jurisdictional Wetlands Determination Map (2010 Aerial Photo)

FIGURE 7: JURISDICTIONAL WETLANDS DETERMINATION MAP (1:3,800)



Legend

- Sampling Point
- ▭ Study Limit
- ▨ Non-Wetland
- ▨ Jurisdictional Wetland

0 50 100 200 300 400 Meters



Figure 8: Jurisdictional Wetlands overlaid on a Recent Topographic Study

Appendix B: Photographic Documentation



Photo 1. Sampling point EC-1 area.



Photo 2. Sampling point EC-1 soil pit.



Photo 3. Sampling point EC-2 area.



Photo 4. Sampling point EC-2 soil pit.



Photo 5. Sampling point EC-3 area.



Photo 6. Sampling point EC-3 soil pit.



Photo 7. Sampling point EC-4 area.



Photo 8. Sampling point EC-4 soil pit.



Photo 9. Sampling point EC-5 area.



Photo 10. Sampling point EC-5 soil pit.



Photo11. Sampling point EC-6 area.



Photo 12. Sampling point EC-6 soil pit.



Photo 13. Sampling point EC-7 area.



Photo 14. Sampling point EC-7 soil pit.



Photo 15. Sampling point EC-8 area.



Photo 16. Sampling point EC-8 soil pit.



Photo 17. Sampling point EC-9 area.



Photo 18. Sampling point EC-9 soil pit.



Photo 19. Sampling point EC-10 area.



Photo 20. Sampling point EC-10 soil pit.



Photo 21. Sampling point EC-11 area.



Photo 22. Sampling point EC-11 soil pit.



Photo 23. Sampling point EC-12 area.



Photo 24. Sampling point EC-12 soil sample.



Photo 25. Sampling point EC-13 area.



Photo 26. Sampling point EC-13 soil view.



Photo 27. Sampling point EC-14 area.



Photo 28. Another view of sampling point EC-14 area. Soil condition is shown.



Photo 29. General view of sampling point EC-15 area.



Photo 30. Another view of sampling point EC-15 area.



Photo 31. General view of sampling point EC-16 area.



Photo 32. Another view of sampling point EC-16 area.



Photo 33. Sampling point EC-17 area.



Photo 34. Another view of sampling point EC-17 area.



Photo 35. General view where the Quebrada Bocaforma and associated wetland reach the southeastern boundary of the study limit.



Photo 36. General view of the wetlands associated to the Quebrada Bocaforma to the eastern side of the study site.



Photo 37. Point where the Quebrada Bocaforma discharges under the PR-3 towards north.



Photo 38. General view of the wetland to the north of the study limit.

Appendix C: Data Forms

WETLAND DETERMINATION DATA FORM – Caribbean Islands Region

Project/Site: Supermercados Econo New Warehouse and Distribution Center Municipality/Town: Canóvanas Sampling Date: September 7, 2016
 Applicant/Owner: Supermercados Econo, Inc. PR or USVI: PR Sampling Point: EC-1
 Investigator(s): Jorge L. Coll Rivera Ward/Estate: Pueblo
 Landform (hillslope, terrace, etc.): Terrace Local relief (concave, convex, none): none Slope (%): 0%
 Lat: 255,875.015 Long: 259,953.932 Datum: State Plane, NAD 83
 Soil Map Unit Name: Mabi clay (MaB) NWI classification: UPL

Are climatic / hydrologic conditions on the site typical for this time of year? Yes No (If no, explain in Remarks.)
 Are Vegetation , Soil , or Hydrology significantly disturbed? Are "Normal Circumstances" present? Yes No
 Are Vegetation , Soil , or Hydrology naturally problematic? (If needed, explain any answers in Remarks.)

SUMMARY OF FINDINGS – Attach site map showing sampling point locations, transects, important features, etc.

Hydrophytic Vegetation Present? Yes <input checked="" type="checkbox"/> No <input type="checkbox"/> Hydric Soil Present? Yes <input type="checkbox"/> No <input checked="" type="checkbox"/> Wetland Hydrology Present? Yes <input type="checkbox"/> No <input checked="" type="checkbox"/>	Is the Sampled Area within a Wetland? Yes <input type="checkbox"/> No <input checked="" type="checkbox"/>
---	---

Remarks:

Sampling point is located within a topographically high area.

VEGETATION – Use scientific names of plants.

Tree Stratum (Plot size: <u>30 feet radius</u>)	Absolute % Cover	Dominant Species?	Indicator Status	Dominance Test worksheet:
1. <u>N/A</u>				Number of Dominant Species That Are OBL, FACW, or FAC: <u>3</u> (A)
2. _____				Total Number of Dominant Species Across All Strata: <u>3</u> (B)
3. _____				Percent of Dominant Species That Are OBL, FACW, or FAC: <u>100%</u> (A/B)
4. _____				
5. _____				
_____ = Total Cover				Prevalence Index worksheet:
Sapling/Shrub Stratum (Plot size: <u>15 feet radius</u>)				Total % Cover of: _____ Multiply by: _____
1. <u>N/A</u>				OBL species _____ x 1 = _____
2. _____				FACW species _____ x 2 = _____
3. _____				FAC species _____ x 3 = _____
4. _____				FACU species _____ x 4 = _____
5. _____				UPL species _____ x 5 = _____
_____ = Total Cover				Column Totals: _____ (A) _____ (B)
Herb Stratum (Plot size: <u>5 feet radius</u>)				Prevalence Index = B/A = <u>N/A</u>
1. <u>Urochloa mutica</u>	<u>25%</u>	<u>Yes</u>	<u>FACW</u>	Hydrophytic Vegetation Indicators: <input type="checkbox"/> Rapid Test for Hydrophytic Vegetation <input checked="" type="checkbox"/> Dominance Test is >50% <input type="checkbox"/> Prevalence Index is ≤3.0 ¹ <input type="checkbox"/> Problematic Hydrophytic Vegetation ¹ (Explain)
2. <u>Commelina diffusa</u>	<u>40%</u>	<u>Yes</u>	<u>FAC</u>	
3. <u>Ipomoea indica</u>	<u>35%</u>	<u>Yes</u>	<u>FAC</u>	
4. _____				
5. _____				
6. _____				
7. _____				
8. _____				
_____ = Total Cover				Hydrophytic Vegetation Present? Yes <input checked="" type="checkbox"/> No <input type="checkbox"/>
Woody Vine Stratum (Plot size: <u>30 feet radius</u>)				
1. <u>N/A</u>				
2. _____				
3. _____				
4. _____				
_____ = Total Cover				

Remarks:

The 2016 Wetland Plant List was used to determine indicator status.

SOIL

Sampling Point: EC-1

Profile Description: (Describe to the depth needed to document the indicator or confirm the absence of indicators.)

Depth (inches)	Matrix		Redox Features				Texture	Remarks
	Color (moist)	%	Color (moist)	%	Type ¹	Loc ²		
0-7	10YR 3/2	100%					Clay	
7-14	10YR 5/6	100%					Clay	

¹Type: C=Concentration, D=Depletion, RM=Reduced Matrix, CS=Covered or Coated Sand Grains. ²Location: PL=Pore Lining, M=Matrix.

<p>Hydric Soil Indicators:</p> <input type="checkbox"/> Histosol (A1) <input type="checkbox"/> Histic Epipedon (A2) <input type="checkbox"/> Black Histic (A3) <input type="checkbox"/> Hydrogen Sulfide (A4) <input type="checkbox"/> Organic Bodies (A6) <input type="checkbox"/> 5 cm Mucky Mineral (A7) <input type="checkbox"/> Muck Presence (A8) <input type="checkbox"/> Depleted Below Dark Surface (A11) <input type="checkbox"/> Thick Dark Surface (A12)	<input type="checkbox"/> Sandy Gleyed Matrix (S4) <input type="checkbox"/> Sandy Redox (S5) <input type="checkbox"/> Stripped Matrix (S6) <input type="checkbox"/> Dark Surface (S7) <input type="checkbox"/> Loamy Gleyed Matrix (F2) <input type="checkbox"/> Depleted Matrix (F3) <input type="checkbox"/> Redox Dark Surface (F6) <input type="checkbox"/> Depleted Dark Surface (F7) <input type="checkbox"/> Redox Depressions (F8)	<p>Indicators for Problematic Hydric Soils³:</p> <input type="checkbox"/> Stratified Layers (A5) <input type="checkbox"/> Very Shallow Dark Surface (TF12) <input type="checkbox"/> Other (Explain in Remarks)
---	---	--

³Indicators of hydrophytic vegetation and wetland hydrology must be present, unless disturbed or problematic.

<p>Restrictive Layer (if observed): Type: <u>N/A</u> Depth (inches): <u>N/A</u></p>	<p>Hydric Soil Present? Yes <input type="checkbox"/> No <input checked="" type="checkbox"/></p>
--	---

Remarks:

No hydric soil indicators were found at this sampling point.

HYDROLOGY

<p>Wetland Hydrology Indicators:</p> <p><u>Primary Indicators (minimum of one required; check all that apply)</u></p> <input type="checkbox"/> Surface Water (A1) <input type="checkbox"/> High Water Table (A2) <input type="checkbox"/> Saturation (A3) <input type="checkbox"/> Water Marks (B1) <input type="checkbox"/> Sediment Deposits (B2) <input type="checkbox"/> Drift Deposits (B3) <input type="checkbox"/> Algal Mat or Crust (B4) <input type="checkbox"/> Iron Deposits (B5) <input type="checkbox"/> Inundation Visible on Aerial Imagery (B7)			<p><u>Secondary Indicators (minimum of two required)</u></p> <input type="checkbox"/> Surface Soil Cracks (B6) <input type="checkbox"/> Sparsely Vegetated Concave Surface (B8) <input type="checkbox"/> Drainage Patterns (B10) <input type="checkbox"/> Dry-Season Water Table (C2) <input type="checkbox"/> Saturation Visible on Aerial Imagery (C9) <input type="checkbox"/> Geomorphic Position (D2) <input type="checkbox"/> Shallow Aquitard (D3) <input type="checkbox"/> FAC-Neutral Test (D5)		
<p><u>Other Indicators:</u></p> <input type="checkbox"/> Water-Stained Leaves (B9) <input type="checkbox"/> Aquatic Fauna (B13) <input type="checkbox"/> Hydrogen Sulfide Odor (C1) <input type="checkbox"/> Oxidized Rhizospheres on Living Roots (C3) <input type="checkbox"/> Presence of Reduced Iron (C4) <input type="checkbox"/> Recent Iron Reduction in Tilled Soils (C6) <input type="checkbox"/> Thin Muck Surface (C7) <input type="checkbox"/> Fiddler Crab Burrows (C10) <input type="checkbox"/> Other (Explain in Remarks)					

<p>Field Observations:</p> Surface Water Present? Yes <input type="checkbox"/> No <input checked="" type="checkbox"/> Depth (inches): _____ Water Table Present? Yes <input type="checkbox"/> No <input checked="" type="checkbox"/> Depth (inches): _____ Saturation Present? (includes capillary fringe) Yes <input type="checkbox"/> No <input checked="" type="checkbox"/> Depth (inches): _____	<p>Wetland Hydrology Present? Yes <input type="checkbox"/> No <input checked="" type="checkbox"/></p>
---	---

Describe Recorded Data (stream gauge, monitoring well, aerial photos, previous inspections), if available:

Remarks:

No wetland hydrology indicators were found at this sampling point.

WETLAND DETERMINATION DATA FORM – Caribbean Islands Region

Project/Site: Supermercados Econo New Warehouse and Distribution Center Municipality/Town: Canóvanas Sampling Date: September 7, 2016
 Applicant/Owner: Supermercados Econo, Inc. PR or USVI: PR Sampling Point: EC-2
 Investigator(s): Jorge L. Coll Rivera Ward/Estate: Pueblo
 Landform (hillslope, terrace, etc.): Terrace Local relief (concave, convex, none): none Slope (%): 1-3%
 Lat: 255,919.462 Long: 259,939.803 Datum: State Plane, NAD 83
 Soil Map Unit Name: Mabi clay (MaB) NWI classification: UPL

Are climatic / hydrologic conditions on the site typical for this time of year? Yes No (If no, explain in Remarks.)
 Are Vegetation , Soil , or Hydrology significantly disturbed? Are "Normal Circumstances" present? Yes No
 Are Vegetation , Soil , or Hydrology naturally problematic? (If needed, explain any answers in Remarks.)

SUMMARY OF FINDINGS – Attach site map showing sampling point locations, transects, important features, etc.

Hydrophytic Vegetation Present? Yes <input checked="" type="checkbox"/> No <input type="checkbox"/> Hydric Soil Present? Yes <input type="checkbox"/> No <input checked="" type="checkbox"/> Wetland Hydrology Present? Yes <input type="checkbox"/> No <input checked="" type="checkbox"/>	Is the Sampled Area within a Wetland? Yes <input type="checkbox"/> No <input checked="" type="checkbox"/>
---	---

Remarks:

Sampling point is located within a herbaceous area of low topography.

VEGETATION – Use scientific names of plants.

Tree Stratum (Plot size: <u>30 feet radius</u>)	Absolute % Cover	Dominant Species?	Indicator Status	Dominance Test worksheet:
1. <u>N/A</u>				Number of Dominant Species That Are OBL, FACW, or FAC: <u>2</u> (A)
2. _____				Total Number of Dominant Species Across All Strata: <u>2</u> (B)
3. _____				Percent of Dominant Species That Are OBL, FACW, or FAC: <u>100%</u> (A/B)
4. _____				
5. _____				
_____ = Total Cover				
Sapling/Shrub Stratum (Plot size: <u>15 feet radius</u>)				
1. <u>N/A</u>				Prevalence Index worksheet: Total % Cover of: Multiply by: OBL species <u>N/A</u> x 1 = _____ FACW species _____ x 2 = _____ FAC species _____ x 3 = _____ FACU species _____ x 4 = _____ UPL species _____ x 5 = _____ Column Totals: _____ (A) _____ (B) Prevalence Index = B/A = _____
2. _____				
3. _____				
4. _____				
5. _____				
_____ = Total Cover				
Herb Stratum (Plot size: <u>5 feet radius</u>)				
1. <u>Paspalum fasciculatum</u>	<u>10%</u>	<u>No</u>	<u>FACW</u>	Hydrophytic Vegetation Indicators: <input type="checkbox"/> Rapid Test for Hydrophytic Vegetation <input checked="" type="checkbox"/> Dominance Test is >50% <input type="checkbox"/> Prevalence Index is ≤3.0 ¹ <input type="checkbox"/> Problematic Hydrophytic Vegetation ¹ (Explain) ¹ Indicators of hydric soil and wetland hydrology must be present, unless disturbed or problematic.
2. <u>Commelina diffusa</u>	<u>50%</u>	<u>Yes</u>	<u>FAC</u>	
3. <u>Ipomoea indica</u>	<u>80%</u>	<u>Yes</u>	<u>FAC</u>	
4. _____				
5. _____				
6. _____				
7. _____				
8. _____				
<u>140%</u> = Total Cover				
Woody Vine Stratum (Plot size: <u>30 feet radius</u>)				
1. <u>N/A</u>				Hydrophytic Vegetation Present? Yes <input type="checkbox"/> No <input checked="" type="checkbox"/>
2. _____				
3. _____				
4. _____				
_____ = Total Cover				

Remarks:

The 2016 Wetland Plant List was used to determine indicator status.

SOIL

Sampling Point: EC-2

Profile Description: (Describe to the depth needed to document the indicator or confirm the absence of indicators.)

Depth (inches)	Matrix		Redox Features				Texture	Remarks
	Color (moist)	%	Color (moist)	%	Type ¹	Loc ²		
0-4	10YR 3/2	100%					Clay	
4-12	10YR 4/3+	100%					Clay	

¹Type: C=Concentration, D=Depletion, RM=Reduced Matrix, CS=Covered or Coated Sand Grains. ²Location: PL=Pore Lining, M=Matrix.

Hydric Soil Indicators:

- | | |
|--|---|
| <input type="checkbox"/> Histosol (A1) | <input type="checkbox"/> Sandy Gleyed Matrix (S4) |
| <input type="checkbox"/> Histic Epipedon (A2) | <input type="checkbox"/> Sandy Redox (S5) |
| <input type="checkbox"/> Black Histic (A3) | <input type="checkbox"/> Stripped Matrix (S6) |
| <input type="checkbox"/> Hydrogen Sulfide (A4) | <input type="checkbox"/> Dark Surface (S7) |
| <input type="checkbox"/> Organic Bodies (A6) | <input type="checkbox"/> Loamy Gleyed Matrix (F2) |
| <input type="checkbox"/> 5 cm Mucky Mineral (A7) | <input type="checkbox"/> Depleted Matrix (F3) |
| <input type="checkbox"/> Muck Presence (A8) | <input type="checkbox"/> Redox Dark Surface (F6) |
| <input type="checkbox"/> Depleted Below Dark Surface (A11) | <input type="checkbox"/> Depleted Dark Surface (F7) |
| <input type="checkbox"/> Thick Dark Surface (A12) | <input type="checkbox"/> Redox Depressions (F8) |

Indicators for Problematic Hydric Soils³:

- Stratified Layers (A5)
- Very Shallow Dark Surface (TF12)
- Other (Explain in Remarks)

³Indicators of hydrophytic vegetation and wetland hydrology must be present, unless disturbed or problematic.

Restrictive Layer (if observed):

Type: N/A
 Depth (inches): N/A

Hydric Soil Present? Yes No

Remarks:

No hydric soil indicators were found at this sampling point.

HYDROLOGY

Wetland Hydrology Indicators:

Primary Indicators (minimum of one required; check all that apply)

- | | |
|--|---|
| <input type="checkbox"/> Surface Water (A1) | <input type="checkbox"/> Water-Stained Leaves (B9) |
| <input type="checkbox"/> High Water Table (A2) | <input type="checkbox"/> Aquatic Fauna (B13) |
| <input type="checkbox"/> Saturation (A3) | <input type="checkbox"/> Hydrogen Sulfide Odor (C1) |
| <input type="checkbox"/> Water Marks (B1) | <input type="checkbox"/> Oxidized Rhizospheres on Living Roots (C3) |
| <input type="checkbox"/> Sediment Deposits (B2) | <input type="checkbox"/> Presence of Reduced Iron (C4) |
| <input type="checkbox"/> Drift Deposits (B3) | <input type="checkbox"/> Recent Iron Reduction in Tilled Soils (C6) |
| <input type="checkbox"/> Algal Mat or Crust (B4) | <input type="checkbox"/> Thin Muck Surface (C7) |
| <input type="checkbox"/> Iron Deposits (B5) | <input type="checkbox"/> Fiddler Crab Burrows (C10) |
| <input type="checkbox"/> Inundation Visible on Aerial Imagery (B7) | <input type="checkbox"/> Other (Explain in Remarks) |

Secondary Indicators (minimum of two required)

- Surface Soil Cracks (B6)
- Sparsely Vegetated Concave Surface (B8)
- Drainage Patterns (B10)
- Dry-Season Water Table (C2)
- Saturation Visible on Aerial Imagery (C9)
- Geomorphic Position (D2)
- Shallow Aquitard (D3)
- FAC-Neutral Test (D5)

Field Observations:

Surface Water Present? Yes No Depth (inches): _____
 Water Table Present? Yes No Depth (inches): _____
 Saturation Present? Yes No Depth (inches): _____
 (includes capillary fringe)

Wetland Hydrology Present? Yes No

Describe Recorded Data (stream gauge, monitoring well, aerial photos, previous inspections), if available:

Remarks:

No primary wetland hydrology indicators were found.

WETLAND DETERMINATION DATA FORM – Caribbean Islands Region

Project/Site: Supermercados Econo New Warehouse and Distribution Center Municipality/Town: Canóvanas Sampling Date: September 7, 2016
 Applicant/Owner: Supermercados Econo, Inc. PR or USVI: PR Sampling Point: EC-3
 Investigator(s): Jorge L. Coll Rivera Ward/Estate: Pueblo
 Landform (hillslope, terrace, etc.): Terrace Local relief (concave, convex, none): concave Slope (%): 0%
 Lat: 255,925.970 Long: 259,939.420 Datum: State Plane, NAD 83
 Soil Map Unit Name: Mabi clay (MaB) NWI classification: UPL

Are climatic / hydrologic conditions on the site typical for this time of year? Yes No (If no, explain in Remarks.)
 Are Vegetation , Soil , or Hydrology significantly disturbed? Are "Normal Circumstances" present? Yes No
 Are Vegetation , Soil , or Hydrology naturally problematic? (If needed, explain any answers in Remarks.)

SUMMARY OF FINDINGS – Attach site map showing sampling point locations, transects, important features, etc.

Hydrophytic Vegetation Present? Yes <input checked="" type="checkbox"/> No <input type="checkbox"/> Hydric Soil Present? Yes <input checked="" type="checkbox"/> No <input type="checkbox"/> Wetland Hydrology Present? Yes <input checked="" type="checkbox"/> No <input type="checkbox"/>	Is the Sampled Area within a Wetland? Yes <input checked="" type="checkbox"/> No <input type="checkbox"/>
---	---

Remarks:

Sampling point is located within a herbaceous area of low topography.

VEGETATION – Use scientific names of plants.

Tree Stratum (Plot size: <u>30 feet radius</u>)	Absolute % Cover	Dominant Species?	Indicator Status	Dominance Test worksheet:
1. <u>N/A</u>				Number of Dominant Species That Are OBL, FACW, or FAC: <u>2</u> (A)
2. _____				Total Number of Dominant Species Across All Strata: <u>2</u> (B)
3. _____				Percent of Dominant Species That Are OBL, FACW, or FAC: <u>100%</u> (A/B)
4. _____				Prevalence Index worksheet: Total % Cover of: Multiply by: OBL species <u>N/A</u> x 1 = _____ FACW species _____ x 2 = _____ FAC species _____ x 3 = _____ FACU species _____ x 4 = _____ UPL species _____ x 5 = _____ Column Totals: _____ (A) _____ (B) Prevalence Index = B/A = _____
5. _____				
_____ = Total Cover				
Sapling/Shrub Stratum (Plot size: <u>15 feet radius</u>)	Absolute % Cover	Dominant Species?	Indicator Status	
1. <u>N/A</u>				
2. _____				
3. _____				
4. _____				
5. _____				
_____ = Total Cover				
Herb Stratum (Plot size: <u>5 feet radius</u>)	Absolute % Cover	Dominant Species?	Indicator Status	
1. <u>Paspalum fasciculatum</u>	<u>50%</u>	<u>No</u>	<u>FACW</u>	
2. <u>Ipomoea indica</u>	<u>50%</u>	<u>Yes</u>	<u>FAC</u>	
3. _____				
4. _____				
5. _____				
6. _____				
7. _____				
8. _____				
<u>100%</u> = Total Cover				
Woody Vine Stratum (Plot size: <u>30 feet radius</u>)	Absolute % Cover	Dominant Species?	Indicator Status	
1. <u>N/A</u>				
2. _____				
3. _____				
4. _____				
_____ = Total Cover				

Hydrophytic Vegetation Indicators:
 Rapid Test for Hydrophytic Vegetation
 Dominance Test is >50%
 Prevalence Index is ≤3.0¹
 Problematic Hydrophytic Vegetation¹ (Explain)

¹Indicators of hydric soil and wetland hydrology must be present, unless disturbed or problematic.

Hydrophytic Vegetation Present? Yes No

Remarks:

The 2016 Wetland Plant List was used to determine indicator status.

SOIL

Sampling Point: EC-3

Profile Description: (Describe to the depth needed to document the indicator or confirm the absence of indicators.)

Depth (inches)	Matrix		Redox Features				Texture	Remarks
	Color (moist)	%	Color (moist)	%	Type ¹	Loc ²		
0-6	10YR 2/1	100%					Clay	

¹Type: C=Concentration, D=Depletion, RM=Reduced Matrix, CS=Covered or Coated Sand Grains. ²Location: PL=Pore Lining, M=Matrix.

Hydric Soil Indicators: <input type="checkbox"/> Histosol (A1) <input type="checkbox"/> Histic Epipedon (A2) <input type="checkbox"/> Black Histic (A3) <input checked="" type="checkbox"/> Hydrogen Sulfide (A4) <input type="checkbox"/> Organic Bodies (A6) <input type="checkbox"/> 5 cm Mucky Mineral (A7) <input type="checkbox"/> Muck Presence (A8) <input type="checkbox"/> Depleted Below Dark Surface (A11) <input type="checkbox"/> Thick Dark Surface (A12)		<input type="checkbox"/> Sandy Gleyed Matrix (S4) <input type="checkbox"/> Sandy Redox (S5) <input type="checkbox"/> Stripped Matrix (S6) <input type="checkbox"/> Dark Surface (S7) <input type="checkbox"/> Loamy Gleyed Matrix (F2) <input type="checkbox"/> Depleted Matrix (F3) <input type="checkbox"/> Redox Dark Surface (F6) <input type="checkbox"/> Depleted Dark Surface (F7) <input type="checkbox"/> Redox Depressions (F8)		Indicators for Problematic Hydric Soils³: <input type="checkbox"/> Stratified Layers (A5) <input type="checkbox"/> Very Shallow Dark Surface (TF12) <input type="checkbox"/> Other (Explain in Remarks)
--	--	---	--	--

³Indicators of hydrophytic vegetation and wetland hydrology must be present, unless disturbed or problematic.

Restrictive Layer (if observed): Type: <u>N/A</u> Depth (inches): <u>N/A</u>	Hydric Soil Present? Yes <input checked="" type="checkbox"/> No <input type="checkbox"/>
---	---

Remarks:

High organic content.

HYDROLOGY

Wetland Hydrology Indicators: <u>Primary Indicators (minimum of one required; check all that apply)</u> <input type="checkbox"/> Surface Water (A1) <input checked="" type="checkbox"/> High Water Table (A2) <input checked="" type="checkbox"/> Saturation (A3) <input type="checkbox"/> Water Marks (B1) <input type="checkbox"/> Sediment Deposits (B2) <input type="checkbox"/> Drift Deposits (B3) <input type="checkbox"/> Algal Mat or Crust (B4) <input type="checkbox"/> Iron Deposits (B5) <input type="checkbox"/> Inundation Visible on Aerial Imagery (B7)		<input type="checkbox"/> Water-Stained Leaves (B9) <input type="checkbox"/> Aquatic Fauna (B13) <input checked="" type="checkbox"/> Hydrogen Sulfide Odor (C1) <input type="checkbox"/> Oxidized Rhizospheres on Living Roots (C3) <input type="checkbox"/> Presence of Reduced Iron (C4) <input type="checkbox"/> Recent Iron Reduction in Tilled Soils (C6) <input type="checkbox"/> Thin Muck Surface (C7) <input type="checkbox"/> Fiddler Crab Burrows (C10) <input type="checkbox"/> Other (Explain in Remarks)		<u>Secondary Indicators (minimum of two required)</u> <input type="checkbox"/> Surface Soil Cracks (B6) <input type="checkbox"/> Sparsely Vegetated Concave Surface (B8) <input type="checkbox"/> Drainage Patterns (B10) <input type="checkbox"/> Dry-Season Water Table (C2) <input type="checkbox"/> Saturation Visible on Aerial Imagery (C9) <input type="checkbox"/> Geomorphic Position (D2) <input type="checkbox"/> Shallow Aquitard (D3) <input checked="" type="checkbox"/> FAC-Neutral Test (D5)
---	--	---	--	--

Field Observations: Surface Water Present? Yes <input type="checkbox"/> No <input checked="" type="checkbox"/> Depth (inches): _____ Water Table Present? Yes <input checked="" type="checkbox"/> No <input type="checkbox"/> Depth (inches): <u>2</u> Saturation Present? Yes <input checked="" type="checkbox"/> No <input type="checkbox"/> Depth (inches): <u>1</u> (includes capillary fringe)	Wetland Hydrology Present? Yes <input checked="" type="checkbox"/> No <input type="checkbox"/>
---	---

Describe Recorded Data (stream gauge, monitoring well, aerial photos, previous inspections), if available:

Remarks:
Strong wetland hydrology indicators were found at this sampling point.

WETLAND DETERMINATION DATA FORM – Caribbean Islands Region

Project/Site: Supermercados Econo New Warehouse and Distribution Center Municipality/Town: Canóvanas Sampling Date: September 7, 2016
 Applicant/Owner: Supermercados Econo, Inc. PR or USVI: PR Sampling Point: EC-4
 Investigator(s): Jorge L. Coll Rivera Ward/Estate: Pueblo
 Landform (hillslope, terrace, etc.): Terrace Local relief (concave, convex, none): none Slope (%): 0%
 Lat: 255,945.111 Long: 259,940.186 Datum: State Plane, NAD 83
 Soil Map Unit Name: Mabi clay (MaB) NWI classification: UPL

Are climatic / hydrologic conditions on the site typical for this time of year? Yes No (If no, explain in Remarks.)
 Are Vegetation , Soil , or Hydrology significantly disturbed? Are "Normal Circumstances" present? Yes No
 Are Vegetation , Soil , or Hydrology naturally problematic? (If needed, explain any answers in Remarks.)

SUMMARY OF FINDINGS – Attach site map showing sampling point locations, transects, important features, etc.

Hydrophytic Vegetation Present? Yes <input checked="" type="checkbox"/> No <input type="checkbox"/> Hydric Soil Present? Yes <input checked="" type="checkbox"/> No <input type="checkbox"/> Wetland Hydrology Present? Yes <input checked="" type="checkbox"/> No <input type="checkbox"/>	Is the Sampled Area within a Wetland? Yes <input checked="" type="checkbox"/> No <input type="checkbox"/>
---	---

Remarks:

Sampling point is located within a herbaceous area of low topography.

VEGETATION – Use scientific names of plants.

Tree Stratum (Plot size: <u>30 feet radius</u>)	Absolute % Cover	Dominant Species?	Indicator Status	Dominance Test worksheet:
1. <u>N/A</u>				Number of Dominant Species That Are OBL, FACW, or FAC: <u>2</u> (A)
2. _____				Total Number of Dominant Species Across All Strata: <u>2</u> (B)
3. _____				Percent of Dominant Species That Are OBL, FACW, or FAC: <u>100%</u> (A/B)
4. _____				
5. _____				
_____ = Total Cover				
Sapling/Shrub Stratum (Plot size: <u>15 feet radius</u>)				Prevalence Index worksheet:
1. <u>N/A</u>				Total % Cover of: _____ Multiply by: _____
2. _____				OBL species <u>N/A</u> x 1 = _____
3. _____				FACW species _____ x 2 = _____
4. _____				FAC species _____ x 3 = _____
5. _____				FACU species _____ x 4 = _____
				UPL species _____ x 5 = _____
_____ = Total Cover				Column Totals: _____ (A) _____ (B)
_____ = Total Cover				Prevalence Index = B/A = _____
Herb Stratum (Plot size: <u>5 feet radius</u>)				Hydrophytic Vegetation Indicators:
1. <u>Paspalum fasciculatum</u>	<u>50%</u>	<u>Yes</u>	<u>FACW</u>	<input checked="" type="checkbox"/> Rapid Test for Hydrophytic Vegetation
2. <u>Typha domingensis</u>	<u>15%</u>	<u>No</u>	<u>FACW</u>	<input checked="" type="checkbox"/> Dominance Test is >50%
3. <u>Ipomoea indica</u>	<u>35%</u>	<u>Yes</u>	<u>FAC</u>	<input type="checkbox"/> Prevalence Index is ≤3.0 ¹
4. _____				<input type="checkbox"/> Problematic Hydrophytic Vegetation ¹ (Explain)
5. _____				
6. _____				
7. _____				
8. _____				
_____ = Total Cover				¹ Indicators of hydric soil and wetland hydrology must be present, unless disturbed or problematic.
Woody Vine Stratum (Plot size: <u>30 feet radius</u>)				
1. <u>N/A</u>				
2. _____				
3. _____				
4. _____				
_____ = Total Cover				Hydrophytic Vegetation Present? Yes <input checked="" type="checkbox"/> No <input type="checkbox"/>

Remarks:

The 2016 Wetland Plant List was used to determine indicator status.

SOIL

Sampling Point: EC-4

Profile Description: (Describe to the depth needed to document the indicator or confirm the absence of indicators.)

Depth (inches)	Matrix		Redox Features				Texture	Remarks
	Color (moist)	%	Color (moist)	%	Type ¹	Loc ²		
0-4	10YR 2/1	100%					Clay	

¹Type: C=Concentration, D=Depletion, RM=Reduced Matrix, CS=Covered or Coated Sand Grains. ²Location: PL=Pore Lining, M=Matrix.

<p>Hydric Soil Indicators:</p> <input type="checkbox"/> Histosol (A1) <input type="checkbox"/> Histic Epipedon (A2) <input type="checkbox"/> Black Histic (A3) <input checked="" type="checkbox"/> Hydrogen Sulfide (A4) <input type="checkbox"/> Organic Bodies (A6) <input type="checkbox"/> 5 cm Mucky Mineral (A7) <input type="checkbox"/> Muck Presence (A8) <input type="checkbox"/> Depleted Below Dark Surface (A11) <input type="checkbox"/> Thick Dark Surface (A12)	<input type="checkbox"/> Sandy Gleyed Matrix (S4) <input type="checkbox"/> Sandy Redox (S5) <input type="checkbox"/> Stripped Matrix (S6) <input type="checkbox"/> Dark Surface (S7) <input type="checkbox"/> Loamy Gleyed Matrix (F2) <input type="checkbox"/> Depleted Matrix (F3) <input type="checkbox"/> Redox Dark Surface (F6) <input type="checkbox"/> Depleted Dark Surface (F7) <input type="checkbox"/> Redox Depressions (F8)	<p>Indicators for Problematic Hydric Soils³:</p> <input type="checkbox"/> Stratified Layers (A5) <input type="checkbox"/> Very Shallow Dark Surface (TF12) <input type="checkbox"/> Other (Explain in Remarks)
--	---	--

³Indicators of hydrophytic vegetation and wetland hydrology must be present, unless disturbed or problematic.

<p>Restrictive Layer (if observed): Type: <u>N/A</u> Depth (inches): <u>N/A</u></p>	<p>Hydric Soil Present? Yes <input checked="" type="checkbox"/> No <input type="checkbox"/></p>
--	---

Remarks:
High organic content.

HYDROLOGY

<p>Wetland Hydrology Indicators:</p> <p><u>Primary Indicators (minimum of one required; check all that apply)</u></p> <input checked="" type="checkbox"/> Surface Water (A1) <input checked="" type="checkbox"/> High Water Table (A2) <input checked="" type="checkbox"/> Saturation (A3) <input type="checkbox"/> Water Marks (B1) <input type="checkbox"/> Sediment Deposits (B2) <input type="checkbox"/> Drift Deposits (B3) <input type="checkbox"/> Algal Mat or Crust (B4) <input type="checkbox"/> Iron Deposits (B5) <input type="checkbox"/> Inundation Visible on Aerial Imagery (B7)		<p><u>Secondary Indicators (minimum of two required)</u></p> <input type="checkbox"/> Water-Stained Leaves (B9) <input type="checkbox"/> Aquatic Fauna (B13) <input checked="" type="checkbox"/> Hydrogen Sulfide Odor (C1) <input type="checkbox"/> Oxidized Rhizospheres on Living Roots (C3) <input type="checkbox"/> Presence of Reduced Iron (C4) <input type="checkbox"/> Recent Iron Reduction in Tilled Soils (C6) <input type="checkbox"/> Thin Muck Surface (C7) <input type="checkbox"/> Fiddler Crab Burrows (C10) <input type="checkbox"/> Other (Explain in Remarks)	<input type="checkbox"/> Surface Soil Cracks (B6) <input type="checkbox"/> Sparsely Vegetated Concave Surface (B8) <input type="checkbox"/> Drainage Patterns (B10) <input type="checkbox"/> Dry-Season Water Table (C2) <input type="checkbox"/> Saturation Visible on Aerial Imagery (C9) <input checked="" type="checkbox"/> Geomorphic Position (D2) <input type="checkbox"/> Shallow Aquitard (D3) <input checked="" type="checkbox"/> FAC-Neutral Test (D5)
--	--	--	--

<p>Field Observations:</p> Surface Water Present? Yes <input checked="" type="checkbox"/> No <input type="checkbox"/> Depth (inches): <u>2</u> Water Table Present? Yes <input checked="" type="checkbox"/> No <input type="checkbox"/> Depth (inches): <u>to surface</u> Saturation Present? (includes capillary fringe) Yes <input checked="" type="checkbox"/> No <input type="checkbox"/> Depth (inches): <u>to surface</u>	<p>Wetland Hydrology Present? Yes <input checked="" type="checkbox"/> No <input type="checkbox"/></p>
--	---

Describe Recorded Data (stream gauge, monitoring well, aerial photos, previous inspections), if available:

Remarks:
Strong wetland hydrology indicators were found at this sampling point.

WETLAND DETERMINATION DATA FORM – Caribbean Islands Region

Project/Site: Supermercados Econo New Warehouse and Distribution Center Municipality/Town: Canóvanas Sampling Date: September 7, 2016
 Applicant/Owner: Supermercados Econo, Inc. PR or USVI: PR Sampling Point: EC-5
 Investigator(s): Jorge L. Coll Rivera Ward/Estate: Pueblo
 Landform (hillslope, terrace, etc.): Terrace Local relief (concave, convex, none): none Slope (%): 1-3%
 Lat: 255,961.189 Long: 259,838.356 Datum: State Plane, NAD 83
 Soil Map Unit Name: Mabi clay (MaB) NWI classification: UPL

Are climatic / hydrologic conditions on the site typical for this time of year? Yes No (If no, explain in Remarks.)
 Are Vegetation , Soil , or Hydrology significantly disturbed? Are "Normal Circumstances" present? Yes No
 Are Vegetation , Soil , or Hydrology naturally problematic? (If needed, explain any answers in Remarks.)

SUMMARY OF FINDINGS – Attach site map showing sampling point locations, transects, important features, etc.

Hydrophytic Vegetation Present? Yes <input checked="" type="checkbox"/> No <input type="checkbox"/> Hydric Soil Present? Yes <input checked="" type="checkbox"/> No <input type="checkbox"/> Wetland Hydrology Present? Yes <input checked="" type="checkbox"/> No <input type="checkbox"/>	Is the Sampled Area within a Wetland? Yes <input checked="" type="checkbox"/> No <input type="checkbox"/>
---	---

Remarks:

Sampling point is located within a herbaceous area of low topography.

VEGETATION – Use scientific names of plants.

Tree Stratum (Plot size: <u>30 feet radius</u>)	Absolute % Cover	Dominant Species?	Indicator Status	Dominance Test worksheet:
1. <u>N/A</u>				Number of Dominant Species That Are OBL, FACW, or FAC: <u>2</u> (A)
2. _____				Total Number of Dominant Species Across All Strata: <u>2</u> (B)
3. _____				Percent of Dominant Species That Are OBL, FACW, or FAC: <u>100%</u> (A/B)
4. _____				
5. _____				
_____ = Total Cover				
Sapling/Shrub Stratum (Plot size: <u>15 feet radius</u>)				Prevalence Index worksheet:
1. <u>N/A</u>				Total % Cover of: _____ Multiply by: _____
2. _____				OBL species <u>N/A</u> x 1 = _____
3. _____				FACW species _____ x 2 = _____
4. _____				FAC species _____ x 3 = _____
5. _____				FACU species _____ x 4 = _____
				UPL species _____ x 5 = _____
_____ = Total Cover				Column Totals: _____ (A) _____ (B)
				Prevalence Index = B/A = _____
Herb Stratum (Plot size: <u>5 feet radius</u>)				Hydrophytic Vegetation Indicators:
1. <u>Paspalum fasciculatum</u>	<u>70%</u>	<u>Yes</u>	<u>FACW</u>	<input type="checkbox"/> Rapid Test for Hydrophytic Vegetation
2. <u>Ipomoea indica</u>	<u>20%</u>	<u>Yes</u>	<u>FAC</u>	<input checked="" type="checkbox"/> Dominance Test is >50%
3. _____				<input type="checkbox"/> Prevalence Index is ≤3.0 ¹
4. _____				<input type="checkbox"/> Problematic Hydrophytic Vegetation ¹ (Explain)
5. _____				
6. _____				
7. _____				
8. _____				
_____ = Total Cover				¹ Indicators of hydric soil and wetland hydrology must be present, unless disturbed or problematic.
Woody Vine Stratum (Plot size: <u>30 feet radius</u>)				Hydrophytic Vegetation Present?
1. <u>N/A</u>				Yes <input checked="" type="checkbox"/> No <input type="checkbox"/>
2. _____				
3. _____				
4. _____				
_____ = Total Cover				

Remarks:

The 2016 Wetland Plant List was used to determine indicator status.

SOIL

Sampling Point: EC-5

Profile Description: (Describe to the depth needed to document the indicator or confirm the absence of indicators.)

Depth (inches)	Matrix		Redox Features				Texture	Remarks
	Color (moist)	%	Color (moist)	%	Type ¹	Loc ²		
0-12	10YR 3/1	100%					Clay	

¹Type: C=Concentration, D=Depletion, RM=Reduced Matrix, CS=Covered or Coated Sand Grains. ²Location: PL=Pore Lining, M=Matrix.

Hydric Soil Indicators:

- Histosol (A1)
- Histic Epipedon (A2)
- Black Histic (A3)
- Hydrogen Sulfide (A4)
- Organic Bodies (A6)
- 5 cm Mucky Mineral (A7)
- Muck Presence (A8)
- Depleted Below Dark Surface (A11)
- Thick Dark Surface (A12)
- Sandy Gleyed Matrix (S4)
- Sandy Redox (S5)
- Stripped Matrix (S6)
- Dark Surface (S7)
- Loamy Gleyed Matrix (F2)
- Depleted Matrix (F3)
- Redox Dark Surface (F6)
- Depleted Dark Surface (F7)
- Redox Depressions (F8)

Indicators for Problematic Hydric Soils³:

- Stratified Layers (A5)
- Very Shallow Dark Surface (TF12)
- Other (Explain in Remarks)

³Indicators of hydrophytic vegetation and wetland hydrology must be present, unless disturbed or problematic.

Restrictive Layer (if observed):

Type: N/A
 Depth (inches): N/A

Hydric Soil Present? Yes No

Remarks:

High organic content.

HYDROLOGY

Wetland Hydrology Indicators:

Primary Indicators (minimum of one required; check all that apply)

- Surface Water (A1)
- High Water Table (A2)
- Saturation (A3)
- Water Marks (B1)
- Sediment Deposits (B2)
- Drift Deposits (B3)
- Algal Mat or Crust (B4)
- Iron Deposits (B5)
- Inundation Visible on Aerial Imagery (B7)
- Water-Stained Leaves (B9)
- Aquatic Fauna (B13)
- Hydrogen Sulfide Odor (C1)
- Oxidized Rhizospheres on Living Roots (C3)
- Presence of Reduced Iron (C4)
- Recent Iron Reduction in Tilled Soils (C6)
- Thin Muck Surface (C7)
- Fiddler Crab Burrows (C10)
- Other (Explain in Remarks)

Secondary Indicators (minimum of two required)

- Surface Soil Cracks (B6)
- Sparsely Vegetated Concave Surface (B8)
- Drainage Patterns (B10)
- Dry-Season Water Table (C2)
- Saturation Visible on Aerial Imagery (C9)
- Geomorphic Position (D2)
- Shallow Aquitard (D3)
- FAC-Neutral Test (D5)

Field Observations:

Surface Water Present? Yes No Depth (inches): _____
 Water Table Present? Yes No Depth (inches): 5
 Saturation Present? (includes capillary fringe) Yes No Depth (inches): 3

Wetland Hydrology Present? Yes No

Describe Recorded Data (stream gauge, monitoring well, aerial photos, previous inspections), if available:

Remarks:

Strong wetland hydrology indicators were found at this sampling point.

WETLAND DETERMINATION DATA FORM – Caribbean Islands Region

Project/Site: Supermercados Econo New Warehouse and Distribution Center Municipality/Town: Canóvanas Sampling Date: September 7, 2016
 Applicant/Owner: Supermercados Econo, Inc. PR or USVI: PR Sampling Point: EC-6
 Investigator(s): Jorge L. Coll Rivera Ward/Estate: Pueblo
 Landform (hillslope, terrace, etc.): Terrace Local relief (concave, convex, none): none Slope (%): 1-3%
 Lat: 256,025.502 Long: 259,942.100 Datum: State Plane, NAD 83
 Soil Map Unit Name: Mabi clay (MaB) NWI classification: PEM1C

Are climatic / hydrologic conditions on the site typical for this time of year? Yes No (If no, explain in Remarks.)
 Are Vegetation , Soil , or Hydrology significantly disturbed? Are "Normal Circumstances" present? Yes No
 Are Vegetation , Soil , or Hydrology naturally problematic? (If needed, explain any answers in Remarks.)

SUMMARY OF FINDINGS – Attach site map showing sampling point locations, transects, important features, etc.

Hydrophytic Vegetation Present? Yes <input checked="" type="checkbox"/> No <input type="checkbox"/> Hydric Soil Present? Yes <input checked="" type="checkbox"/> No <input type="checkbox"/> Wetland Hydrology Present? Yes <input checked="" type="checkbox"/> No <input type="checkbox"/>	Is the Sampled Area within a Wetland? Yes <input checked="" type="checkbox"/> No <input type="checkbox"/>
---	---

Remarks:

Sampling point is located within a herbaceous area of low topography.

VEGETATION – Use scientific names of plants.

Tree Stratum (Plot size: <u>30 feet radius</u>)	Absolute % Cover	Dominant Species?	Indicator Status	Dominance Test worksheet:
1. <u>N/A</u>				Number of Dominant Species That Are OBL, FACW, or FAC: <u>1</u> (A)
2. _____				Total Number of Dominant Species Across All Strata: <u>1</u> (B)
3. _____				Percent of Dominant Species That Are OBL, FACW, or FAC: <u>100%</u> (A/B)
4. _____				
5. _____				
_____ = Total Cover				
Sapling/Shrub Stratum (Plot size: <u>15 feet radius</u>)				Prevalence Index worksheet:
1. <u>N/A</u>				Total % Cover of: _____ Multiply by: _____
2. _____				OBL species <u>N/A</u> x 1 = _____
3. _____				FACW species _____ x 2 = _____
4. _____				FAC species _____ x 3 = _____
5. _____				FACU species _____ x 4 = _____
				UPL species _____ x 5 = _____
_____ = Total Cover				Column Totals: _____ (A) _____ (B)
_____ = Total Cover				Prevalence Index = B/A = _____
Herb Stratum (Plot size: <u>5 feet radius</u>)				Hydrophytic Vegetation Indicators:
1. <u>Paspalum fasciculatum</u>	<u>85%</u>	<u>Yes</u>	<u>FACW</u>	<input type="checkbox"/> Rapid Test for Hydrophytic Vegetation
2. <u>Ipomoea indica</u>	<u>5%</u>	<u>No</u>	<u>FAC</u>	<input checked="" type="checkbox"/> Dominance Test is >50%
3. <u>Vigna luteola</u>	<u>10%</u>	<u>No</u>	<u>FAC</u>	<input type="checkbox"/> Prevalence Index is ≤3.0 ¹
4. _____				<input type="checkbox"/> Problematic Hydrophytic Vegetation ¹ (Explain)
5. _____				
6. _____				
7. _____				
8. _____				
_____ = Total Cover				¹ Indicators of hydric soil and wetland hydrology must be present, unless disturbed or problematic.
_____ = Total Cover				
Woody Vine Stratum (Plot size: <u>30 feet radius</u>)				Hydrophytic Vegetation Present? Yes <input checked="" type="checkbox"/> No <input type="checkbox"/>
1. <u>N/A</u>				
2. _____				
3. _____				
4. _____				
_____ = Total Cover				

Remarks:

The 2016 Wetland Plant List was used to determine indicator status.

SOIL

Sampling Point: EC-6

Profile Description: (Describe to the depth needed to document the indicator or confirm the absence of indicators.)

Depth (inches)	Matrix		Redox Features				Texture	Remarks
	Color (moist)	%	Color (moist)	%	Type ¹	Loc ²		
0-12	10YR 3/1	100%					Clay	

¹Type: C=Concentration, D=Depletion, RM=Reduced Matrix, CS=Covered or Coated Sand Grains. ²Location: PL=Pore Lining, M=Matrix.

Hydric Soil Indicators:

- | | |
|--|---|
| <input type="checkbox"/> Histosol (A1) | <input type="checkbox"/> Sandy Gleyed Matrix (S4) |
| <input type="checkbox"/> Histic Epipedon (A2) | <input type="checkbox"/> Sandy Redox (S5) |
| <input type="checkbox"/> Black Histic (A3) | <input type="checkbox"/> Stripped Matrix (S6) |
| <input checked="" type="checkbox"/> Hydrogen Sulfide (A4) | <input type="checkbox"/> Dark Surface (S7) |
| <input type="checkbox"/> Organic Bodies (A6) | <input type="checkbox"/> Loamy Gleyed Matrix (F2) |
| <input type="checkbox"/> 5 cm Mucky Mineral (A7) | <input type="checkbox"/> Depleted Matrix (F3) |
| <input type="checkbox"/> Muck Presence (A8) | <input type="checkbox"/> Redox Dark Surface (F6) |
| <input type="checkbox"/> Depleted Below Dark Surface (A11) | <input type="checkbox"/> Depleted Dark Surface (F7) |
| <input type="checkbox"/> Thick Dark Surface (A12) | <input type="checkbox"/> Redox Depressions (F8) |

Indicators for Problematic Hydric Soils³:

- Stratified Layers (A5)
 Very Shallow Dark Surface (TF12)
 Other (Explain in Remarks)

³Indicators of hydrophytic vegetation and wetland hydrology must be present, unless disturbed or problematic.

Restrictive Layer (if observed):

Type: N/A
 Depth (inches): N/A

Hydric Soil Present? Yes No

Remarks:

High organic content.

HYDROLOGY

Wetland Hydrology Indicators:

Primary Indicators (minimum of one required; check all that apply)

- | | |
|--|---|
| <input type="checkbox"/> Surface Water (A1) | <input type="checkbox"/> Water-Stained Leaves (B9) |
| <input checked="" type="checkbox"/> High Water Table (A2) | <input type="checkbox"/> Aquatic Fauna (B13) |
| <input checked="" type="checkbox"/> Saturation (A3) | <input checked="" type="checkbox"/> Hydrogen Sulfide Odor (C1) |
| <input type="checkbox"/> Water Marks (B1) | <input type="checkbox"/> Oxidized Rhizospheres on Living Roots (C3) |
| <input type="checkbox"/> Sediment Deposits (B2) | <input type="checkbox"/> Presence of Reduced Iron (C4) |
| <input type="checkbox"/> Drift Deposits (B3) | <input type="checkbox"/> Recent Iron Reduction in Tilled Soils (C6) |
| <input type="checkbox"/> Algal Mat or Crust (B4) | <input type="checkbox"/> Thin Muck Surface (C7) |
| <input type="checkbox"/> Iron Deposits (B5) | <input type="checkbox"/> Fiddler Crab Burrows (C10) |
| <input type="checkbox"/> Inundation Visible on Aerial Imagery (B7) | <input type="checkbox"/> Other (Explain in Remarks) |

Secondary Indicators (minimum of two required)

- Surface Soil Cracks (B6)
 Sparsely Vegetated Concave Surface (B8)
 Drainage Patterns (B10)
 Dry-Season Water Table (C2)
 Saturation Visible on Aerial Imagery (C9)
 Geomorphic Position (D2)
 Shallow Aquitard (D3)
 FAC-Neutral Test (D5)

Field Observations:

Surface Water Present? Yes No Depth (inches): _____
 Water Table Present? Yes No Depth (inches): 8
 Saturation Present? (includes capillary fringe) Yes No Depth (inches): 5

Wetland Hydrology Present? Yes No

Describe Recorded Data (stream gauge, monitoring well, aerial photos, previous inspections), if available:

Remarks:

Strong wetland hydrology indicators were found at this sampling point.

WETLAND DETERMINATION DATA FORM – Caribbean Islands Region

Project/Site: Supermercados Econo New Warehouse and Distribution Center Municipality/Town: Canóvanas Sampling Date: September 7, 2016
 Applicant/Owner: Supermercados Econo, Inc. PR or USVI: PR Sampling Point: EC-7
 Investigator(s): Jorge L. Coll Rivera Ward/Estate: Pueblo
 Landform (hillslope, terrace, etc.): Terrace Local relief (concave, convex, none): none Slope (%): 1-3%
 Lat: 256,036.987 Long: 259,938.654 Datum: State Plane, NAD 83
 Soil Map Unit Name: Mabi clay (MaB) NWI classification: PEM1C

Are climatic / hydrologic conditions on the site typical for this time of year? Yes No (If no, explain in Remarks.)
 Are Vegetation , Soil , or Hydrology significantly disturbed? Are "Normal Circumstances" present? Yes No
 Are Vegetation , Soil , or Hydrology naturally problematic? (If needed, explain any answers in Remarks.)

SUMMARY OF FINDINGS – Attach site map showing sampling point locations, transects, important features, etc.

Hydrophytic Vegetation Present? Yes <input checked="" type="checkbox"/> No <input type="checkbox"/> Hydric Soil Present? Yes <input type="checkbox"/> No <input checked="" type="checkbox"/> Wetland Hydrology Present? Yes <input type="checkbox"/> No <input checked="" type="checkbox"/>	Is the Sampled Area within a Wetland? Yes <input type="checkbox"/> No <input checked="" type="checkbox"/>
---	---

Remarks:

Sampling point is located within a topographically higher area.

VEGETATION – Use scientific names of plants.

Tree Stratum (Plot size: <u>30 feet radius</u>)	Absolute % Cover	Dominant Species?	Indicator Status	Dominance Test worksheet:
1. <u>N/A</u>				Number of Dominant Species That Are OBL, FACW, or FAC: <u>2</u> (A)
2. _____				Total Number of Dominant Species Across All Strata: <u>2</u> (B)
3. _____				Percent of Dominant Species That Are OBL, FACW, or FAC: <u>100%</u> (A/B)
4. _____				
5. _____				
_____ = Total Cover				
Sapling/Shrub Stratum (Plot size: <u>15 feet radius</u>)				Prevalence Index worksheet:
1. <u>N/A</u>				Total % Cover of: _____ Multiply by: _____
2. _____				OBL species <u>N/A</u> x 1 = _____
3. _____				FACW species _____ x 2 = _____
4. _____				FAC species _____ x 3 = _____
5. _____				FACU species _____ x 4 = _____
				UPL species _____ x 5 = _____
_____ = Total Cover				Column Totals: _____ (A) _____ (B)
				Prevalence Index = B/A = _____
Herb Stratum (Plot size: <u>5 feet radius</u>)				Hydrophytic Vegetation Indicators:
1. <u>Paspalum fasciculatum</u>	<u>90%</u>	<u>Yes</u>	<u>FACW</u>	<input type="checkbox"/> Rapid Test for Hydrophytic Vegetation
2. <u>Megathyrsus maximus</u>	<u>10%</u>	<u>No</u>	<u>FACU</u>	<input checked="" type="checkbox"/> Dominance Test is >50%
3. <u>Vigna luteola</u>	<u>50%</u>	<u>Yes</u>	<u>FAC</u>	<input type="checkbox"/> Prevalence Index is ≤3.0 ¹
4. _____				<input type="checkbox"/> Problematic Hydrophytic Vegetation ¹ (Explain)
5. _____				
6. _____				
7. _____				
8. _____				
_____ = Total Cover				
Woody Vine Stratum (Plot size: <u>30 feet radius</u>)				
1. <u>N/A</u>				
2. _____				
3. _____				
4. _____				
_____ = Total Cover				

¹Indicators of hydric soil and wetland hydrology must be present, unless disturbed or problematic.

Hydrophytic Vegetation Present? Yes No

Remarks:

The 2016 Wetland Plant List was used to determine indicator status.

SOIL

Sampling Point: EC-7

Profile Description: (Describe to the depth needed to document the indicator or confirm the absence of indicators.)

Depth (inches)	Matrix		Redox Features				Texture	Remarks
	Color (moist)	%	Color (moist)	%	Type ¹	Loc ²		
0-12	10YR 4/3	100%					Clay	Some fill material

¹Type: C=Concentration, D=Depletion, RM=Reduced Matrix, CS=Covered or Coated Sand Grains. ²Location: PL=Pore Lining, M=Matrix.

Hydric Soil Indicators:

- | | |
|--|---|
| <input type="checkbox"/> Histosol (A1) | <input type="checkbox"/> Sandy Gleyed Matrix (S4) |
| <input type="checkbox"/> Histic Epipedon (A2) | <input type="checkbox"/> Sandy Redox (S5) |
| <input type="checkbox"/> Black Histic (A3) | <input type="checkbox"/> Stripped Matrix (S6) |
| <input type="checkbox"/> Hydrogen Sulfide (A4) | <input type="checkbox"/> Dark Surface (S7) |
| <input type="checkbox"/> Organic Bodies (A6) | <input type="checkbox"/> Loamy Gleyed Matrix (F2) |
| <input type="checkbox"/> 5 cm Mucky Mineral (A7) | <input type="checkbox"/> Depleted Matrix (F3) |
| <input type="checkbox"/> Muck Presence (A8) | <input type="checkbox"/> Redox Dark Surface (F6) |
| <input type="checkbox"/> Depleted Below Dark Surface (A11) | <input type="checkbox"/> Depleted Dark Surface (F7) |
| <input type="checkbox"/> Thick Dark Surface (A12) | <input type="checkbox"/> Redox Depressions (F8) |

Indicators for Problematic Hydric Soils³:

- Stratified Layers (A5)
 Very Shallow Dark Surface (TF12)
 Other (Explain in Remarks)

³Indicators of hydrophytic vegetation and wetland hydrology must be present, unless disturbed or problematic.

Restrictive Layer (if observed):

Type: N/A
 Depth (inches): N/A

Hydric Soil Present? Yes No

Remarks:

No hydric soil indicators were found at this sampling point.

HYDROLOGY

Wetland Hydrology Indicators:

Primary Indicators (minimum of one required; check all that apply)

- | | |
|--|---|
| <input type="checkbox"/> Surface Water (A1) | <input type="checkbox"/> Water-Stained Leaves (B9) |
| <input type="checkbox"/> High Water Table (A2) | <input type="checkbox"/> Aquatic Fauna (B13) |
| <input type="checkbox"/> Saturation (A3) | <input type="checkbox"/> Hydrogen Sulfide Odor (C1) |
| <input type="checkbox"/> Water Marks (B1) | <input type="checkbox"/> Oxidized Rhizospheres on Living Roots (C3) |
| <input type="checkbox"/> Sediment Deposits (B2) | <input type="checkbox"/> Presence of Reduced Iron (C4) |
| <input type="checkbox"/> Drift Deposits (B3) | <input type="checkbox"/> Recent Iron Reduction in Tilled Soils (C6) |
| <input type="checkbox"/> Algal Mat or Crust (B4) | <input type="checkbox"/> Thin Muck Surface (C7) |
| <input type="checkbox"/> Iron Deposits (B5) | <input type="checkbox"/> Fiddler Crab Burrows (C10) |
| <input type="checkbox"/> Inundation Visible on Aerial Imagery (B7) | <input type="checkbox"/> Other (Explain in Remarks) |

Secondary Indicators (minimum of two required)

- Surface Soil Cracks (B6)
 Sparsely Vegetated Concave Surface (B8)
 Drainage Patterns (B10)
 Dry-Season Water Table (C2)
 Saturation Visible on Aerial Imagery (C9)
 Geomorphic Position (D2)
 Shallow Aquitard (D3)
 FAC-Neutral Test (D5)

Field Observations:

Surface Water Present? Yes No Depth (inches): _____
 Water Table Present? Yes No Depth (inches): _____
 Saturation Present? Yes No Depth (inches): _____
 (includes capillary fringe)

Wetland Hydrology Present? Yes No

Describe Recorded Data (stream gauge, monitoring well, aerial photos, previous inspections), if available:

Remarks:

No strong wetland hydrology indicators were found at this sampling point.

WETLAND DETERMINATION DATA FORM – Caribbean Islands Region

Project/Site: Supermercados Econo New Warehouse and Distribution Center Municipality/Town: Canóvanas Sampling Date: September 7, 2016
 Applicant/Owner: Supermercados Econo, Inc. PR or USVI: PR Sampling Point: EC-8
 Investigator(s): Jorge L. Coll Rivera Ward/Estate: Pueblo
 Landform (hillslope, terrace, etc.): Hillslope Local relief (concave, convex, none): none Slope (%): 3-5%
 Lat: 255,631.967 Long: 260,088.336 Datum: State Plane, NAD 83
 Soil Map Unit Name: Mabi clay 5-12% slope (MaC2) NWI classification: PEM1C

Are climatic / hydrologic conditions on the site typical for this time of year? Yes No (If no, explain in Remarks.)
 Are Vegetation , Soil , or Hydrology significantly disturbed? Are "Normal Circumstances" present? Yes No
 Are Vegetation , Soil , or Hydrology naturally problematic? (If needed, explain any answers in Remarks.)

SUMMARY OF FINDINGS – Attach site map showing sampling point locations, transects, important features, etc.

Hydrophytic Vegetation Present? Yes <input checked="" type="checkbox"/> No <input type="checkbox"/> Hydric Soil Present? Yes <input type="checkbox"/> No <input checked="" type="checkbox"/> Wetland Hydrology Present? Yes <input type="checkbox"/> No <input checked="" type="checkbox"/>	Is the Sampled Area within a Wetland? Yes <input type="checkbox"/> No <input checked="" type="checkbox"/>
---	---

Remarks:

Sampling point is located within a topographically higher area.

VEGETATION – Use scientific names of plants.

Tree Stratum (Plot size: <u>30 feet radius</u>)	Absolute % Cover	Dominant Species?	Indicator Status	Dominance Test worksheet:
1. <u>Albizia procera</u>	<u>75%</u>	Yes	UPL	Number of Dominant Species That Are OBL, FACW, or FAC: <u>2</u> (A)
2. _____	_____	_____	_____	Total Number of Dominant Species Across All Strata: <u>3</u> (B)
3. _____	_____	_____	_____	Percent of Dominant Species That Are OBL, FACW, or FAC: <u>67%</u> (A/B)
4. _____	_____	_____	_____	Prevalence Index worksheet: Total % Cover of: _____ Multiply by: _____ OBL species <u>N/A</u> x 1 = _____ FACW species _____ x 2 = _____ FAC species _____ x 3 = _____ FACU species _____ x 4 = _____ UPL species _____ x 5 = _____ Column Totals: _____ (A) _____ (B) Prevalence Index = B/A = _____
5. _____	_____	_____	_____	
<u>75%</u> = Total Cover				
Sapling/Shrub Stratum (Plot size: <u>15 feet radius</u>)				
1. <u>Casearia guianensis</u>	<u>10%</u>	Yes	FAC	
2. _____	_____	_____	_____	
3. _____	_____	_____	_____	
4. _____	_____	_____	_____	
5. _____	_____	_____	_____	
<u>10%</u> = Total Cover				
Herb Stratum (Plot size: <u>5 feet radius</u>)				
1. <u>Paspalum fasciculatum</u>	<u>50%</u>	Yes	FACW	
2. _____	_____	_____	_____	
3. _____	_____	_____	_____	
4. _____	_____	_____	_____	
5. _____	_____	_____	_____	
6. _____	_____	_____	_____	
7. _____	_____	_____	_____	
8. _____	_____	_____	_____	
<u>50%</u> = Total Cover				
Woody Vine Stratum (Plot size: <u>30 feet radius</u>)				
1. <u>N/A</u>	_____	_____	_____	
2. _____	_____	_____	_____	
3. _____	_____	_____	_____	
4. _____	_____	_____	_____	
_____ = Total Cover				

Hydrophytic Vegetation Indicators:
 Rapid Test for Hydrophytic Vegetation
 Dominance Test is >50%
 Prevalence Index is ≤3.0¹
 Problematic Hydrophytic Vegetation¹ (Explain)

¹Indicators of hydric soil and wetland hydrology must be present, unless disturbed or problematic.

Hydrophytic Vegetation Present? Yes No

Remarks:

The 2016 Wetland Plant List was used to determine indicator status.

SOIL

Sampling Point: EC-8

Profile Description: (Describe to the depth needed to document the indicator or confirm the absence of indicators.)

Depth (inches)	Matrix		Redox Features				Texture	Remarks
	Color (moist)	%	Color (moist)	%	Type ¹	Loc ²		
0-4	10YR 4/4	100%					Clay	Rock outcrop

¹Type: C=Concentration, D=Depletion, RM=Reduced Matrix, CS=Covered or Coated Sand Grains. ²Location: PL=Pore Lining, M=Matrix.

Hydric Soil Indicators:

- | | |
|--|---|
| <input type="checkbox"/> Histosol (A1) | <input type="checkbox"/> Sandy Gleyed Matrix (S4) |
| <input type="checkbox"/> Histic Epipedon (A2) | <input type="checkbox"/> Sandy Redox (S5) |
| <input type="checkbox"/> Black Histic (A3) | <input type="checkbox"/> Stripped Matrix (S6) |
| <input type="checkbox"/> Hydrogen Sulfide (A4) | <input type="checkbox"/> Dark Surface (S7) |
| <input type="checkbox"/> Organic Bodies (A6) | <input type="checkbox"/> Loamy Gleyed Matrix (F2) |
| <input type="checkbox"/> 5 cm Mucky Mineral (A7) | <input type="checkbox"/> Depleted Matrix (F3) |
| <input type="checkbox"/> Muck Presence (A8) | <input type="checkbox"/> Redox Dark Surface (F6) |
| <input type="checkbox"/> Depleted Below Dark Surface (A11) | <input type="checkbox"/> Depleted Dark Surface (F7) |
| <input type="checkbox"/> Thick Dark Surface (A12) | <input type="checkbox"/> Redox Depressions (F8) |

Indicators for Problematic Hydric Soils³:

- Stratified Layers (A5)
- Very Shallow Dark Surface (TF12)
- Other (Explain in Remarks)

³Indicators of hydrophytic vegetation and wetland hydrology must be present, unless disturbed or problematic.

Restrictive Layer (if observed):

Type: N/A
 Depth (inches): N/A

Hydric Soil Present? Yes No

Remarks:

No hydric soil indicators were found at this sampling point.

HYDROLOGY

Wetland Hydrology Indicators:

Primary Indicators (minimum of one required; check all that apply)

- | | |
|--|---|
| <input type="checkbox"/> Surface Water (A1) | <input type="checkbox"/> Water-Stained Leaves (B9) |
| <input type="checkbox"/> High Water Table (A2) | <input type="checkbox"/> Aquatic Fauna (B13) |
| <input type="checkbox"/> Saturation (A3) | <input type="checkbox"/> Hydrogen Sulfide Odor (C1) |
| <input type="checkbox"/> Water Marks (B1) | <input type="checkbox"/> Oxidized Rhizospheres on Living Roots (C3) |
| <input type="checkbox"/> Sediment Deposits (B2) | <input type="checkbox"/> Presence of Reduced Iron (C4) |
| <input type="checkbox"/> Drift Deposits (B3) | <input type="checkbox"/> Recent Iron Reduction in Tilled Soils (C6) |
| <input type="checkbox"/> Algal Mat or Crust (B4) | <input type="checkbox"/> Thin Muck Surface (C7) |
| <input type="checkbox"/> Iron Deposits (B5) | <input type="checkbox"/> Fiddler Crab Burrows (C10) |
| <input type="checkbox"/> Inundation Visible on Aerial Imagery (B7) | <input type="checkbox"/> Other (Explain in Remarks) |

Secondary Indicators (minimum of two required)

- Surface Soil Cracks (B6)
- Sparsely Vegetated Concave Surface (B8)
- Drainage Patterns (B10)
- Dry-Season Water Table (C2)
- Saturation Visible on Aerial Imagery (C9)
- Geomorphic Position (D2)
- Shallow Aquitard (D3)
- FAC-Neutral Test (D5)

Field Observations:

Surface Water Present? Yes No Depth (inches): _____
 Water Table Present? Yes No Depth (inches): _____
 Saturation Present? (includes capillary fringe) Yes No Depth (inches): _____

Wetland Hydrology Present? Yes No

Describe Recorded Data (stream gauge, monitoring well, aerial photos, previous inspections), if available:

Remarks:

No wetland hydrology indicators were found at this sampling point.

WETLAND DETERMINATION DATA FORM – Caribbean Islands Region

Project/Site: Supermercados Econo New Warehouse and Distribution Center Municipality/Town: Canóvanas Sampling Date: September 7, 2016
 Applicant/Owner: Supermercados Econo, Inc. PR or USVI: PR Sampling Point: EC-9
 Investigator(s): Jorge L. Coll Rivera Ward/Estate: Pueblo
 Landform (hillslope, terrace, etc.): Hillslope Local relief (concave, convex, none): none Slope (%): 5-10%
 Lat: 255.632.349 Long: 260.113.219 Datum: State Plane, NAD 83
 Soil Map Unit Name: Mabi clay 5-12% slope (MaC2) NWI classification: PEM1C

Are climatic / hydrologic conditions on the site typical for this time of year? Yes No (If no, explain in Remarks.)
 Are Vegetation , Soil , or Hydrology significantly disturbed? Are "Normal Circumstances" present? Yes No
 Are Vegetation , Soil , or Hydrology naturally problematic? (If needed, explain any answers in Remarks.)

SUMMARY OF FINDINGS – Attach site map showing sampling point locations, transects, important features, etc.

Hydrophytic Vegetation Present? Yes <input checked="" type="checkbox"/> No <input type="checkbox"/> Hydric Soil Present? Yes <input type="checkbox"/> No <input checked="" type="checkbox"/> Wetland Hydrology Present? Yes <input type="checkbox"/> No <input checked="" type="checkbox"/>	Is the Sampled Area within a Wetland? Yes <input type="checkbox"/> No <input checked="" type="checkbox"/>
---	---

Remarks:

Sampling point is located within a topographically higher area.

VEGETATION – Use scientific names of plants.

Tree Stratum (Plot size: <u>30 feet radius</u>)	Absolute % Cover	Dominant Species?	Indicator Status	Dominance Test worksheet:																
1. <u>Albizia procera</u>	<u>35%</u>	Yes	UPL	Number of Dominant Species That Are OBL, FACW, or FAC: <u>1</u> (A)																
2. _____	_____	_____	_____	Total Number of Dominant Species Across All Strata: <u>2</u> (B)																
3. _____	_____	_____	_____	Percent of Dominant Species That Are OBL, FACW, or FAC: <u>50%</u> (A/B)																
4. _____	_____	_____	_____	Prevalence Index worksheet: <table style="width:100%; border-collapse: collapse;"> <tr> <td style="width:50%;">Total % Cover of:</td> <td style="width:50%;">Multiply by:</td> </tr> <tr> <td>OBL species <u>0</u></td> <td>x 1 = <u>0</u></td> </tr> <tr> <td>FACW species <u>100</u></td> <td>x 2 = <u>200</u></td> </tr> <tr> <td>FAC species <u>0</u></td> <td>x 3 = <u>0</u></td> </tr> <tr> <td>FACU species <u>0</u></td> <td>x 4 = <u>0</u></td> </tr> <tr> <td>UPL species <u>35</u></td> <td>x 5 = <u>175</u></td> </tr> <tr> <td>Column Totals: <u>135</u> (A)</td> <td><u>375</u> (B)</td> </tr> <tr> <td colspan="2" style="text-align: center;">Prevalence Index = B/A = <u>2.78</u></td> </tr> </table>	Total % Cover of:	Multiply by:	OBL species <u>0</u>	x 1 = <u>0</u>	FACW species <u>100</u>	x 2 = <u>200</u>	FAC species <u>0</u>	x 3 = <u>0</u>	FACU species <u>0</u>	x 4 = <u>0</u>	UPL species <u>35</u>	x 5 = <u>175</u>	Column Totals: <u>135</u> (A)	<u>375</u> (B)	Prevalence Index = B/A = <u>2.78</u>	
Total % Cover of:	Multiply by:																			
OBL species <u>0</u>	x 1 = <u>0</u>																			
FACW species <u>100</u>	x 2 = <u>200</u>																			
FAC species <u>0</u>	x 3 = <u>0</u>																			
FACU species <u>0</u>	x 4 = <u>0</u>																			
UPL species <u>35</u>	x 5 = <u>175</u>																			
Column Totals: <u>135</u> (A)	<u>375</u> (B)																			
Prevalence Index = B/A = <u>2.78</u>																				
5. _____	_____	_____	_____																	
<u>35%</u> = Total Cover																				
Sapling/Shrub Stratum (Plot size: <u>15 feet radius</u>)																				
1. <u>N/A</u>	_____	_____	_____																	
2. _____	_____	_____	_____																	
3. _____	_____	_____	_____																	
4. _____	_____	_____	_____																	
5. _____	_____	_____	_____																	
_____ = Total Cover																				
Herb Stratum (Plot size: <u>5 feet radius</u>)																				
1. <u>Paspalum fasciculatum</u>	<u>100%</u>	Yes	FACW																	
2. _____	_____	_____	_____																	
3. _____	_____	_____	_____																	
4. _____	_____	_____	_____																	
5. _____	_____	_____	_____																	
6. _____	_____	_____	_____																	
7. _____	_____	_____	_____																	
8. _____	_____	_____	_____																	
<u>100%</u> = Total Cover																				
Woody Vine Stratum (Plot size: <u>30 feet radius</u>)																				
1. <u>N/A</u>	_____	_____	_____																	
2. _____	_____	_____	_____																	
3. _____	_____	_____	_____																	
4. _____	_____	_____	_____																	
_____ = Total Cover																				

Hydrophytic Vegetation Indicators:
 Rapid Test for Hydrophytic Vegetation
 Dominance Test is >50%
 Prevalence Index is ≤3.0¹
 Problematic Hydrophytic Vegetation¹ (Explain)

¹Indicators of hydric soil and wetland hydrology must be present, unless disturbed or problematic.

Hydrophytic Vegetation Present? Yes No

Remarks:

The 2016 Wetland Plant List was used to determine indicator status.

SOIL

Sampling Point: EC-9

Profile Description: (Describe to the depth needed to document the indicator or confirm the absence of indicators.)

Depth (inches)	Matrix		Redox Features				Texture	Remarks
	Color (moist)	%	Color (moist)	%	Type ¹	Loc ²		
0-11	10YR 5/6	100%					Clay	
11-13	10YR 5/6	70%					Clay	
	10YR 6/1	30%					Clay	Crushed calcareous mudstone

¹Type: C=Concentration, D=Depletion, RM=Reduced Matrix, CS=Covered or Coated Sand Grains. ²Location: PL=Pore Lining, M=Matrix.

Hydric Soil Indicators:

<input type="checkbox"/> Histosol (A1)	<input type="checkbox"/> Sandy Gleyed Matrix (S4)	Indicators for Problematic Hydric Soils³:
<input type="checkbox"/> Histic Epipedon (A2)	<input type="checkbox"/> Sandy Redox (S5)	
<input type="checkbox"/> Black Histic (A3)	<input type="checkbox"/> Stripped Matrix (S6)	
<input type="checkbox"/> Hydrogen Sulfide (A4)	<input type="checkbox"/> Dark Surface (S7)	
<input type="checkbox"/> Organic Bodies (A6)	<input type="checkbox"/> Loamy Gleyed Matrix (F2)	
<input type="checkbox"/> 5 cm Mucky Mineral (A7)	<input type="checkbox"/> Depleted Matrix (F3)	
<input type="checkbox"/> Muck Presence (A8)	<input type="checkbox"/> Redox Dark Surface (F6)	
<input type="checkbox"/> Depleted Below Dark Surface (A11)	<input type="checkbox"/> Depleted Dark Surface (F7)	
<input type="checkbox"/> Thick Dark Surface (A12)	<input type="checkbox"/> Redox Depressions (F8)	

Stratified Layers (A5)
 Very Shallow Dark Surface (TF12)
 Other (Explain in Remarks)

³Indicators of hydrophytic vegetation and wetland hydrology must be present, unless disturbed or problematic.

Restrictive Layer (if observed):
 Type: N/A
 Depth (inches): N/A

Hydric Soil Present? Yes No

Remarks:
 No hydric soil indicators were found at this sampling point. The crushed calcareous mudstone found is an element from local geology (Friales Formation).

HYDROLOGY

Wetland Hydrology Indicators:

Primary Indicators (minimum of one required; check all that apply)		Secondary Indicators (minimum of two required)
<input type="checkbox"/> Surface Water (A1)	<input type="checkbox"/> Water-Stained Leaves (B9)	<input type="checkbox"/> Surface Soil Cracks (B6)
<input type="checkbox"/> High Water Table (A2)	<input type="checkbox"/> Aquatic Fauna (B13)	<input type="checkbox"/> Sparsely Vegetated Concave Surface (B8)
<input type="checkbox"/> Saturation (A3)	<input type="checkbox"/> Hydrogen Sulfide Odor (C1)	<input type="checkbox"/> Drainage Patterns (B10)
<input type="checkbox"/> Water Marks (B1)	<input type="checkbox"/> Oxidized Rhizospheres on Living Roots (C3)	<input type="checkbox"/> Dry-Season Water Table (C2)
<input type="checkbox"/> Sediment Deposits (B2)	<input type="checkbox"/> Presence of Reduced Iron (C4)	<input type="checkbox"/> Saturation Visible on Aerial Imagery (C9)
<input type="checkbox"/> Drift Deposits (B3)	<input type="checkbox"/> Recent Iron Reduction in Tilled Soils (C6)	<input type="checkbox"/> Geomorphic Position (D2)
<input type="checkbox"/> Algal Mat or Crust (B4)	<input type="checkbox"/> Thin Muck Surface (C7)	<input type="checkbox"/> Shallow Aquitard (D3)
<input type="checkbox"/> Iron Deposits (B5)	<input type="checkbox"/> Fiddler Crab Burrows (C10)	<input checked="" type="checkbox"/> FAC-Neutral Test (D5)
<input type="checkbox"/> Inundation Visible on Aerial Imagery (B7)	<input type="checkbox"/> Other (Explain in Remarks)	

Field Observations:

Surface Water Present? Yes No Depth (inches): _____

Water Table Present? Yes No Depth (inches): _____

Saturation Present? (includes capillary fringe) Yes No Depth (inches): _____

Wetland Hydrology Present? Yes No

Describe Recorded Data (stream gauge, monitoring well, aerial photos, previous inspections), if available:

Remarks:
 No strong wetland hydrology indicators were found at this sampling point.

WETLAND DETERMINATION DATA FORM – Caribbean Islands Region

Project/Site: Supermercados Econo New Warehouse and Distribution Center Municipality/Town: Canóvanas Sampling Date: September 7, 2016
 Applicant/Owner: Supermercados Econo, Inc. PR or USVI: PR Sampling Point: EC-10
 Investigator(s): Jorge L. Coll Rivera Ward/Estate: Pueblo
 Landform (hillslope, terrace, etc.): Hillslope Local relief (concave, convex, none): none Slope (%): 5-10%
 Lat: 255,642.685 Long: 260,131.211 Datum: State Plane, NAD 83
 Soil Map Unit Name: Mabi clay (MaB) NWI classification: PEM1C

Are climatic / hydrologic conditions on the site typical for this time of year? Yes No (If no, explain in Remarks.)
 Are Vegetation , Soil , or Hydrology significantly disturbed? Are "Normal Circumstances" present? Yes No
 Are Vegetation , Soil , or Hydrology naturally problematic? (If needed, explain any answers in Remarks.)

SUMMARY OF FINDINGS – Attach site map showing sampling point locations, transects, important features, etc.

Hydrophytic Vegetation Present? Yes <input checked="" type="checkbox"/> No <input type="checkbox"/> Hydric Soil Present? Yes <input type="checkbox"/> No <input checked="" type="checkbox"/> Wetland Hydrology Present? Yes <input type="checkbox"/> No <input checked="" type="checkbox"/>	Is the Sampled Area within a Wetland? Yes <input type="checkbox"/> No <input checked="" type="checkbox"/>
---	---

Remarks:

Sampling point is located within a topographically higher area.

VEGETATION – Use scientific names of plants.

Tree Stratum (Plot size: <u>30 feet radius</u>)	Absolute % Cover	Dominant Species?	Indicator Status	
1. <u>N/A</u>				Dominance Test worksheet: Number of Dominant Species That Are OBL, FACW, or FAC: <u>1</u> (A) Total Number of Dominant Species Across All Strata: <u>1</u> (B) Percent of Dominant Species That Are OBL, FACW, or FAC: <u>100%</u> (A/B)
2. _____				
3. _____				
4. _____				
5. _____				
_____ = Total Cover				Prevalence Index worksheet: Total % Cover of: _____ Multiply by: OBL species <u>N/A</u> x 1 = _____ FACW species _____ x 2 = _____ FAC species _____ x 3 = _____ FACU species _____ x 4 = _____ UPL species _____ x 5 = _____ Column Totals: _____ (A) _____ (B) Prevalence Index = B/A = _____
Sapling/Shrub Stratum (Plot size: <u>15 feet radius</u>)				
1. <u>N/A</u>				
2. _____				
3. _____				
4. _____				
5. _____				
_____ = Total Cover				
Herb Stratum (Plot size: <u>5 feet radius</u>)				
1. <u>Paspalum fasciculatum</u>	<u>100%</u>	<u>Yes</u>	<u>FACW</u>	Hydrophytic Vegetation Indicators: <input type="checkbox"/> Rapid Test for Hydrophytic Vegetation <input checked="" type="checkbox"/> Dominance Test is >50% <input type="checkbox"/> Prevalence Index is ≤3.0 ¹ <input type="checkbox"/> Problematic Hydrophytic Vegetation ¹ (Explain)
2. <u>Mimosa casta</u>	<u>5%</u>	<u>No</u>	<u>FACW</u>	
3. <u>Vigna luteola</u>	<u>5%</u>	<u>No</u>	<u>FAC</u>	
4. _____				
5. _____				
6. _____				
7. _____				
8. _____				
<u>110%</u> = Total Cover				
Woody Vine Stratum (Plot size: <u>30 feet radius</u>)				
1. <u>N/A</u>				
2. _____				
3. _____				
4. _____				
_____ = Total Cover				

Remarks:

The 2016 Wetland Plant List was used to determine indicator status.

SOIL

Sampling Point: EC-10

Profile Description: (Describe to the depth needed to document the indicator or confirm the absence of indicators.)

Depth (inches)	Matrix		Redox Features				Texture	Remarks
	Color (moist)	%	Color (moist)	%	Type ¹	Loc ²		
0-13	10YR 4/3	100%					Clay	

¹Type: C=Concentration, D=Depletion, RM=Reduced Matrix, CS=Covered or Coated Sand Grains. ²Location: PL=Pore Lining, M=Matrix.

Hydric Soil Indicators:

- | | |
|--|---|
| <input type="checkbox"/> Histosol (A1) | <input type="checkbox"/> Sandy Gleyed Matrix (S4) |
| <input type="checkbox"/> Histic Epipedon (A2) | <input type="checkbox"/> Sandy Redox (S5) |
| <input type="checkbox"/> Black Histic (A3) | <input type="checkbox"/> Stripped Matrix (S6) |
| <input type="checkbox"/> Hydrogen Sulfide (A4) | <input type="checkbox"/> Dark Surface (S7) |
| <input type="checkbox"/> Organic Bodies (A6) | <input type="checkbox"/> Loamy Gleyed Matrix (F2) |
| <input type="checkbox"/> 5 cm Mucky Mineral (A7) | <input type="checkbox"/> Depleted Matrix (F3) |
| <input type="checkbox"/> Muck Presence (A8) | <input type="checkbox"/> Redox Dark Surface (F6) |
| <input type="checkbox"/> Depleted Below Dark Surface (A11) | <input type="checkbox"/> Depleted Dark Surface (F7) |
| <input type="checkbox"/> Thick Dark Surface (A12) | <input type="checkbox"/> Redox Depressions (F8) |

Indicators for Problematic Hydric Soils³:

- Stratified Layers (A5)
- Very Shallow Dark Surface (TF12)
- Other (Explain in Remarks)

³Indicators of hydrophytic vegetation and wetland hydrology must be present, unless disturbed or problematic.

Restrictive Layer (if observed):

Type: N/A
 Depth (inches): N/A

Hydric Soil Present? Yes No

Remarks:

No hydric soil indicators were found at this sampling point.

HYDROLOGY

Wetland Hydrology Indicators:

Primary Indicators (minimum of one required; check all that apply)

- | | |
|--|---|
| <input type="checkbox"/> Surface Water (A1) | <input type="checkbox"/> Water-Stained Leaves (B9) |
| <input type="checkbox"/> High Water Table (A2) | <input type="checkbox"/> Aquatic Fauna (B13) |
| <input type="checkbox"/> Saturation (A3) | <input type="checkbox"/> Hydrogen Sulfide Odor (C1) |
| <input type="checkbox"/> Water Marks (B1) | <input type="checkbox"/> Oxidized Rhizospheres on Living Roots (C3) |
| <input type="checkbox"/> Sediment Deposits (B2) | <input type="checkbox"/> Presence of Reduced Iron (C4) |
| <input type="checkbox"/> Drift Deposits (B3) | <input type="checkbox"/> Recent Iron Reduction in Tilled Soils (C6) |
| <input type="checkbox"/> Algal Mat or Crust (B4) | <input type="checkbox"/> Thin Muck Surface (C7) |
| <input type="checkbox"/> Iron Deposits (B5) | <input type="checkbox"/> Fiddler Crab Burrows (C10) |
| <input type="checkbox"/> Inundation Visible on Aerial Imagery (B7) | <input type="checkbox"/> Other (Explain in Remarks) |

Secondary Indicators (minimum of two required)

- Surface Soil Cracks (B6)
- Sparsely Vegetated Concave Surface (B8)
- Drainage Patterns (B10)
- Dry-Season Water Table (C2)
- Saturation Visible on Aerial Imagery (C9)
- Geomorphic Position (D2)
- Shallow Aquitard (D3)
- FAC-Neutral Test (D5)

Field Observations:

Surface Water Present? Yes No Depth (inches): _____
 Water Table Present? Yes No Depth (inches): _____
 Saturation Present? Yes No Depth (inches): _____
 (includes capillary fringe)

Wetland Hydrology Present? Yes No

Describe Recorded Data (stream gauge, monitoring well, aerial photos, previous inspections), if available:

Remarks:

No strong wetland hydrology indicators were found at this sampling point.

WETLAND DETERMINATION DATA FORM – Caribbean Islands Region

Project/Site: Supermercados Econo New Warehouse and Distribution Center Municipality/Town: Canóvanas Sampling Date: September 7, 2016
 Applicant/Owner: Supermercados Econo, Inc. PR or USVI: PR Sampling Point: EC-11
 Investigator(s): Jorge L. Coll Rivera Ward/Estate: Pueblo
 Landform (hillslope, terrace, etc.): Drainage basin Local relief (concave, convex, none): concave Slope (%): 0%
 Lat: 255,630.435 Long: 260,151.118 Datum: State Plane, NAD 83
 Soil Map Unit Name: Mabi clay (MaB) NWI classification: PEM1C

Are climatic / hydrologic conditions on the site typical for this time of year? Yes No (If no, explain in Remarks.)
 Are Vegetation , Soil , or Hydrology significantly disturbed? Are "Normal Circumstances" present? Yes No
 Are Vegetation , Soil , or Hydrology naturally problematic? (If needed, explain any answers in Remarks.)

SUMMARY OF FINDINGS – Attach site map showing sampling point locations, transects, important features, etc.

Hydrophytic Vegetation Present? Yes <input checked="" type="checkbox"/> No <input type="checkbox"/> Hydric Soil Present? Yes <input checked="" type="checkbox"/> No <input type="checkbox"/> Wetland Hydrology Present? Yes <input checked="" type="checkbox"/> No <input type="checkbox"/>	Is the Sampled Area within a Wetland? Yes <input checked="" type="checkbox"/> No <input type="checkbox"/>
---	---

Remarks:

Sampling point is located within a topographically lower area.

VEGETATION – Use scientific names of plants.

Tree Stratum (Plot size: <u>30 feet radius</u>)	Absolute % Cover	Dominant Species?	Indicator Status	Dominance Test worksheet:
1. <u>N/A</u>				Number of Dominant Species That Are OBL, FACW, or FAC: <u>2</u> (A)
2. _____				Total Number of Dominant Species Across All Strata: <u>2</u> (B)
3. _____				Percent of Dominant Species That Are OBL, FACW, or FAC: <u>100%</u> (A/B)
4. _____				
5. _____				
_____ = Total Cover				
Sapling/Shrub Stratum (Plot size: <u>15 feet radius</u>)				
1. <u>N/A</u>				Prevalence Index worksheet: Total % Cover of: _____ Multiply by: _____ OBL species <u>N/A</u> x 1 = _____ FACW species _____ x 2 = _____ FAC species _____ x 3 = _____ FACU species _____ x 4 = _____ UPL species _____ x 5 = _____ Column Totals: _____ (A) _____ (B) Prevalence Index = B/A = _____
2. _____				
3. _____				
4. _____				
5. _____				
_____ = Total Cover				
Herb Stratum (Plot size: <u>5 feet radius</u>)				
1. <u>Paspalum fasciculatum</u>	<u>60%</u>	<u>Yes</u>	<u>FACW</u>	Hydrophytic Vegetation Indicators: <input type="checkbox"/> Rapid Test for Hydrophytic Vegetation <input checked="" type="checkbox"/> Dominance Test is >50% <input type="checkbox"/> Prevalence Index is ≤3.0 ¹ <input type="checkbox"/> Problematic Hydrophytic Vegetation ¹ (Explain) ¹ Indicators of hydric soil and wetland hydrology must be present, unless disturbed or problematic.
2. <u>Ipomoea setifera</u>	<u>10%</u>	<u>No</u>	<u>FACW</u>	
3. <u>Commelina diffusa</u>	<u>30%</u>	<u>Yes</u>	<u>FAC</u>	
4. _____				
5. _____				
6. _____				
7. _____				
8. _____				
_____ = Total Cover				
Woody Vine Stratum (Plot size: <u>30 feet radius</u>)				
1. <u>N/A</u>				Hydrophytic Vegetation Present? Yes <input checked="" type="checkbox"/> No <input type="checkbox"/>
2. _____				
3. _____				
4. _____				
_____ = Total Cover				

Remarks:

The 2016 Wetland Plant List was used to determine indicator status.

SOIL

Sampling Point: EC-11

Profile Description: (Describe to the depth needed to document the indicator or confirm the absence of indicators.)

Depth (inches)	Matrix		Redox Features				Texture	Remarks
	Color (moist)	%	Color (moist)	%	Type ¹	Loc ²		
0-10	10YR 4/2	100%					Clay	

¹Type: C=Concentration, D=Depletion, RM=Reduced Matrix, CS=Covered or Coated Sand Grains. ²Location: PL=Pore Lining, M=Matrix.

Hydric Soil Indicators:

- | | |
|--|---|
| <input type="checkbox"/> Histosol (A1) | <input type="checkbox"/> Sandy Gleyed Matrix (S4) |
| <input type="checkbox"/> Histic Epipedon (A2) | <input type="checkbox"/> Sandy Redox (S5) |
| <input type="checkbox"/> Black Histic (A3) | <input type="checkbox"/> Stripped Matrix (S6) |
| <input checked="" type="checkbox"/> Hydrogen Sulfide (A4) | <input type="checkbox"/> Dark Surface (S7) |
| <input type="checkbox"/> Organic Bodies (A6) | <input type="checkbox"/> Loamy Gleyed Matrix (F2) |
| <input type="checkbox"/> 5 cm Mucky Mineral (A7) | <input type="checkbox"/> Depleted Matrix (F3) |
| <input type="checkbox"/> Muck Presence (A8) | <input type="checkbox"/> Redox Dark Surface (F6) |
| <input type="checkbox"/> Depleted Below Dark Surface (A11) | <input type="checkbox"/> Depleted Dark Surface (F7) |
| <input type="checkbox"/> Thick Dark Surface (A12) | <input type="checkbox"/> Redox Depressions (F8) |

Indicators for Problematic Hydric Soils³:

- Stratified Layers (A5)
- Very Shallow Dark Surface (TF12)
- Other (Explain in Remarks)

³Indicators of hydrophytic vegetation and wetland hydrology must be present, unless disturbed or problematic.

Restrictive Layer (if observed):

Type: N/A
 Depth (inches): N/A

Hydric Soil Present? Yes No

Remarks:

Sampling point is near a headwall that discharges to the north side of PR-3.

HYDROLOGY

Wetland Hydrology Indicators:

Primary Indicators (minimum of one required; check all that apply)

- | | |
|--|---|
| <input type="checkbox"/> Surface Water (A1) | <input type="checkbox"/> Water-Stained Leaves (B9) |
| <input checked="" type="checkbox"/> High Water Table (A2) | <input type="checkbox"/> Aquatic Fauna (B13) |
| <input checked="" type="checkbox"/> Saturation (A3) | <input checked="" type="checkbox"/> Hydrogen Sulfide Odor (C1) |
| <input type="checkbox"/> Water Marks (B1) | <input type="checkbox"/> Oxidized Rhizospheres on Living Roots (C3) |
| <input type="checkbox"/> Sediment Deposits (B2) | <input type="checkbox"/> Presence of Reduced Iron (C4) |
| <input type="checkbox"/> Drift Deposits (B3) | <input type="checkbox"/> Recent Iron Reduction in Tilled Soils (C6) |
| <input type="checkbox"/> Algal Mat or Crust (B4) | <input type="checkbox"/> Thin Muck Surface (C7) |
| <input type="checkbox"/> Iron Deposits (B5) | <input type="checkbox"/> Fiddler Crab Burrows (C10) |
| <input type="checkbox"/> Inundation Visible on Aerial Imagery (B7) | <input type="checkbox"/> Other (Explain in Remarks) |

Secondary Indicators (minimum of two required)

- Surface Soil Cracks (B6)
- Sparsely Vegetated Concave Surface (B8)
- Drainage Patterns (B10)
- Dry-Season Water Table (C2)
- Saturation Visible on Aerial Imagery (C9)
- Geomorphic Position (D2)
- Shallow Aquitard (D3)
- FAC-Neutral Test (D5)

Field Observations:

Surface Water Present? Yes No Depth (inches): _____
 Water Table Present? Yes No Depth (inches): 10
 Saturation Present? (includes capillary fringe) Yes No Depth (inches): 3

Wetland Hydrology Present? Yes No

Describe Recorded Data (stream gauge, monitoring well, aerial photos, previous inspections), if available:

Remarks:

Strong wetland hydrology indicators were found at this sampling point.

WETLAND DETERMINATION DATA FORM – Caribbean Islands Region

Project/Site: Supermercados Econo New Warehouse and Distribution Center Municipality/Town: Canóvanas Sampling Date: September 7, 2016
 Applicant/Owner: Supermercados Econo, Inc. PR or USVI: PR Sampling Point: EC-12
 Investigator(s): Jorge L. Coll Rivera Ward/Estate: Pueblo
 Landform (hillslope, terrace, etc.): Terrace Local relief (concave, convex, none): None Slope (%): 0%
 Lat: 255,449.746 Long: 260,121.258 Datum: State Plane, NAD 83
 Soil Map Unit Name: Gravel Pit (G.P.) NWI classification: UPL

Are climatic / hydrologic conditions on the site typical for this time of year? Yes No (If no, explain in Remarks.)
 Are Vegetation , Soil , or Hydrology significantly disturbed? Are "Normal Circumstances" present? Yes No
 Are Vegetation , Soil , or Hydrology naturally problematic? (If needed, explain any answers in Remarks.)

SUMMARY OF FINDINGS – Attach site map showing sampling point locations, transects, important features, etc.

Hydrophytic Vegetation Present? Yes <input checked="" type="checkbox"/> No <input type="checkbox"/> Hydric Soil Present? Yes <input type="checkbox"/> No <input checked="" type="checkbox"/> Wetland Hydrology Present? Yes <input type="checkbox"/> No <input checked="" type="checkbox"/>	Is the Sampled Area within a Wetland? Yes <input type="checkbox"/> No <input checked="" type="checkbox"/>
Remarks: Sampling point is located within a forested area with a herbaceous understory. This condition keeps humidity within soil surface due to slow evaporation promoted by dense tree canopy.	

VEGETATION – Use scientific names of plants.

Tree Stratum (Plot size: <u>30 feet radius</u>)	Absolute % Cover	Dominant Species?	Indicator Status	Dominance Test worksheet:
1. <u>Albizia procera</u>	80%	Yes	UPL	Number of Dominant Species That Are OBL, FACW, or FAC: <u>3</u> (A)
2. _____				Total Number of Dominant Species Across All Strata: <u>5</u> (B)
3. _____				Percent of Dominant Species That Are OBL, FACW, or FAC: <u>60%</u> (A/B)
4. _____				
5. _____				
80% = Total Cover				
Sapling/Shrub Stratum (Plot size: <u>15 feet radius</u>)	Absolute % Cover	Dominant Species?	Indicator Status	Prevalence Index worksheet:
1. <u>N/A</u>				Total % Cover of: _____ Multiply by: _____
2. _____				OBL species <u>N/A</u> x 1 = _____
3. _____				FACW species _____ x 2 = _____
4. _____				FAC species _____ x 3 = _____
5. _____				FACU species _____ x 4 = _____
_____ = Total Cover				UPL species _____ x 5 = _____
				Column Totals: _____ (A) _____ (B)
				Prevalence Index = B/A = _____
Herb Stratum (Plot size: <u>5 feet radius</u>)	Absolute % Cover	Dominant Species?	Indicator Status	Hydrophytic Vegetation Indicators:
1. <u>Megathyrsus maximus</u>	20%	Yes	FACU	<input type="checkbox"/> Rapid Test for Hydrophytic Vegetation
2. <u>Paullinia pinnata</u>	20%	Yes	FAC	<input checked="" type="checkbox"/> Dominance Test is >50%
3. <u>Commelina diffusa</u>	20%	Yes	FAC	<input type="checkbox"/> Prevalence Index is ≤3.0 ¹
4. <u>Paspalum conjugatum</u>	40%	Yes	FAC	<input type="checkbox"/> Problematic Hydrophytic Vegetation ¹ (Explain)
5. _____				
6. _____				
7. _____				
8. _____				
100% = Total Cover				¹ Indicators of hydric soil and wetland hydrology must be present, unless disturbed or problematic.
Woody Vine Stratum (Plot size: <u>30 feet radius</u>)	Absolute % Cover	Dominant Species?	Indicator Status	Hydrophytic Vegetation Present?
1. <u>N/A</u>				Yes <input checked="" type="checkbox"/> No <input type="checkbox"/>
2. _____				
3. _____				
4. _____				
_____ = Total Cover				

Remarks:

The 2016 Wetland Plant List was used to determine indicator status.

SOIL

Sampling Point: EC-12

Profile Description: (Describe to the depth needed to document the indicator or confirm the absence of indicators.)

Depth (inches)	Matrix		Redox Features				Texture	Remarks
	Color (moist)	%	Color (moist)	%	Type ¹	Loc ²		
0-12	10YR 4/3	100%					Clay	

¹Type: C=Concentration, D=Depletion, RM=Reduced Matrix, CS=Covered or Coated Sand Grains. ²Location: PL=Pore Lining, M=Matrix.

Hydric Soil Indicators:

- | | |
|--|---|
| <input type="checkbox"/> Histosol (A1) | <input type="checkbox"/> Sandy Gleyed Matrix (S4) |
| <input type="checkbox"/> Histic Epipedon (A2) | <input type="checkbox"/> Sandy Redox (S5) |
| <input type="checkbox"/> Black Histic (A3) | <input type="checkbox"/> Stripped Matrix (S6) |
| <input type="checkbox"/> Hydrogen Sulfide (A4) | <input type="checkbox"/> Dark Surface (S7) |
| <input type="checkbox"/> Organic Bodies (A6) | <input type="checkbox"/> Loamy Gleyed Matrix (F2) |
| <input type="checkbox"/> 5 cm Mucky Mineral (A7) | <input type="checkbox"/> Depleted Matrix (F3) |
| <input type="checkbox"/> Muck Presence (A8) | <input type="checkbox"/> Redox Dark Surface (F6) |
| <input type="checkbox"/> Depleted Below Dark Surface (A11) | <input type="checkbox"/> Depleted Dark Surface (F7) |
| <input type="checkbox"/> Thick Dark Surface (A12) | <input type="checkbox"/> Redox Depressions (F8) |

Indicators for Problematic Hydric Soils³:

- Stratified Layers (A5)
- Very Shallow Dark Surface (TF12)
- Other (Explain in Remarks)

³Indicators of hydrophytic vegetation and wetland hydrology must be present, unless disturbed or problematic.

Restrictive Layer (if observed):

Type: N/A
 Depth (inches): N/A

Hydric Soil Present? Yes No

Remarks:

No hydric soil indicators were found at this sampling point.

HYDROLOGY

Wetland Hydrology Indicators:

Primary Indicators (minimum of one required; check all that apply)

- | | |
|--|---|
| <input type="checkbox"/> Surface Water (A1) | <input type="checkbox"/> Water-Stained Leaves (B9) |
| <input type="checkbox"/> High Water Table (A2) | <input type="checkbox"/> Aquatic Fauna (B13) |
| <input type="checkbox"/> Saturation (A3) | <input type="checkbox"/> Hydrogen Sulfide Odor (C1) |
| <input type="checkbox"/> Water Marks (B1) | <input type="checkbox"/> Oxidized Rhizospheres on Living Roots (C3) |
| <input type="checkbox"/> Sediment Deposits (B2) | <input type="checkbox"/> Presence of Reduced Iron (C4) |
| <input type="checkbox"/> Drift Deposits (B3) | <input type="checkbox"/> Recent Iron Reduction in Tilled Soils (C6) |
| <input type="checkbox"/> Algal Mat or Crust (B4) | <input type="checkbox"/> Thin Muck Surface (C7) |
| <input type="checkbox"/> Iron Deposits (B5) | <input type="checkbox"/> Fiddler Crab Burrows (C10) |
| <input type="checkbox"/> Inundation Visible on Aerial Imagery (B7) | <input type="checkbox"/> Other (Explain in Remarks) |

Secondary Indicators (minimum of two required)

- Surface Soil Cracks (B6)
- Sparsely Vegetated Concave Surface (B8)
- Drainage Patterns (B10)
- Dry-Season Water Table (C2)
- Saturation Visible on Aerial Imagery (C9)
- Geomorphic Position (D2)
- Shallow Aquitard (D3)
- FAC-Neutral Test (D5)

Field Observations:

Surface Water Present? Yes No Depth (inches): _____
 Water Table Present? Yes No Depth (inches): _____
 Saturation Present? (includes capillary fringe) Yes No Depth (inches): _____

Wetland Hydrology Present? Yes No

Describe Recorded Data (stream gauge, monitoring well, aerial photos, previous inspections), if available:

Remarks:

No wetland hydrology indicators were found at this sampling point.

WETLAND DETERMINATION DATA FORM – Caribbean Islands Region

Project/Site: Supermercados Econo New Warehouse and Distribution Center Municipality/Town: Canóvanas Sampling Date: September 7, 2016

Applicant/Owner: Supermercados Econo, Inc. PR or USVI: PR Sampling Point: EC-13

Investigator(s): Jorge L. Coll Rivera Ward/Estate: Pueblo

Landform (hillslope, terrace, etc.): Terrace Local relief (concave, convex, none): None Slope (%): 0%

Lat: 259,948.232 Long: 259,948.250 Datum: State Plane, NAD 83

Soil Map Unit Name: Gravel Pit (G.P.) NWI classification: UPL

Are climatic / hydrologic conditions on the site typical for this time of year? Yes No (If no, explain in Remarks.)

Are Vegetation , Soil , or Hydrology significantly disturbed? Are "Normal Circumstances" present? Yes No

Are Vegetation , Soil , or Hydrology naturally problematic? (If needed, explain any answers in Remarks.)

SUMMARY OF FINDINGS – Attach site map showing sampling point locations, transects, important features, etc.

Hydrophytic Vegetation Present? Yes <input type="checkbox"/> No <input checked="" type="checkbox"/> Hydric Soil Present? Yes <input type="checkbox"/> No <input checked="" type="checkbox"/> Wetland Hydrology Present? Yes <input type="checkbox"/> No <input checked="" type="checkbox"/>	Is the Sampled Area within a Wetland? Yes <input type="checkbox"/> No <input checked="" type="checkbox"/>
Remarks: Sampling point is located within a forested area with a herbaceous understory. This condition keeps humidity within soil surface due to slow evaporation promoted by dense tree canopy.	

VEGETATION – Use scientific names of plants.

Tree Stratum (Plot size: <u>30 feet radius</u>)	Absolute % Cover	Dominant Species?	Indicator Status	Dominance Test worksheet:																
1. <u>Albizia procera</u>	<u>50%</u>	<u>Yes</u>	<u>UPL</u>	Number of Dominant Species That Are OBL, FACW, or FAC: <u>0</u> (A)																
2. _____	_____	_____	_____	Total Number of Dominant Species Across All Strata: <u>2</u> (B)																
3. _____	_____	_____	_____	Percent of Dominant Species That Are OBL, FACW, or FAC: <u>0%</u> (A/B)																
4. _____	_____	_____	_____	Prevalence Index worksheet: <table style="width:100%; border-collapse: collapse;"> <tr> <td style="width:50%; text-align: center;">Total % Cover of:</td> <td style="width:50%; text-align: center;">Multiply by:</td> </tr> <tr> <td>OBL species <u>0</u></td> <td>x 1 = <u>0%</u></td> </tr> <tr> <td>FACW species <u>0</u></td> <td>x 2 = <u>0%</u></td> </tr> <tr> <td>FAC species <u>0</u></td> <td>x 3 = <u>0%</u></td> </tr> <tr> <td>FACU species <u>50</u></td> <td>x 4 = <u>200%</u></td> </tr> <tr> <td>UPL species <u>50</u></td> <td>x 5 = <u>250%</u></td> </tr> <tr> <td>Column Totals: <u>100</u> (A)</td> <td><u>450</u> (B)</td> </tr> <tr> <td colspan="2" style="text-align: center;">Prevalence Index = B/A = <u>4.5</u></td> </tr> </table>	Total % Cover of:	Multiply by:	OBL species <u>0</u>	x 1 = <u>0%</u>	FACW species <u>0</u>	x 2 = <u>0%</u>	FAC species <u>0</u>	x 3 = <u>0%</u>	FACU species <u>50</u>	x 4 = <u>200%</u>	UPL species <u>50</u>	x 5 = <u>250%</u>	Column Totals: <u>100</u> (A)	<u>450</u> (B)	Prevalence Index = B/A = <u>4.5</u>	
Total % Cover of:	Multiply by:																			
OBL species <u>0</u>	x 1 = <u>0%</u>																			
FACW species <u>0</u>	x 2 = <u>0%</u>																			
FAC species <u>0</u>	x 3 = <u>0%</u>																			
FACU species <u>50</u>	x 4 = <u>200%</u>																			
UPL species <u>50</u>	x 5 = <u>250%</u>																			
Column Totals: <u>100</u> (A)	<u>450</u> (B)																			
Prevalence Index = B/A = <u>4.5</u>																				
5. _____	_____	_____	_____																	
50% = Total Cover																				
Sapling/Shrub Stratum (Plot size: <u>15 feet radius</u>)																				
1. <u>N/A</u>	_____	_____	_____	Hydrophytic Vegetation Indicators: <input type="checkbox"/> Rapid Test for Hydrophytic Vegetation <input type="checkbox"/> Dominance Test is >50% <input type="checkbox"/> Prevalence Index is ≤3.0 ¹ <input type="checkbox"/> Problematic Hydrophytic Vegetation ¹ (Explain)																
2. _____	_____	_____	_____																	
3. _____	_____	_____	_____																	
4. _____	_____	_____	_____																	
5. _____	_____	_____	_____																	
6. _____	_____	_____	_____																	
7. _____	_____	_____	_____																	
8. _____	_____	_____	_____																	
_____ = Total Cover																				
Woody Vine Stratum (Plot size: <u>30 feet radius</u>)																				
1. <u>N/A</u>	_____	_____	_____	Hydrophytic Vegetation Present? Yes <input type="checkbox"/> No <input checked="" type="checkbox"/>																
2. _____	_____	_____	_____																	
3. _____	_____	_____	_____																	
4. _____	_____	_____	_____																	
_____ = Total Cover																				

Remarks:

The 2016 Wetland Plant List was used to determine indicator status.

SOIL

Sampling Point: EC-13

Profile Description: (Describe to the depth needed to document the indicator or confirm the absence of indicators.)

Depth (inches)	Matrix		Redox Features				Texture	Remarks
	Color (moist)	%	Color (moist)	%	Type ¹	Loc ²		

¹Type: C=Concentration, D=Depletion, RM=Reduced Matrix, CS=Covered or Coated Sand Grains. ²Location: PL=Pore Lining, M=Matrix.

Hydric Soil Indicators:

- | | |
|--|---|
| <input type="checkbox"/> Histosol (A1) | <input type="checkbox"/> Sandy Gleyed Matrix (S4) |
| <input type="checkbox"/> Histic Epipedon (A2) | <input type="checkbox"/> Sandy Redox (S5) |
| <input type="checkbox"/> Black Histic (A3) | <input type="checkbox"/> Stripped Matrix (S6) |
| <input type="checkbox"/> Hydrogen Sulfide (A4) | <input type="checkbox"/> Dark Surface (S7) |
| <input type="checkbox"/> Organic Bodies (A6) | <input type="checkbox"/> Loamy Gleyed Matrix (F2) |
| <input type="checkbox"/> 5 cm Mucky Mineral (A7) | <input type="checkbox"/> Depleted Matrix (F3) |
| <input type="checkbox"/> Muck Presence (A8) | <input type="checkbox"/> Redox Dark Surface (F6) |
| <input type="checkbox"/> Depleted Below Dark Surface (A11) | <input type="checkbox"/> Depleted Dark Surface (F7) |
| <input type="checkbox"/> Thick Dark Surface (A12) | <input type="checkbox"/> Redox Depressions (F8) |

Indicators for Problematic Hydric Soils³:

- Stratified Layers (A5)
- Very Shallow Dark Surface (TF12)
- Other (Explain in Remarks)

³Indicators of hydrophytic vegetation and wetland hydrology must be present, unless disturbed or problematic.

Restrictive Layer (if observed):

Type: N/A
 Depth (inches): N/A

Hydric Soil Present? Yes No

Remarks:

No hydric soil indicators were found at this sampling point. Exposed rock outcrop.

HYDROLOGY

Wetland Hydrology Indicators:

Primary Indicators (minimum of one required; check all that apply)

- | | |
|--|---|
| <input type="checkbox"/> Surface Water (A1) | <input type="checkbox"/> Water-Stained Leaves (B9) |
| <input type="checkbox"/> High Water Table (A2) | <input type="checkbox"/> Aquatic Fauna (B13) |
| <input type="checkbox"/> Saturation (A3) | <input type="checkbox"/> Hydrogen Sulfide Odor (C1) |
| <input type="checkbox"/> Water Marks (B1) | <input type="checkbox"/> Oxidized Rhizospheres on Living Roots (C3) |
| <input type="checkbox"/> Sediment Deposits (B2) | <input type="checkbox"/> Presence of Reduced Iron (C4) |
| <input type="checkbox"/> Drift Deposits (B3) | <input type="checkbox"/> Recent Iron Reduction in Tilled Soils (C6) |
| <input type="checkbox"/> Algal Mat or Crust (B4) | <input type="checkbox"/> Thin Muck Surface (C7) |
| <input type="checkbox"/> Iron Deposits (B5) | <input type="checkbox"/> Fiddler Crab Burrows (C10) |
| <input type="checkbox"/> Inundation Visible on Aerial Imagery (B7) | <input type="checkbox"/> Other (Explain in Remarks) |

Secondary Indicators (minimum of two required)

- Surface Soil Cracks (B6)
- Sparsely Vegetated Concave Surface (B8)
- Drainage Patterns (B10)
- Dry-Season Water Table (C2)
- Saturation Visible on Aerial Imagery (C9)
- Geomorphic Position (D2)
- Shallow Aquitard (D3)
- FAC-Neutral Test (D5)

Field Observations:

Surface Water Present? Yes No Depth (inches): _____
 Water Table Present? Yes No Depth (inches): _____
 Saturation Present? Yes No Depth (inches): _____
 (includes capillary fringe)

Wetland Hydrology Present? Yes No

Describe Recorded Data (stream gauge, monitoring well, aerial photos, previous inspections), if available:

Remarks:

No wetland hydrology indicators were found at this sampling point.

WETLAND DETERMINATION DATA FORM – Caribbean Islands Region

Project/Site: Supermercados Econo New Warehouse and Distribution Center Municipality/Town: Canóvanas Sampling Date: September 7, 2016

Applicant/Owner: Supermercados Econo, Inc. PR or USVI: PR Sampling Point: EC-14

Investigator(s): Jorge L. Coll Rivera Ward/Estate: Pueblo

Landform (hillslope, terrace, etc.): Terrace Local relief (concave, convex, none): None Slope (%): 0%

Lat: 259,948.232 Long: 259,948.250 Datum: State Plane, NAD 83

Soil Map Unit Name: Caguabo clay loam 20-60% slopes (CbF2) NWI classification: UPL

Are climatic / hydrologic conditions on the site typical for this time of year? Yes No (If no, explain in Remarks.)

Are Vegetation , Soil , or Hydrology significantly disturbed? Are "Normal Circumstances" present? Yes No

Are Vegetation , Soil , or Hydrology naturally problematic? (If needed, explain any answers in Remarks.)

SUMMARY OF FINDINGS – Attach site map showing sampling point locations, transects, important features, etc.

Hydrophytic Vegetation Present?	Yes <input checked="" type="checkbox"/>	No <input type="checkbox"/>	Is the Sampled Area within a Wetland?	Yes <input type="checkbox"/>	No <input checked="" type="checkbox"/>
Hydric Soil Present?	Yes <input type="checkbox"/>	No <input checked="" type="checkbox"/>			
Wetland Hydrology Present?	Yes <input type="checkbox"/>	No <input checked="" type="checkbox"/>			

Remarks:

Sampling point is located within an open area on top of a rock outcrop.

VEGETATION – Use scientific names of plants.

<u>Tree Stratum</u> (Plot size: <u>30 feet radius</u>)	Absolute % Cover	Dominant Species?	Indicator Status	Dominance Test worksheet:
1. <u>N/A</u>				Number of Dominant Species That Are OBL, FACW, or FAC: <u>2</u> (A)
2. _____				Total Number of Dominant Species Across All Strata: <u>2</u> (B)
3. _____				Percent of Dominant Species That Are OBL, FACW, or FAC: <u>100%</u> (A/B)
4. _____				
5. _____				
_____ = Total Cover				
<u>Sapling/Shrub Stratum</u> (Plot size: <u>15 feet radius</u>)				Prevalence Index worksheet:
1. <u>N/A</u>				Total % Cover of: _____ Multiply by: _____
2. _____				OBL species <u>N/A</u> x 1 = _____
3. _____				FACW species _____ x 2 = _____
4. _____				FAC species _____ x 3 = _____
5. _____				FACU species _____ x 4 = _____
_____ = Total Cover				UPL species _____ x 5 = _____
				Column Totals: _____ (A) _____ (B)
				Prevalence Index = B/A = _____
<u>Herb Stratum</u> (Plot size: <u>5 feet radius</u>)				Hydrophytic Vegetation Indicators:
1. <u>Andropogon bicomis</u>	<u>80%</u>	<u>Yes</u>	<u>FAC</u>	<input type="checkbox"/> Rapid Test for Hydrophytic Vegetation
2. <u>Ipomoea indica</u>	<u>20%</u>	<u>Yes</u>	<u>FAC</u>	<input checked="" type="checkbox"/> Dominance Test is >50%
3. _____				<input type="checkbox"/> Prevalence Index is ≤3.0 ¹
4. _____				<input type="checkbox"/> Problematic Hydrophytic Vegetation ¹ (Explain)
5. _____				
6. _____				
7. _____				
8. _____				
<u>100%</u> = Total Cover				¹ Indicators of hydric soil and wetland hydrology must be present, unless disturbed or problematic.
<u>Woody Vine Stratum</u> (Plot size: <u>30 feet radius</u>)				Hydrophytic Vegetation Present?
1. <u>N/A</u>				Yes <input checked="" type="checkbox"/> No <input type="checkbox"/>
2. _____				
3. _____				
4. _____				
_____ = Total Cover				

Remarks:

The 2016 Wetland Plant List was used to determine indicator status.

SOIL

Sampling Point: EC-14

Profile Description: (Describe to the depth needed to document the indicator or confirm the absence of indicators.)

Depth (inches)	Matrix		Redox Features				Texture	Remarks
	Color (moist)	%	Color (moist)	%	Type ¹	Loc ²		

¹Type: C=Concentration, D=Depletion, RM=Reduced Matrix, CS=Covered or Coated Sand Grains. ²Location: PL=Pore Lining, M=Matrix.

<p>Hydric Soil Indicators:</p> <input type="checkbox"/> Histosol (A1) <input type="checkbox"/> Histic Epipedon (A2) <input type="checkbox"/> Black Histic (A3) <input type="checkbox"/> Hydrogen Sulfide (A4) <input type="checkbox"/> Organic Bodies (A6) <input type="checkbox"/> 5 cm Mucky Mineral (A7) <input type="checkbox"/> Muck Presence (A8) <input type="checkbox"/> Depleted Below Dark Surface (A11) <input type="checkbox"/> Thick Dark Surface (A12)	<input type="checkbox"/> Sandy Gleyed Matrix (S4) <input type="checkbox"/> Sandy Redox (S5) <input type="checkbox"/> Stripped Matrix (S6) <input type="checkbox"/> Dark Surface (S7) <input type="checkbox"/> Loamy Gleyed Matrix (F2) <input type="checkbox"/> Depleted Matrix (F3) <input type="checkbox"/> Redox Dark Surface (F6) <input type="checkbox"/> Depleted Dark Surface (F7) <input type="checkbox"/> Redox Depressions (F8)	<p>Indicators for Problematic Hydric Soils³:</p> <input type="checkbox"/> Stratified Layers (A5) <input type="checkbox"/> Very Shallow Dark Surface (TF12) <input type="checkbox"/> Other (Explain in Remarks)
---	---	--

³Indicators of hydrophytic vegetation and wetland hydrology must be present, unless disturbed or problematic.

<p>Restrictive Layer (if observed): Type: <u>N/A</u> Depth (inches): <u>N/A</u></p>	<p>Hydric Soil Present? Yes <input type="checkbox"/> No <input checked="" type="checkbox"/></p>
--	---

Remarks:

No hydric soil indicators were found at this sampling point. Exposed rock outcrop.

HYDROLOGY

<p>Wetland Hydrology Indicators:</p> <p>Primary Indicators (minimum of one required; check all that apply)</p> <input type="checkbox"/> Surface Water (A1) <input type="checkbox"/> High Water Table (A2) <input type="checkbox"/> Saturation (A3) <input type="checkbox"/> Water Marks (B1) <input type="checkbox"/> Sediment Deposits (B2) <input type="checkbox"/> Drift Deposits (B3) <input type="checkbox"/> Algal Mat or Crust (B4) <input type="checkbox"/> Iron Deposits (B5) <input type="checkbox"/> Inundation Visible on Aerial Imagery (B7)		<p>Secondary Indicators (minimum of two required)</p> <input type="checkbox"/> Water-Stained Leaves (B9) <input type="checkbox"/> Aquatic Fauna (B13) <input type="checkbox"/> Hydrogen Sulfide Odor (C1) <input type="checkbox"/> Oxidized Rhizospheres on Living Roots (C3) <input type="checkbox"/> Presence of Reduced Iron (C4) <input type="checkbox"/> Recent Iron Reduction in Tilled Soils (C6) <input type="checkbox"/> Thin Muck Surface (C7) <input type="checkbox"/> Fiddler Crab Burrows (C10) <input type="checkbox"/> Other (Explain in Remarks)		<input type="checkbox"/> Surface Soil Cracks (B6) <input type="checkbox"/> Sparsely Vegetated Concave Surface (B8) <input type="checkbox"/> Drainage Patterns (B10) <input type="checkbox"/> Dry-Season Water Table (C2) <input type="checkbox"/> Saturation Visible on Aerial Imagery (C9) <input type="checkbox"/> Geomorphic Position (D2) <input type="checkbox"/> Shallow Aquitard (D3) <input type="checkbox"/> FAC-Neutral Test (D5)	
--	--	--	--	--	--

<p>Field Observations:</p> Surface Water Present? Yes <input type="checkbox"/> No <input checked="" type="checkbox"/> Depth (inches): _____ Water Table Present? Yes <input type="checkbox"/> No <input checked="" type="checkbox"/> Depth (inches): _____ Saturation Present? Yes <input type="checkbox"/> No <input checked="" type="checkbox"/> Depth (inches): _____ (includes capillary fringe)	<p>Wetland Hydrology Present? Yes <input type="checkbox"/> No <input checked="" type="checkbox"/></p>
--	---

Describe Recorded Data (stream gauge, monitoring well, aerial photos, previous inspections), if available:

Remarks:

No wetland hydrology indicators were found at this sampling point.

WETLAND DETERMINATION DATA FORM – Caribbean Islands Region

Project/Site: Supermercados Econo New Warehouse and Distribution Center Municipality/Town: Canóvanas Sampling Date: September 7, 2016

Applicant/Owner: Supermercados Econo, Inc. PR or USVI: PR Sampling Point: EC-15

Investigator(s): Jorge L. Coll Rivera Ward/Estate: Pueblo

Landform (hillslope, terrace, etc.): Terrace Local relief (concave, convex, none): None Slope (%): 0%

Lat: 255,817.866 Long: 259,683.213 Datum: State Plane, NAD 83

Soil Map Unit Name: Mabi clay (MaB) NWI classification: NP

Are climatic / hydrologic conditions on the site typical for this time of year? Yes No (If no, explain in Remarks.)

Are Vegetation , Soil , or Hydrology significantly disturbed? Are "Normal Circumstances" present? Yes No

Are Vegetation , Soil , or Hydrology naturally problematic? (If needed, explain any answers in Remarks.)

SUMMARY OF FINDINGS – Attach site map showing sampling point locations, transects, important features, etc.

Hydrophytic Vegetation Present? Yes <input type="checkbox"/> No <input checked="" type="checkbox"/> Hydric Soil Present? Yes <input type="checkbox"/> No <input checked="" type="checkbox"/> Wetland Hydrology Present? Yes <input type="checkbox"/> No <input checked="" type="checkbox"/>	Is the Sampled Area within a Wetland? Yes <input type="checkbox"/> No <input checked="" type="checkbox"/>
---	---

Remarks:

Sampling point is located within the quarry operational area.

VEGETATION – Use scientific names of plants.

Tree Stratum (Plot size: <u>30 feet radius</u>)	Absolute % Cover	Dominant Species?	Indicator Status	Dominance Test worksheet:
1. <u>N/A</u>				Number of Dominant Species That Are OBL, FACW, or FAC: <u>N/A</u> (A) Total Number of Dominant Species Across All Strata: _____ (B) Percent of Dominant Species That Are OBL, FACW, or FAC: _____ (A/B)
2. _____				
3. _____				
4. _____				
5. _____				
_____ = Total Cover				Prevalence Index worksheet: Total % Cover of: _____ Multiply by: _____ OBL species <u>N/A</u> x 1 = _____ FACW species _____ x 2 = _____ FAC species _____ x 3 = _____ FACU species _____ x 4 = _____ UPL species _____ x 5 = _____ Column Totals: _____ (A) _____ (B) Prevalence Index = B/A = _____
Sapling/Shrub Stratum (Plot size: <u>15 feet radius</u>)				
1. <u>N/A</u>				
2. _____				
3. _____				
4. _____				
5. _____				
_____ = Total Cover				
Herb Stratum (Plot size: <u>5 feet radius</u>)				
1. <u>N/A</u>				Hydrophytic Vegetation Indicators: <input type="checkbox"/> Rapid Test for Hydrophytic Vegetation <input type="checkbox"/> Dominance Test is >50% <input type="checkbox"/> Prevalence Index is ≤3.0 ¹ <input type="checkbox"/> Problematic Hydrophytic Vegetation ¹ (Explain) ¹ Indicators of hydric soil and wetland hydrology must be present, unless disturbed or problematic.
2. _____				
3. _____				
4. _____				
5. _____				
6. _____				
7. _____				
8. _____				
_____ = Total Cover				
Woody Vine Stratum (Plot size: <u>30 feet radius</u>)				
1. <u>N/A</u>				Hydrophytic Vegetation Present? Yes <input type="checkbox"/> No <input checked="" type="checkbox"/>
2. _____				
3. _____				
4. _____				
_____ = Total Cover				

Remarks:

The 2016 Wetland Plant List was used to determine indicator status.

SOIL

Sampling Point: EC-15

Profile Description: (Describe to the depth needed to document the indicator or confirm the absence of indicators.)

Depth (inches)	Matrix		Redox Features				Texture	Remarks
	Color (moist)	%	Color (moist)	%	Type ¹	Loc ²		

¹Type: C=Concentration, D=Depletion, RM=Reduced Matrix, CS=Covered or Coated Sand Grains. ²Location: PL=Pore Lining, M=Matrix.

Hydric Soil Indicators:

- | | |
|--|---|
| <input type="checkbox"/> Histosol (A1) | <input type="checkbox"/> Sandy Gleyed Matrix (S4) |
| <input type="checkbox"/> Histic Epipedon (A2) | <input type="checkbox"/> Sandy Redox (S5) |
| <input type="checkbox"/> Black Histic (A3) | <input type="checkbox"/> Stripped Matrix (S6) |
| <input type="checkbox"/> Hydrogen Sulfide (A4) | <input type="checkbox"/> Dark Surface (S7) |
| <input type="checkbox"/> Organic Bodies (A6) | <input type="checkbox"/> Loamy Gleyed Matrix (F2) |
| <input type="checkbox"/> 5 cm Mucky Mineral (A7) | <input type="checkbox"/> Depleted Matrix (F3) |
| <input type="checkbox"/> Muck Presence (A8) | <input type="checkbox"/> Redox Dark Surface (F6) |
| <input type="checkbox"/> Depleted Below Dark Surface (A11) | <input type="checkbox"/> Depleted Dark Surface (F7) |
| <input type="checkbox"/> Thick Dark Surface (A12) | <input type="checkbox"/> Redox Depressions (F8) |

Indicators for Problematic Hydric Soils³:

- Stratified Layers (A5)
- Very Shallow Dark Surface (TF12)
- Other (Explain in Remarks)

³Indicators of hydrophytic vegetation and wetland hydrology must be present, unless disturbed or problematic.

Restrictive Layer (if observed):

Type: N/A
 Depth (inches): N/A

Hydric Soil Present? Yes No

Remarks:

Sampling point is located within the quarry operational area.

HYDROLOGY

Wetland Hydrology Indicators:

Primary Indicators (minimum of one required; check all that apply)

- | | |
|--|---|
| <input type="checkbox"/> Surface Water (A1) | <input type="checkbox"/> Water-Stained Leaves (B9) |
| <input type="checkbox"/> High Water Table (A2) | <input type="checkbox"/> Aquatic Fauna (B13) |
| <input type="checkbox"/> Saturation (A3) | <input type="checkbox"/> Hydrogen Sulfide Odor (C1) |
| <input type="checkbox"/> Water Marks (B1) | <input type="checkbox"/> Oxidized Rhizospheres on Living Roots (C3) |
| <input type="checkbox"/> Sediment Deposits (B2) | <input type="checkbox"/> Presence of Reduced Iron (C4) |
| <input type="checkbox"/> Drift Deposits (B3) | <input type="checkbox"/> Recent Iron Reduction in Tilled Soils (C6) |
| <input type="checkbox"/> Algal Mat or Crust (B4) | <input type="checkbox"/> Thin Muck Surface (C7) |
| <input type="checkbox"/> Iron Deposits (B5) | <input type="checkbox"/> Fiddler Crab Burrows (C10) |
| <input type="checkbox"/> Inundation Visible on Aerial Imagery (B7) | <input type="checkbox"/> Other (Explain in Remarks) |

Secondary Indicators (minimum of two required)

- Surface Soil Cracks (B6)
- Sparsely Vegetated Concave Surface (B8)
- Drainage Patterns (B10)
- Dry-Season Water Table (C2)
- Saturation Visible on Aerial Imagery (C9)
- Geomorphic Position (D2)
- Shallow Aquitard (D3)
- FAC-Neutral Test (D5)

Field Observations:

Surface Water Present? Yes No Depth (inches): _____
 Water Table Present? Yes No Depth (inches): _____
 Saturation Present? Yes No Depth (inches): _____
 (includes capillary fringe)

Wetland Hydrology Present? Yes No

Describe Recorded Data (stream gauge, monitoring well, aerial photos, previous inspections), if available:

Remarks:

Sampling point is located within the quarry operational area.

WETLAND DETERMINATION DATA FORM – Caribbean Islands Region

Project/Site: Supermercados Econo New Warehouse and Distribution Center Municipality/Town: Canóvanas Sampling Date: September 7, 2016
 Applicant/Owner: Supermercados Econo, Inc. PR or USVI: PR Sampling Point: EC-16
 Investigator(s): Jorge L. Coll Rivera Ward/Estate: Pueblo
 Landform (hillslope, terrace, etc.): Terrace Local relief (concave, convex, none): None Slope (%): 0%
 Lat: 255,468.738 Long: 259,524.792 Datum: State Plane, NAD 83
 Soil Map Unit Name: Caguabo clay loam 20-60% slopes (CbF2) NWI classification: NP

Are climatic / hydrologic conditions on the site typical for this time of year? Yes No (If no, explain in Remarks.)
 Are Vegetation , Soil , or Hydrology significantly disturbed? Are "Normal Circumstances" present? Yes No
 Are Vegetation , Soil , or Hydrology naturally problematic? (If needed, explain any answers in Remarks.)

SUMMARY OF FINDINGS – Attach site map showing sampling point locations, transects, important features, etc.

Hydrophytic Vegetation Present? Yes <input type="checkbox"/> No <input checked="" type="checkbox"/> Hydric Soil Present? Yes <input type="checkbox"/> No <input checked="" type="checkbox"/> Wetland Hydrology Present? Yes <input type="checkbox"/> No <input checked="" type="checkbox"/>	Is the Sampled Area within a Wetland? Yes <input type="checkbox"/> No <input checked="" type="checkbox"/>
---	---

Remarks:

Sampling point is located within the quarry operational area.

VEGETATION – Use scientific names of plants.

<u>Tree Stratum</u> (Plot size: <u>30 feet radius</u>)	Absolute % Cover	Dominant Species?	Indicator Status	Dominance Test worksheet:
1. <u>N/A</u>				Number of Dominant Species That Are OBL, FACW, or FAC: <u>N/A</u> (A)
2. _____				Total Number of Dominant Species Across All Strata: _____ (B)
3. _____				Percent of Dominant Species That Are OBL, FACW, or FAC: _____ (A/B)
4. _____				
5. _____				
_____ = Total Cover				
<u>Sapling/Shrub Stratum</u> (Plot size: <u>15 feet radius</u>)				Prevalence Index worksheet:
1. <u>N/A</u>				Total % Cover of: _____ Multiply by: _____
2. _____				OBL species <u>N/A</u> x 1 = _____
3. _____				FACW species _____ x 2 = _____
4. _____				FAC species _____ x 3 = _____
5. _____				FACU species _____ x 4 = _____
				UPL species _____ x 5 = _____
_____ = Total Cover				Column Totals: _____ (A) _____ (B)
				Prevalence Index = B/A = _____
<u>Herb Stratum</u> (Plot size: <u>5 feet radius</u>)				Hydrophytic Vegetation Indicators:
1. <u>N/A</u>				<input type="checkbox"/> Rapid Test for Hydrophytic Vegetation
2. _____				<input type="checkbox"/> Dominance Test is >50%
3. _____				<input type="checkbox"/> Prevalence Index is ≤3.0 ¹
4. _____				<input type="checkbox"/> Problematic Hydrophytic Vegetation ¹ (Explain)
5. _____				
6. _____				
7. _____				
8. _____				
_____ = Total Cover				
<u>Woody Vine Stratum</u> (Plot size: <u>30 feet radius</u>)				
1. <u>N/A</u>				
2. _____				
3. _____				
4. _____				
_____ = Total Cover				
				Hydrophytic Vegetation Present? Yes <input type="checkbox"/> No <input checked="" type="checkbox"/>

Remarks:

The 2016 Wetland Plant List was used to determine indicator status.

SOIL

Sampling Point: EC-16

Profile Description: (Describe to the depth needed to document the indicator or confirm the absence of indicators.)

Depth (inches)	Matrix		Redox Features				Texture	Remarks
	Color (moist)	%	Color (moist)	%	Type ¹	Loc ²		

¹Type: C=Concentration, D=Depletion, RM=Reduced Matrix, CS=Covered or Coated Sand Grains. ²Location: PL=Pore Lining, M=Matrix.

Hydric Soil Indicators:

- | | |
|--|---|
| <input type="checkbox"/> Histosol (A1) | <input type="checkbox"/> Sandy Gleyed Matrix (S4) |
| <input type="checkbox"/> Histic Epipedon (A2) | <input type="checkbox"/> Sandy Redox (S5) |
| <input type="checkbox"/> Black Histic (A3) | <input type="checkbox"/> Stripped Matrix (S6) |
| <input type="checkbox"/> Hydrogen Sulfide (A4) | <input type="checkbox"/> Dark Surface (S7) |
| <input type="checkbox"/> Organic Bodies (A6) | <input type="checkbox"/> Loamy Gleyed Matrix (F2) |
| <input type="checkbox"/> 5 cm Mucky Mineral (A7) | <input type="checkbox"/> Depleted Matrix (F3) |
| <input type="checkbox"/> Muck Presence (A8) | <input type="checkbox"/> Redox Dark Surface (F6) |
| <input type="checkbox"/> Depleted Below Dark Surface (A11) | <input type="checkbox"/> Depleted Dark Surface (F7) |
| <input type="checkbox"/> Thick Dark Surface (A12) | <input type="checkbox"/> Redox Depressions (F8) |

Indicators for Problematic Hydric Soils³:

- Stratified Layers (A5)
- Very Shallow Dark Surface (TF12)
- Other (Explain in Remarks)

³Indicators of hydrophytic vegetation and wetland hydrology must be present, unless disturbed or problematic.

Restrictive Layer (if observed):

Type: N/A
 Depth (inches): N/A

Hydric Soil Present? Yes No

Remarks:

Sampling point is located within the quarry operational area.

HYDROLOGY

Wetland Hydrology Indicators:

Primary Indicators (minimum of one required; check all that apply)

- | | |
|--|---|
| <input type="checkbox"/> Surface Water (A1) | <input type="checkbox"/> Water-Stained Leaves (B9) |
| <input type="checkbox"/> High Water Table (A2) | <input type="checkbox"/> Aquatic Fauna (B13) |
| <input type="checkbox"/> Saturation (A3) | <input type="checkbox"/> Hydrogen Sulfide Odor (C1) |
| <input type="checkbox"/> Water Marks (B1) | <input type="checkbox"/> Oxidized Rhizospheres on Living Roots (C3) |
| <input type="checkbox"/> Sediment Deposits (B2) | <input type="checkbox"/> Presence of Reduced Iron (C4) |
| <input type="checkbox"/> Drift Deposits (B3) | <input type="checkbox"/> Recent Iron Reduction in Tilled Soils (C6) |
| <input type="checkbox"/> Algal Mat or Crust (B4) | <input type="checkbox"/> Thin Muck Surface (C7) |
| <input type="checkbox"/> Iron Deposits (B5) | <input type="checkbox"/> Fiddler Crab Burrows (C10) |
| <input type="checkbox"/> Inundation Visible on Aerial Imagery (B7) | <input type="checkbox"/> Other (Explain in Remarks) |

Secondary Indicators (minimum of two required)

- Surface Soil Cracks (B6)
- Sparsely Vegetated Concave Surface (B8)
- Drainage Patterns (B10)
- Dry-Season Water Table (C2)
- Saturation Visible on Aerial Imagery (C9)
- Geomorphic Position (D2)
- Shallow Aquitard (D3)
- FAC-Neutral Test (D5)

Field Observations:

Surface Water Present? Yes No Depth (inches): _____
 Water Table Present? Yes No Depth (inches): _____
 Saturation Present? (includes capillary fringe) Yes No Depth (inches): _____

Wetland Hydrology Present? Yes No

Describe Recorded Data (stream gauge, monitoring well, aerial photos, previous inspections), if available:

Remarks:

Sampling point is located within the quarry operational area.

WETLAND DETERMINATION DATA FORM – Caribbean Islands Region

Project/Site: Supermercados Econo New Warehouse and Distribution Center Municipality/Town: Canóvanas Sampling Date: September 7, 2016
 Applicant/Owner: Supermercados Econo, Inc. PR or USVI: PR Sampling Point: EC-17
 Investigator(s): Jorge L. Coll Rivera Ward/Estate: Pueblo
 Landform (hillslope, terrace, etc.): Drainage ditch Local relief (concave, convex, none): concave (canal) Slope (%): 1-3%
 Lat: 255,533.000 Long: 260,161.578 Datum: State Plane, NAD 83
 Soil Map Unit Name: Mabi clay (MaB) NWI classification: UPL

Are climatic / hydrologic conditions on the site typical for this time of year? Yes No (If no, explain in Remarks.)
 Are Vegetation , Soil , or Hydrology significantly disturbed? Are "Normal Circumstances" present? Yes No
 Are Vegetation , Soil , or Hydrology naturally problematic? (If needed, explain any answers in Remarks.)

SUMMARY OF FINDINGS – Attach site map showing sampling point locations, transects, important features, etc.

Hydrophytic Vegetation Present? Yes <input type="checkbox"/> No <input checked="" type="checkbox"/> Hydric Soil Present? Yes <input type="checkbox"/> No <input checked="" type="checkbox"/> Wetland Hydrology Present? Yes <input checked="" type="checkbox"/> No <input type="checkbox"/>	Is the Sampled Area within a Wetland? Yes <input type="checkbox"/> No <input checked="" type="checkbox"/>
Remarks: Sampling point is located within a drainage ditch that was constructed on uplands before 1971 to manage storm waters from the operations of the quarry.	

VEGETATION – Use scientific names of plants.

Stratum	Absolute % Cover	Dominant Species?	Indicator Status	Worksheet
<u>Tree Stratum</u> (Plot size: <u>30 feet radius</u>)				Dominance Test worksheet: Number of Dominant Species That Are OBL, FACW, or FAC: <u>N/A</u> (A) Total Number of Dominant Species Across All Strata: _____ (B) Percent of Dominant Species That Are OBL, FACW, or FAC: _____ (A/B)
1. <u>N/A</u>				
2. _____				
3. _____				
4. _____				
_____ = Total Cover				Prevalence Index worksheet: Total % Cover of: _____ Multiply by: _____ OBL species <u>N/A</u> x 1 = _____ FACW species _____ x 2 = _____ FAC species _____ x 3 = _____ FACU species _____ x 4 = _____ UPL species _____ x 5 = _____ Column Totals: _____ (A) _____ (B) Prevalence Index = B/A = _____
<u>Sapling/Shrub Stratum</u> (Plot size: <u>15 feet radius</u>)				
1. <u>N/A</u>				
2. _____				
3. _____				
_____ = Total Cover				
<u>Herb Stratum</u> (Plot size: <u>5 feet radius</u>)				Hydrophytic Vegetation Indicators: <input type="checkbox"/> Rapid Test for Hydrophytic Vegetation <input type="checkbox"/> Dominance Test is >50% <input type="checkbox"/> Prevalence Index is ≤3.0 ¹ <input type="checkbox"/> Problematic Hydrophytic Vegetation ¹ (Explain) ¹ Indicators of hydric soil and wetland hydrology must be present, unless disturbed or problematic.
1. <u>N/A</u>				
2. _____				
3. _____				
4. _____				
5. _____				
6. _____				
7. _____				
_____ = Total Cover				
<u>Woody Vine Stratum</u> (Plot size: <u>30 feet radius</u>)				Hydrophytic Vegetation Present? Yes <input type="checkbox"/> No <input checked="" type="checkbox"/>
1. <u>N/A</u>				
2. _____				
3. _____				
_____ = Total Cover				

Remarks:

The 2016 Wetland Plant List was used to determine indicator status.

SOIL

Sampling Point: EC-17

Profile Description: (Describe to the depth needed to document the indicator or confirm the absence of indicators.)

Depth (inches)	Matrix		Redox Features				Texture	Remarks
	Color (moist)	%	Color (moist)	%	Type ¹	Loc ²		

¹Type: C=Concentration, D=Depletion, RM=Reduced Matrix, CS=Covered or Coated Sand Grains. ²Location: PL=Pore Lining, M=Matrix.

Hydric Soil Indicators:

- Histosol (A1)
- Histic Epipedon (A2)
- Black Histic (A3)
- Hydrogen Sulfide (A4)
- Organic Bodies (A6)
- 5 cm Mucky Mineral (A7)
- Muck Presence (A8)
- Depleted Below Dark Surface (A11)
- Thick Dark Surface (A12)
- Sandy Gleyed Matrix (S4)
- Sandy Redox (S5)
- Stripped Matrix (S6)
- Dark Surface (S7)
- Loamy Gleyed Matrix (F2)
- Depleted Matrix (F3)
- Redox Dark Surface (F6)
- Depleted Dark Surface (F7)
- Redox Depressions (F8)

Indicators for Problematic Hydric Soils³:

- Stratified Layers (A5)
- Very Shallow Dark Surface (TF12)
- Other (Explain in Remarks)

³Indicators of hydrophytic vegetation and wetland hydrology must be present, unless disturbed or problematic.

Restrictive Layer (if observed):

Type: N/A
 Depth (inches): N/A

Hydric Soil Present? Yes No

Remarks:

Sampling point is located within a drainage ditch.

HYDROLOGY

Wetland Hydrology Indicators:

Primary Indicators (minimum of one required; check all that apply)

- Surface Water (A1)
- High Water Table (A2)
- Saturation (A3)
- Water Marks (B1)
- Sediment Deposits (B2)
- Drift Deposits (B3)
- Algal Mat or Crust (B4)
- Iron Deposits (B5)
- Inundation Visible on Aerial Imagery (B7)
- Water-Stained Leaves (B9)
- Aquatic Fauna (B13)
- Hydrogen Sulfide Odor (C1)
- Oxidized Rhizospheres on Living Roots (C3)
- Presence of Reduced Iron (C4)
- Recent Iron Reduction in Tilled Soils (C6)
- Thin Muck Surface (C7)
- Fiddler Crab Burrows (C10)
- Other (Explain in Remarks)

Secondary Indicators (minimum of two required)

- Surface Soil Cracks (B6)
- Sparsely Vegetated Concave Surface (B8)
- Drainage Patterns (B10)
- Dry-Season Water Table (C2)
- Saturation Visible on Aerial Imagery (C9)
- Geomorphic Position (D2)
- Shallow Aquitard (D3)
- FAC-Neutral Test (D5)

Field Observations:

Surface Water Present? Yes No Depth (inches): 24
 Water Table Present? Yes No Depth (inches): _____
 Saturation Present? (includes capillary fringe) Yes No Depth (inches): _____

Wetland Hydrology Present? Yes No

Describe Recorded Data (stream gauge, monitoring well, aerial photos, previous inspections), if available:

Remarks:

Sampling point is located within a drainage ditch.

Appendix 12a

Advisory Base Flood Elevation (ABFE) Map

Econo Energy Project

Project ID: IPGM-00375

Address: State Road PR-3, Int. PR 9959, Km. 15.21 Bo. Canovanillas, Canóvanas, PR. 00729

Coordinates: 18.373613° -65.906549°

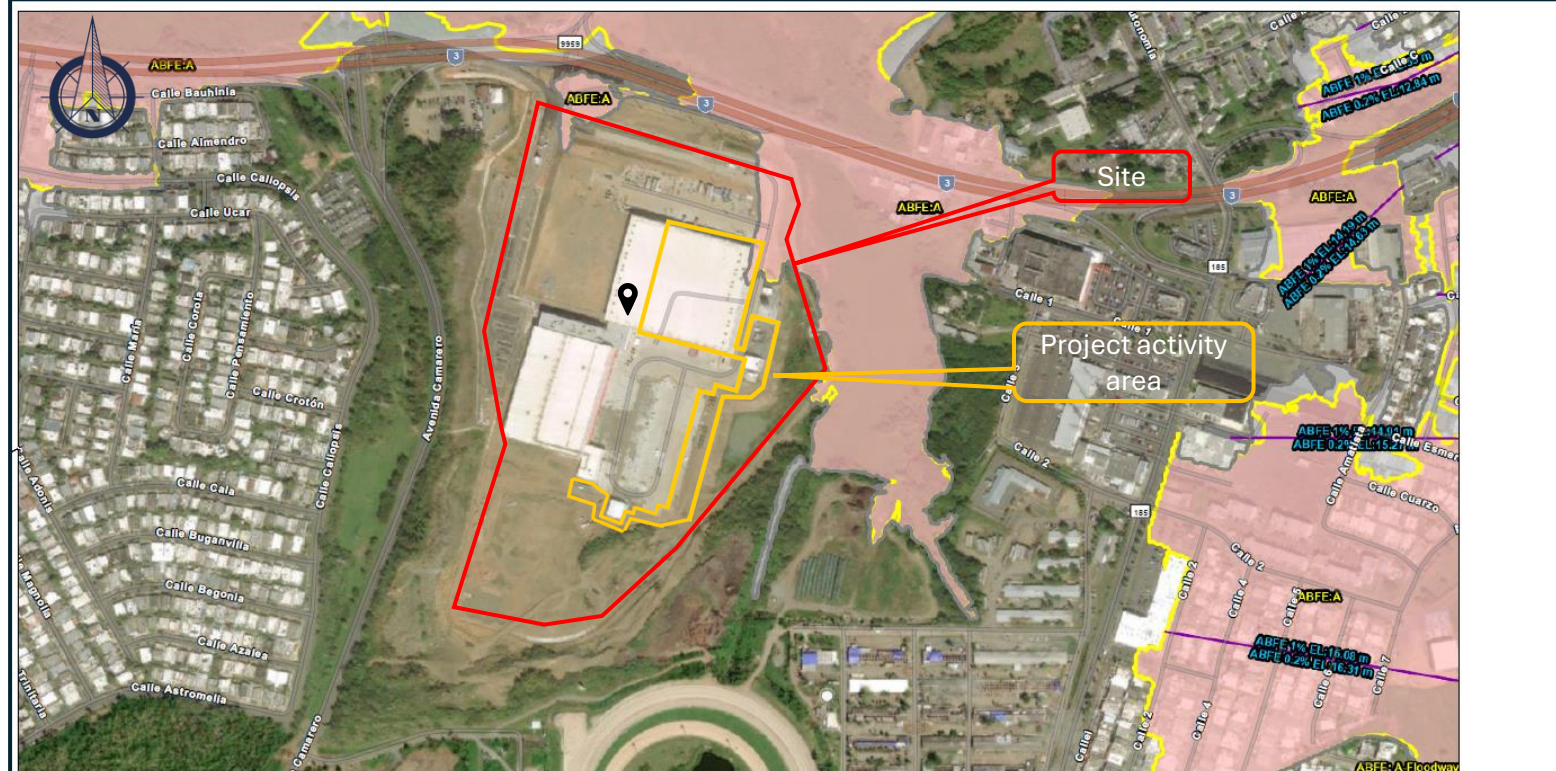

5/19/2024, 5:06:32 PM

Flood Hazard Area (zoom in to make visible) Flood Hazard Extent

- A
- 0.2% Annual Chance Flood Zone
- A-Floodway
- Zone/BFE Boundary
- 1% Annual Chance Flood
- 0.2% Annual Chance Flood
- Advisory Base Flood Elevation (zoom in to make visible)

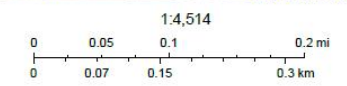

FEMA, Source: Esri, Maxar, Earthstar Geographics, and the GIS User Community, Esri Community Maps Contributors, Esri, TomTom, Garmin, Foursquare, SafeGraph, GeoTechnologies, Inc, METINASA, USGS, NPS, US Census Bureau, USFWS

ArcGIS Web AppBuilder
FEMA | Source: Esri, Maxar, Earthstar Geographics, and the GIS User Community | Esri Community Maps Contributors, Esri, TomTom, Garmin, Foursquare, SafeGraph, GeoTechnologies, Inc, METINASA, USGS, NPS, US Census Bureau, USFWS |

Appendix 12b Preliminary FIRM (PFIRM) Map

Econo Energy Project

Project ID: IPGM-00375

Address: State Road PR-3, Int. PR 9959, Km. 15.21 Bo.

Canovanillas, Canóvanas, PR. 00729

Coordinates: 18.373613° -65.906549°

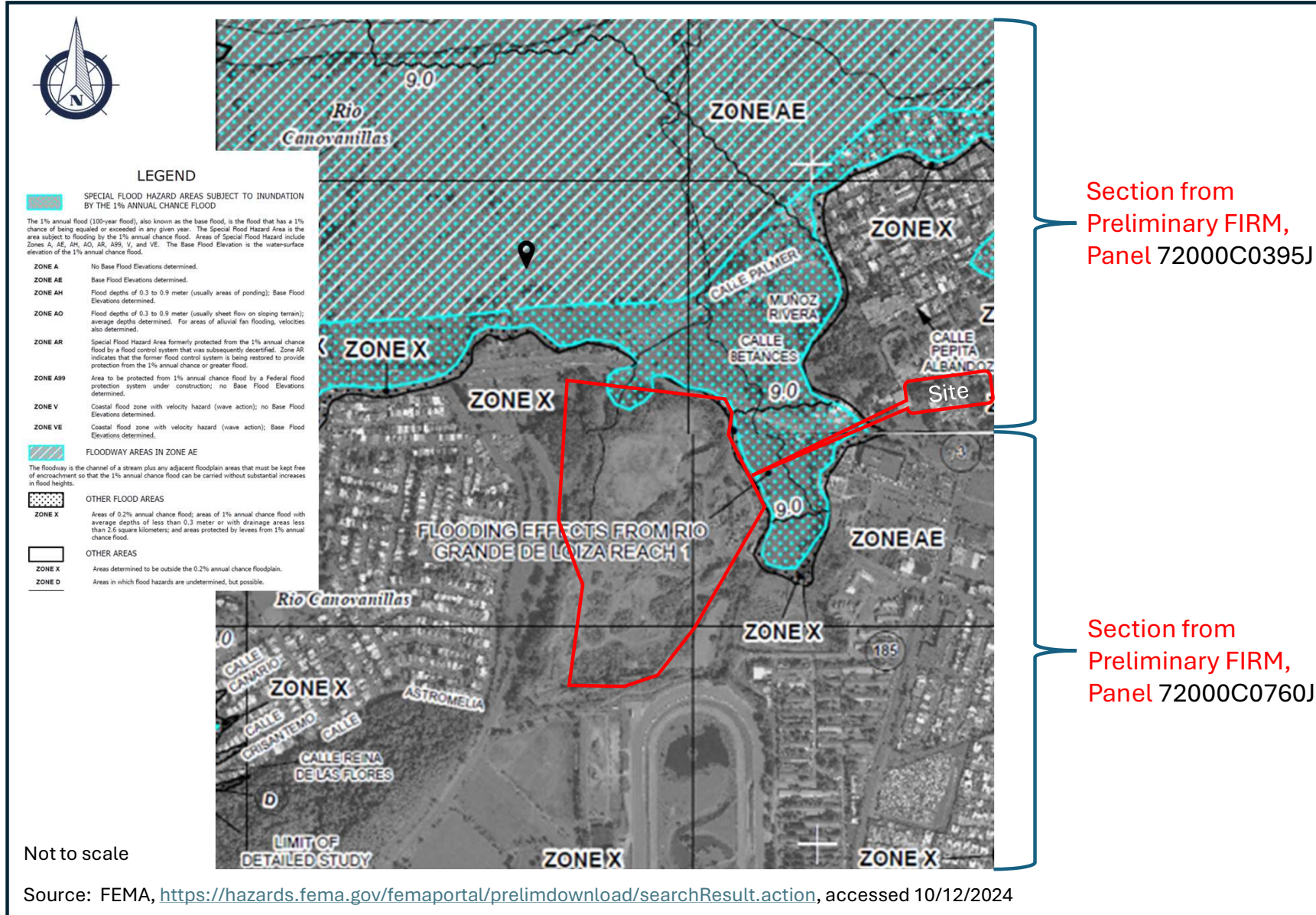

Section from Preliminary FIRM, Panel 72000C0395J

Section from Preliminary FIRM, Panel 72000C0760J

Not to scale

Source: FEMA, <https://hazards.fema.gov/femaportal/prelimdownload/searchResult.action>, accessed 10/12/2024

Appendix 13

SHPO Consultation documents



GOVERNMENT OF PUERTO RICO

STATE HISTORIC PRESERVATION OFFICE

Executive Director | Carlos A. Rubio Cancela | carubio@prshpo.pr.gov

Friday, October 18, 2024

Lauren B Poche

269 Avenida Ponce de León, San Juan, PR, 00917

SHPO-CF-10-01-24-04 IPGM-00375 (Canóvanas), Supermercados Econo - Energy Project

Dear Ms. Poche,

Our Office has received and reviewed the above referenced project in accordance with 54 USC 306108 (commonly known as Section 106 of the National Historic Preservation Act, as amended) and 36 CFR Part 800: Protection of Historic Properties from the Advisory Council on Historic Preservation. The State Historic Preservation Officer (SHPO) is to advise and assist federal agencies and other responsible entities when identifying historic properties, assessing effects upon them, and considering alternatives to avoid or reduce the project's effects.

Our records support your finding of no historic properties affected within the project's area of potential effects.

Please note that should the Agency discover other historic properties at any point during project implementation, you should notify the SHPO immediately. If you have any questions concerning our comments, do not hesitate to contact our Office.

Sincerely,

Carlos A. Rubio Cancela

State Historic Preservation Officer

CARC/GMO/EVR



Cuartel de Ballajá (Tercer Piso), Calle Norzagaray, Esq. Beneficencia, Viejo San Juan, PR 00901 | PO Box 9023935, San Juan, PR 00902-3935



GOVERNMENT OF PUERTO RICO
DEPARTMENT OF HOUSING

April 30, 2024

Arch. Carlos A. Rubio Cancela

Executive Director

Puerto Rico State Historic Preservation Office

Cuartel de Ballajá, Third Floor

San Juan, Puerto Rico 00901

Re: Authorization to Submit Documents for Consultation

Dear Arch. Rubio Cancela,

The U.S. Department of Housing (HUD) approved the allocations of Community Development Block Grant (CDBG-DR) funds on February 9, 2018. It also approved the allocation of Community Development Block Grant Mitigation (CDBG-MIT) funds on January 27, 2020. The purpose of these allocations is to address unsatisfied needs as a result of Hurricanes Irma and Maria in September 2017; and to carry out strategic and high-impact activities to mitigate disaster risks and reduce future losses.

To comply with the environmental requirements established by HUD, the Department of Housing of Puerto Rico (PRDOH) contracted Horne Federal LLC to provide environmental review services, among others, that will support the objectives of the agenda for both CDBG-DR and CDBG -MIT Programs.

To expedite the processes, Horne Federal LLC, is authorized to submit to the State Historic Preservation Officer, documentation of projects related to both the CDBG-DR and CDBG-MIT on behalf of PRDOH.

Cordially,

Aldo A. Rivera Vázquez, PE

Director

Division of Environmental Permitting and Compliance

Office of Disaster Recovery

10/1/2024

Carlos A. Rubio Cancela
State Historic Preservation Officer
Puerto Rico State Historic Preservation Office
Cuartel de Ballajá (Tercer Piso)
San Juan, PR 00902-3935

Puerto Rico Department of Housing (PRDOH), CDBG-MIT Economic Development Investment Portfolio for Growth – Lifeline Mitigation

Section 106 NHPA Effect Determination Submittal for Case IPGM-00375: Supermercados Econo - Energy Project Project, Canóvanas, Puerto Rico – No Historic Properties Affected

Dear Architect Rubio Cancela,

The Puerto Rico Department Of Housing (PRDOH) launched the Economic Development Investment Portfolio for Growth – Lifeline Mitigation Program (IPG-MIT) with the objective of targeting economic development funding for privately owned lifeline infrastructure to support Risk-Based Mitigation Needs. The IPG-MIT Program, with an allocation of \$628,816,696 in mitigation funds from CDBG-MIT, is intended for projects focused on private investment in lifeline infrastructure to increase stability and/or expansion of lifeline services. As an extension of the IPG financed with CDBG-DR funds, this mitigation-focused Program is intended to fund large-scale reconstruction projects that are transformative in nature, substantially impacting the economic sector and workforce. To ensure compliance with HUD's environmental requirements, the PRDOH contracted Horne Federal, LLC (HORNE) to provide environmental records review services for their CDBG-MIT Programs.

On behalf of PRDOH, HORNE is submitting documentation for the proposed Supermercados Econo - Energy Project. The Supermercados Econo, Inc. is proposing the construction of a High-Efficiency Hybrid Power Plant for the Supermercados Econo Distribution Center at 18.374968, -65.907350, in Canóvanas, Puerto Rico. A hybrid energy system combines one or more renewable with non-renewable energy sources, which may be connected to the electric grid or operate off the grid in some instances. The proposed power configuration for the Econo Distribution Center includes approximately 2,750 photovoltaic panels to generate clean solar energy, combined with a generator powered by natural gas and a Battery Energy Storage System (BESS) to store energy generated from both sources. The distribution center currently has emergency-powered generator units operating with diesel fuel. The installation of the new system requires the construction of concrete pads and

underground pipes to connect the LNG tank, JGC420 Generator, BESS, Electrical Control Room, and TR 3 MVA to the cold storage facility. To take advantage of the heat, concrete foundations for the water tank, the evaporator and the cooling tower will be needed. Underground water pipes from the existing cooling towers will be connected to the evaporator system and from the evaporator to the towers for recycling water. The Supermercados Econo Distribution Center is a modern construction in terrain previously used as a quarry until c.2006. The terrain has been impacted by heavy machinery and quarrying activities. The full scope of the project, which includes mapping, photographs, and construction plans, is described in the submitted documentation.

Based on the provided documentation, the Program requests a concurrence with a determination that **no historic properties affected** are appropriate for this undertaking.

Please contact me with any questions or concerns by email at lauren.poche@horne.com or phone at 225-405-7676.

Kindest regards,



Lauren Bair Poche. M.A.

Architectural Historian, EHP Senior Manager

LBP/JCO

Attachments

PR-IPGM-00375

**Supermercados Econo - Energy Project
Project**

Canóvanas, Puerto Rico

Section 106 Effect Determination Form

PUERTO RICO 2017 DISASTER RECOVERY, CDBG-DR PROGRAM Investment Portfolio for Growth Program (IPG-DR and IPG-MIT) Section 106 NHPA Effect Determination	 GOVERNMENT OF PUERTO RICO DEPARTMENT OF HOUSING
Subrecipient: Supermercados Econo, Inc.	
Program ID: PR-IPGM-00375	
Project Name: Econo Energy Project	

Project Location: State Road PR-3, Int. PR 9959, Km. 15.21, Bo. Canovanillas, Canóvanas, PR 00729	
Project Coordinates: 18.373613, -65.906549	
TPID (Número de Catastro): 117-000-003-01-000	
Type of Undertaking: <input type="checkbox"/> Substantial Repair/Improvements <input checked="" type="checkbox"/> New Construction	
Construction Date (AH. Est.): 2021	Property Size (m²): 1618.74

SOI-Qualified Archaeologist: Jesus E. Vega, Ph.D.
Date Reviewed: July 12, 2024; Revised September 24, 2024

In compliance with Section 106 of the National Historic Preservation Act (NHPA), the Program is responsible for identifying historic properties listed in the NRHP and any properties not listed that would be considered eligible for listing that are located within the geographic area of potential effects (APE) of the proposed project and assessing the potential effects of its undertakings on these historic properties.

Project Description (Undertaking)

The proposed undertaking is the construction of a High-Efficiency Hybrid Power Plant for Supermercados Econo Distribution Center at 18.374968, -65.907350, in Canóvanas, Puerto Rico. A hybrid energy system combines one or more renewable with non-renewable energy sources, which may be connected to the electric grid, or operate off the grid in some instances. For the Econo Distribution Center, the proposed power configuration includes approximately 2,750 photovoltaic panels to generate clean, solar energy, combined with a generator powered by natural gas, and a Battery Energy Storage System (BESS) to store energy generated from both sources (**Figure 1**).

The project includes a thermal recovery system to reduce water consumption and environmental impact. The heat generated by the engine will be delivered to an evaporator for treating the wastewater from utilities. This process will generate distilled water to be reused in the cooling tower, and salt waste in a drying bed, to be discharged at the landfill, or reused as fertilizer.

The High-Efficiency Hybrid Power Plant will provide stability to the energy needs of the Econo Distribution Center, currently supplied by LUMA Energy, responsible for power distribution and transmission in Puerto Rico. The instability of LUMA Energy poses a risk for the food requiring a controlled temperature. Currently, the facility has two (2),

PUERTO RICO 2017 DISASTER RECOVERY, CDBG-DR PROGRAM Investment Portfolio for Growth Program (IPG-DR and IPG-MIT) Section 106 NHPA Effect Determination	 GOVERNMENT OF PUERTO RICO DEPARTMENT OF HOUSING
Subrecipient: Supermercados Econo, Inc.	
Program ID: PR-IPGM-00375	
Project Name: Econo Energy Project	

emergency-power generator units, operating with diesel fuel when the power goes out or becomes unstable, with a nominal capacity of 2,500 kWh each. However, these units cannot be used for prolonged periods of time. The proposed activity will add power generation capacity by means of a combined photovoltaic system, a power generator that runs on natural gas, and BESS in addition to the existing emergency-power generator units that will remain at the site and will continue to be used as needed. The proposed new energy supply will be an additional source of electricity during emergency and non-emergency periods.

The proposed Hybrid Power Plant will provide efficient and reliable energy to ensure continuous, year-round operation, reducing the risk of damaged goods, and minimizing the threat to food security and distribution in Puerto Rico during a catastrophic event. Supermercados Econo is among the largest food suppliers on the island, with the Econo Distribution Center in Canóvanas operating as the main distribution center for its supermarket chain. The proposed undertaking will provide electrical autonomy to the facility in the event of catastrophic events affecting the island-wide power supply and distribution.

The Hybrid Power Plant will supply power solely to the cold storage facility, not serving any offsite structures or other facilities on site. The installation of the new system requires the construction of concrete pads and underground pipes to connect the LNG tank, JGC420 Generator, BESS, Electrical Control Room and TR 3 MVA to the cold storage facility. To take advantage of the heat, it will be necessary to build concrete foundations for the water tank, the evaporator and the cooling tower. Underground water pipes from the existing cooling towers will be connected to the evaporator system, and from the evaporator to the towers for recycling water (**Figure 2**). The proposed project does not increase the capacity of the structure, nor its occupancy. Based on the installation of pads, trenching for pipes running under ground, and increased air emissions, it has been determined that the project requires an Environmental Assessment for compliance with 24 CFR Part 58.

The Supermercados Econo Distribution Center is a modern construction in terrain previously used until as a quarry, until c.2006, impacted by heavy machinery, producing boulders and gravel for the construction industry.

Subrecipient: Supermercados Econo, Inc.

Program ID: PR-IPGM-00375

Project Name: Econo Energy Project

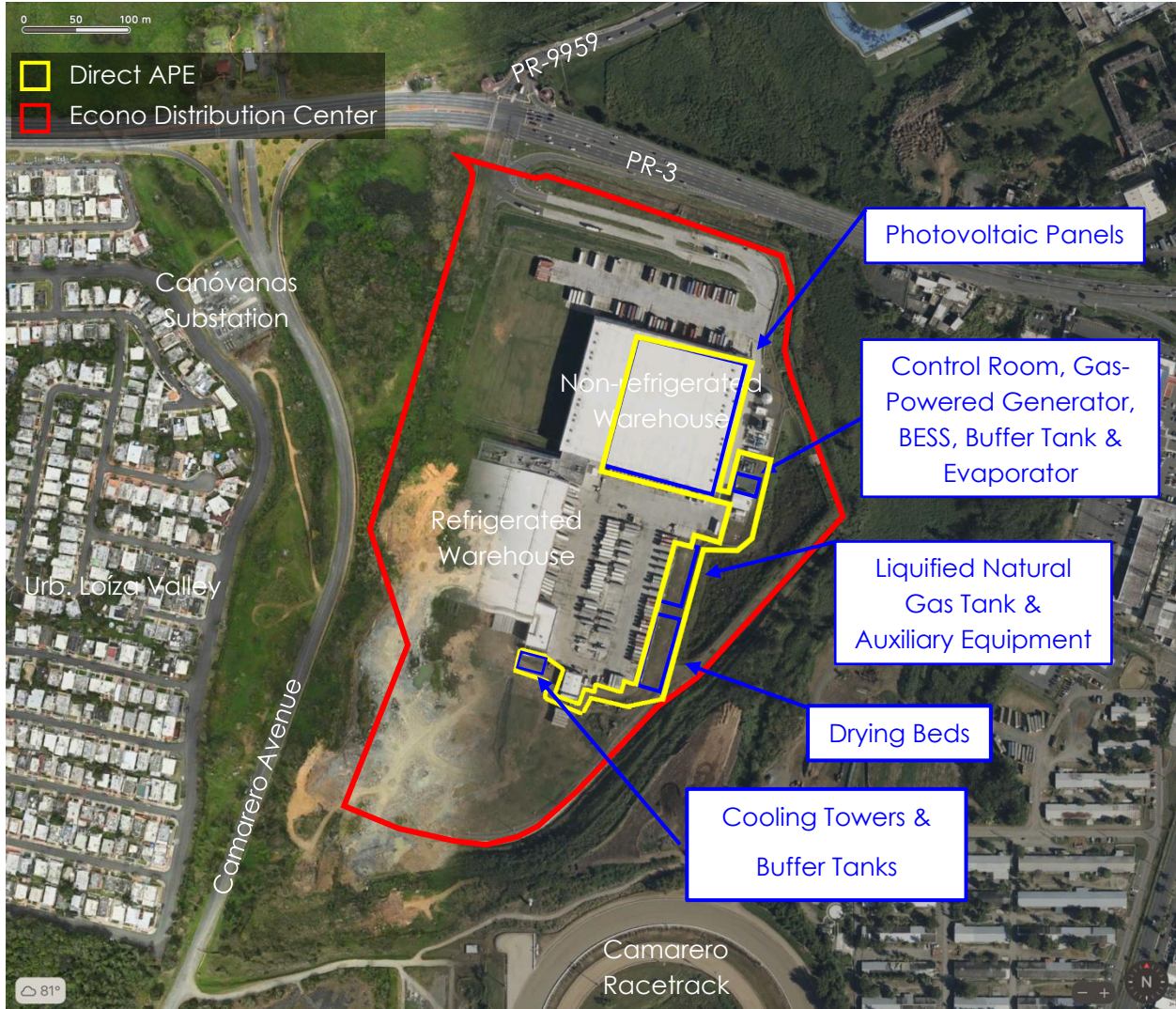

Figure 1. Direct APE overlay identifying proposed project actions within the boundaries of the Econo Distribution Center, located in the Municipality of Canóvanas (Source: Apple Maps, <https://www.apple.com/maps/>).

Subrecipient: Supermercados Econo, Inc.

Program ID: PR-IPGM-00375

Project Name: Econo Energy Project

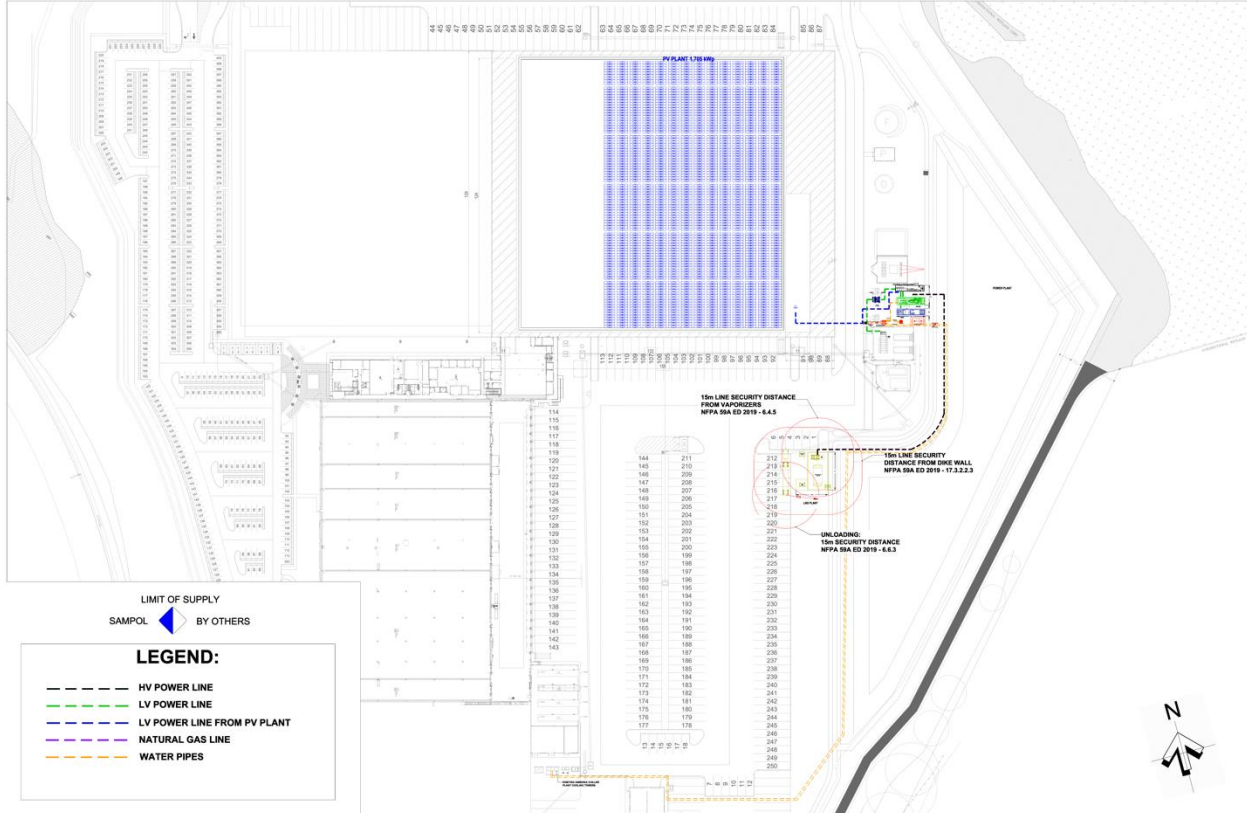



Figure 2. Master layout (drawing #ECO-GEN-02-01-E14) of the proposed high-efficiency hybrid power plant for the Econo Distribution Center, 1:2,000 scale (Source: SAMPOL, 2024).

PUERTO RICO 2017 DISASTER RECOVERY, CDBG-DR PROGRAM Investment Portfolio for Growth Program (IPG-DR and IPG-MIT) Section 106 NHPA Effect Determination	 GOVERNMENT OF PUERTO RICO DEPARTMENT OF HOUSING
Subrecipient: Supermercados Econo, Inc.	
Program ID: PR-IPGM-00375	
Project Name: Econo Energy Project	

Area of Potential Effects

As defined in 36 CFR §800.16(d), the area of potential effects (APE) is the geographic area or areas within which an undertaking may directly or indirectly cause changes in the character or use of historic properties if any such properties exist. Based on this definition and the nature and scope of the Undertaking, the Program has determined that the direct APE for this project is approximately two-thirds of the rooftop of the non-refrigerated groceries warehouse, the generator room, and a portion of the exterior grounds along the eastern border of the facility, extending southward. The direct APE approximately measures 340.75 meters long (north to south) and 147.05 meters wide (east to west), including the rooftop of the non-refrigerated warehouse, which totals an area of 20,628.58 square meters. However, excluding the rooftop of the non-refrigerated warehouse and only measuring areas with ground disturbance, the total area of the direct APE equals 17,652.81 1,640 square meters. The viewshed of the project or visual APE consists of State Road PR-3 to the north, which is only visible from the rooftop of the non-refrigerated warehouse, the truck loading zones for both refrigerated and non-refrigerated warehouses to the west, the eastern border of the Econo Distribution Center bordered by the banks of Bocaforma Creek to the east, and Camarero Racetrack, a horse racing venue, to the south.

The ground impact to the direct APE includes the JGC420 Generator (48.31 m²), the new battery system (45.52 m²), the dry cooler (15.79 m²), CW pumps (0.84 m²), HT pumps (0.84 m²), electrical container (45.52 m²), buffer tank (1.86 m²), evaporator (5.57 m²), blowdown buffer tank (29.73 m²), conditioned water buffer tank (14.86 m²), three drying beds (148.64 m²), and LNG regasification plant (195.10 m²), for a total area of 552.59 m². The estimated depth of impact of concrete bases for these separate constructions is estimated in one foot. The visual or indirect APE is limited by low hill and woodland terrain. Even the nearby racetrack is beyond the visual APE.

Historic Context

The history of Canóvanas begins with Loíza, a densely populated Taíno region centered on the Río Grande de Loíza. The name of Canóvanas is derived from the Taíno *cacique* or chief Canóvanax, reported by Cayetano Coll y Toste as serving or *encomendado* to the Spanish *conquistador* Miguel Díaz, who married the daughter of a Haitian *cacique* and was eventually appointed interim governor of Puerto Rico in 1512.

PUERTO RICO 2017 DISASTER RECOVERY, CDBG-DR PROGRAM Investment Portfolio for Growth Program (IPG-DR and IPG-MIT) Section 106 NHPA Effect Determination	
Subrecipient: Supermercados Econo, Inc.	
Program ID: PR-IPGM-00375	
Project Name: Econo Energy Project	

In the early 16th century, Loíza became a colonial Spanish agrarian region, with Canóvanas eventually developing as an inland barrio or ward of Loíza. The early Spanish settlement of Loíza was called Loíza Aldea, located near the north coast, immediately east of the Río Grande de Loíza, where the oldest part of town is still located.

A Spanish topographic map of 1888, published by the *Centro Geográfico del Ejército*, depicts the small town of Canóvanas at its present-day location by State Road PR-3, between the towns of Carolina and Loíza (**Figure 3**). The location of Loíza was advantageous in the 16th century, a short sail away from the capital city of San Juan since 1521. However, by the early 20th century, the municipal capital of Loíza was too far away from the new sugar centrals rising along State Road PR-3, also known as the Military Road from San Juan to Fajardo.

In 1902, Loíza became a part of the Municipality of Río Grande, including Canóvanas. In 1909, Loíza regained its municipal independence. That same year, the Municipal Council of Loíza decided to relocate the city hall and town center inland, to the town of Canóvanas, including twenty cuerdas by State Road PR-3, close to the sugar centrals generating municipal revenues. USGS topographic maps for the Carolina Quadrangle, dating from 1946 and 1959 identify the town of Canóvanas as Loíza (**Figure 6** and **Figure 7**). In 1970, Canóvanas achieved its municipal independence by Law #149, following an official referendum celebrated that same year.

Identification of Historic Properties - Archaeology

Existing information on previously identified historic properties has been reviewed to determine if any such properties are located within the APE of this undertaking. The review of this existing information, by a Program contracted Historic Preservation Specialist meeting the Secretary of the Interior's Professional Qualification Standards (36 CFR Part 61), shows that the project area is within a quarter-mile radius of zero (0) recorded archaeological sites and NRHP-listed/eligible historic properties.

The Municipality of Canóvanas includes over thirty-eight (38) historic properties reported in state files of the Puerto Rico State Historic Preservation Office (PRSHPO), and in the Archaeology Division of the *Instituto de Cultura Puertorriqueña* (ICP). Known historic properties in Canóvanas range from TCN-12 (CW0100009), a rock shelter with petroglyphs, and TCN-13 (CW0100010), petroglyphs at the Río Canovanillas, to Ingenio San Luis (CW0200006), an 18th century sugar mill with brick ruins. Canóvanas also has one

PUERTO RICO 2017 DISASTER RECOVERY, CDBG-DR PROGRAM Investment Portfolio for Growth Program (IPG-DR and IPG-MIT) Section 106 NHPA Effect Determination	 GOVERNMENT OF PUERTO RICO DEPARTMENT OF HOUSING
Subrecipient: Supermercados Econo, Inc.	
Program ID: PR-IPGM-00375	
Project Name: Econo Energy Project	

historic property listed in the National Register of Historic Places, Villarán Bridge (CW0200005), an iron bridge built in 1892, also called *Puente de Canóvanas*, nominated to the NRHP in 1995, and currently used as a pedestrian bridge. None of these historic properties are located within the direct APE, or within a quarter mile radius.

There are no reported historic properties within the direct APE, where the High-Efficiency Hybrid Power Plant is to be installed, or within the boundaries of the Econo Distribution Center. Additionally, there are no reported historic properties of any era within a quarter-mile radius of the direct APE. Similarly, the Canóvanas Traditional Urban Center is approximately 0.35 miles northeast (**Figure 6**).

Table 1. Cultural Resource Studies Conducted Within Quarter-Mile Radius of Project Area

A.	Title: Phase 1A-1B, Proyecto Residencial y Comercial El Nuevo Comandante, Carr. PR-3, Barrio Pueblo, Canóvanas		
	SHPO ID: N/A	ICP ID: N/A	NRHP ID: N/A
	Author: Marisol Martínez Garayalde		Year: 2006
	Results: Negative		Distance: 0.00 mi
B.	Title: Phase 1A-1B, Improvement to the Water Supply System 5,100 m Linear 24" Diameter Raw Water Line		
	SHPO ID: 11-25-97-08	ICP ID: N/A	NRHP ID: N/A
	Author: Antonio Daubón Vidal		Year: 1994
	Results: Negative		Distance: 0.10 mi NE
C.	Title: Phase 1A-1B, Coliseo Municipal Ramón Ramos		
	SHPO ID: 10-28-94-02	ICP ID:	NRHP ID: N/A
	Author: Juan González Colón		Year: 1997
	Results: Negative		Distance: 0.22 mi NE

In her 2002 regional archaeological survey of Canóvanas, Marisol Meléndez Maiz divided the municipality in ecological zones. The terrain encompassing the future Econo Distribution Center was classified within Zone Ew, southwest of the Canóvanas Traditional Urban Center. Ew was classified a mostly hill and alluvial terrain with elevations from 10 to 25 meters, bound by the Canovanillas River to the west, and Bocaforma Creek to the east, both of them being tributaries of the Río Grande de Loíza.

PUERTO RICO 2017 DISASTER RECOVERY, CDBG-DR PROGRAM Investment Portfolio for Growth Program (IPG-DR and IPG-MIT) Section 106 NHPA Effect Determination	 GOVERNMENT OF PUERTO RICO DEPARTMENT OF HOUSING
Subrecipient: Supermercados Econo, Inc.	
Program ID: PR-IPGM-00375	
Project Name: Econo Energy Project	

Meléndez Maíz considered the alluvial soil along the Canovanillas River, the Toa series of deep, well-drained, moderately permeable soils on river flood plains, as potentially sensitive to prehistoric sites, based on similar soils with archaeological sites in Río Grande and Trujillo Alto. However, no historic properties of any era were identified or discovered by Meléndez Maíz within Zone Ew.

Prior to construction of the Econo Distribution Center in 2019, the direct APE was a quarry that began to be exploited in the 1960s. This quarry is first depicted in the 1969 USGS topographic map for the Carolina Quadrangle, which includes most of the direct APE, with a south segment within the USGS topographic map of the Gurabo Quadrangle, as seen on the 1972 edition of the same USGS topographic map (**Figure 7**).

The quarry encompassing the future direct APE was located 0.05 miles south of State Road PR-3. This terrain is identified in the USGS Geologic Map of the Carolina Quadrangle as thin to thick-bedded, medium gray calcareous mudstone of the Frailes Formation, Leprocomio Mudstone Member (Kfl), dated in the Upper Cretaceous (Monroe 1977). This geologic setting of mudstone hills implies a rocky terrain artificially lowered by the quarry operation, which is not depicted in the USGS topographic maps of Carolina between 1940 and 1947, or any map or aerial photograph prior to the 1960s.

In 2006, Marisol Martínez Garayalde conducted a Phase 1A-1B archaeological survey of the quarry. The proposed undertaking was a mixed residential and commercial project called *El Nuevo Comandante*, named after the hippodrome or racetrack directly south of the quarry, which still exists as the new Camarero Hippodrome. The proposed project of 2006 encompassed 311.334,6 meters. The quarry included the totality of the future Econo Distribution Center, plus additional terrain to the east, reaching Bocaforma Creek as the eastern boundary of the project. The background cultural research, walking inspection and shovel testing by Martínez Garayalde's team did not detect any historic properties within the quarry (**Figure 8**).

The 1959 USGS topographic map depicts an *aljibe* a cistern located on top of a hill, located 0.08 miles south of State Road PR-3, at an elevation of 44 meters (**Figure 5**). It is also labeled on the 1982 USGS topographic map (**Figure 9**). This *aljibe* or cistern is evident in historic aerial photographs of 1937 and 1962 (**Figure 10** and **Figure 11**). This is the only known historic property within a quarter-mile radius of the direct APE. It is at least 87 years old and associated with local agriculture or ranching activity.

PUERTO RICO 2017 DISASTER RECOVERY, CDBG-DR PROGRAM Investment Portfolio for Growth Program (IPG-DR and IPG-MIT) Section 106 NHPA Effect Determination	 GOVERNMENT OF PUERTO RICO DEPARTMENT OF HOUSING
Subrecipient: Supermercados Econo, Inc.	
Program ID: PR-IPGM-00375	
Project Name: Econo Energy Project	

Careful analysis of the aerial photographs and USGS topographic maps against modern satellite images indicates that the *aljibe* was destroyed by quarry operations. This information, plus an old photograph of the quarry and our 2024 field inspection of the Econo Distribution Center, indicates that the leveling of the direct APE and surrounding terrain by quarrying operations reaches 44 meters. Given this drastic anthropogenic impact, and the proposed excavation of concrete pads not exceeding one foot in depth, the potential for detecting intact archaeological sites is zero.

If the *aljibe* or cistern existed today, its ruins would be located almost exactly at the north border of the non-refrigerated warehouse of the Econo Distribution Center. It must be stressed, however, that the historic cistern and the hill where it was located were destroyed by the quarrying operation since the 1960s. The extent of the land transformed by the quarry is evident in a 2002 satellite image provided by Google Earth Pro (**Figure 12**).

The historic property closest to the direct APE is the Casa Jesús T. Piñero, TCN-EH5 (CW0200010), a rural residence built in 1930, occupied by the first Puerto Rican-born governor of Puerto Rico, appointed by the U.S. Government, rather than elected. The Piñero house and museum is adjacent to 19th century brick and masonry ruins identified as TCN-H1 (CW0200009), presumably associated with a sugar hacienda or cattle ranch. Regarding any possible impact from the undertaking, these historic properties are located at the opposite side of State Road PR-3, and beyond a quarter-mile radius of the direct APE.

Subrecipient: Supermercados Econo, Inc.

Program ID: PR-IPGM-00375

Project Name: Econo Energy Project

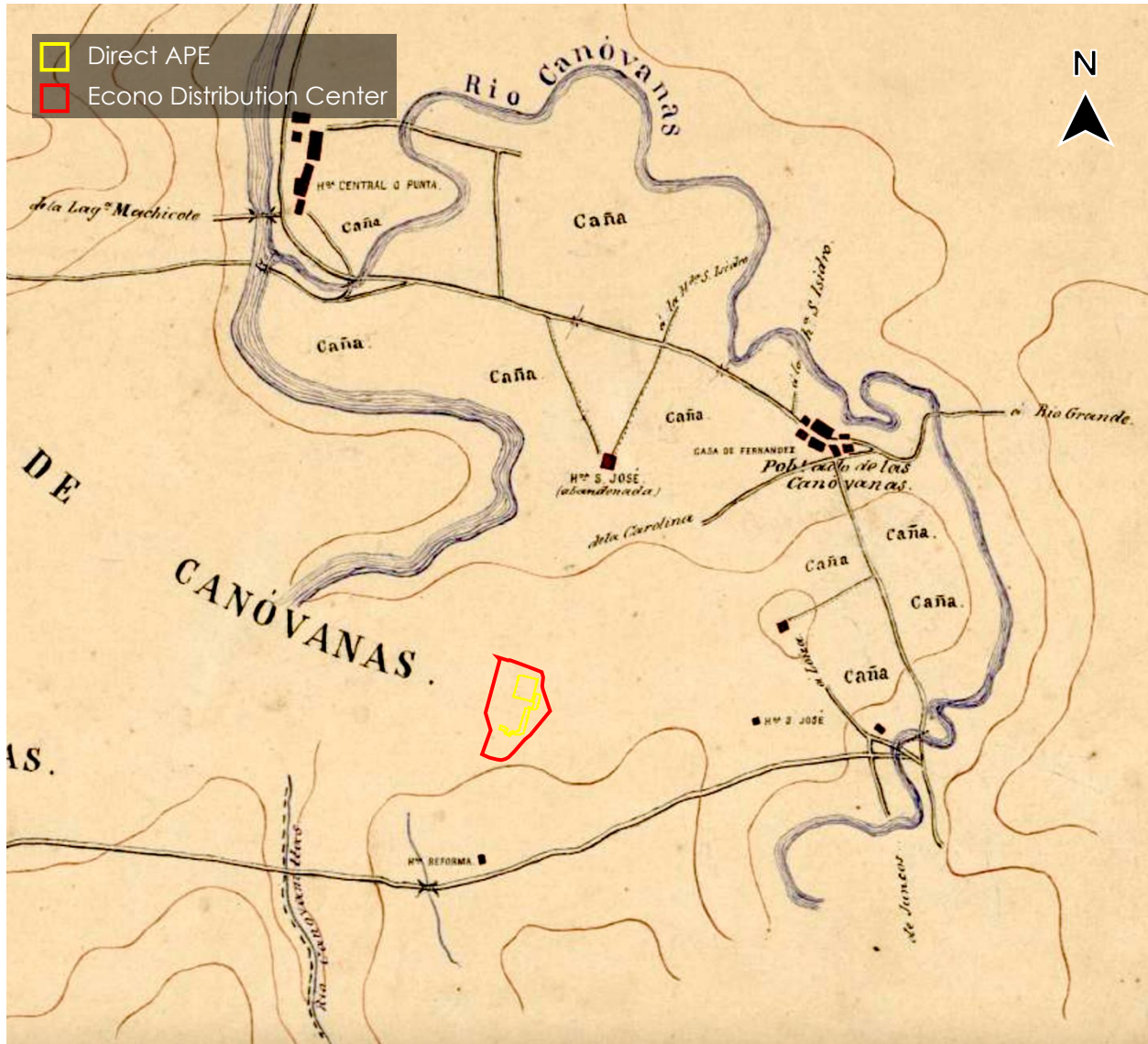

Figure 3. 1888 Spanish topographic itinerary (1:20,000 scale) from Carolina to Loíza prepared by the Centro Geográfico del Ejército (Source: Archivo Nacional Digital, <https://archivonacional.com/PL/1/1/265>).

Subrecipient: Supermercados Econo, Inc.

Program ID: PR-IPGM-00375

Project Name: Econo Energy Project

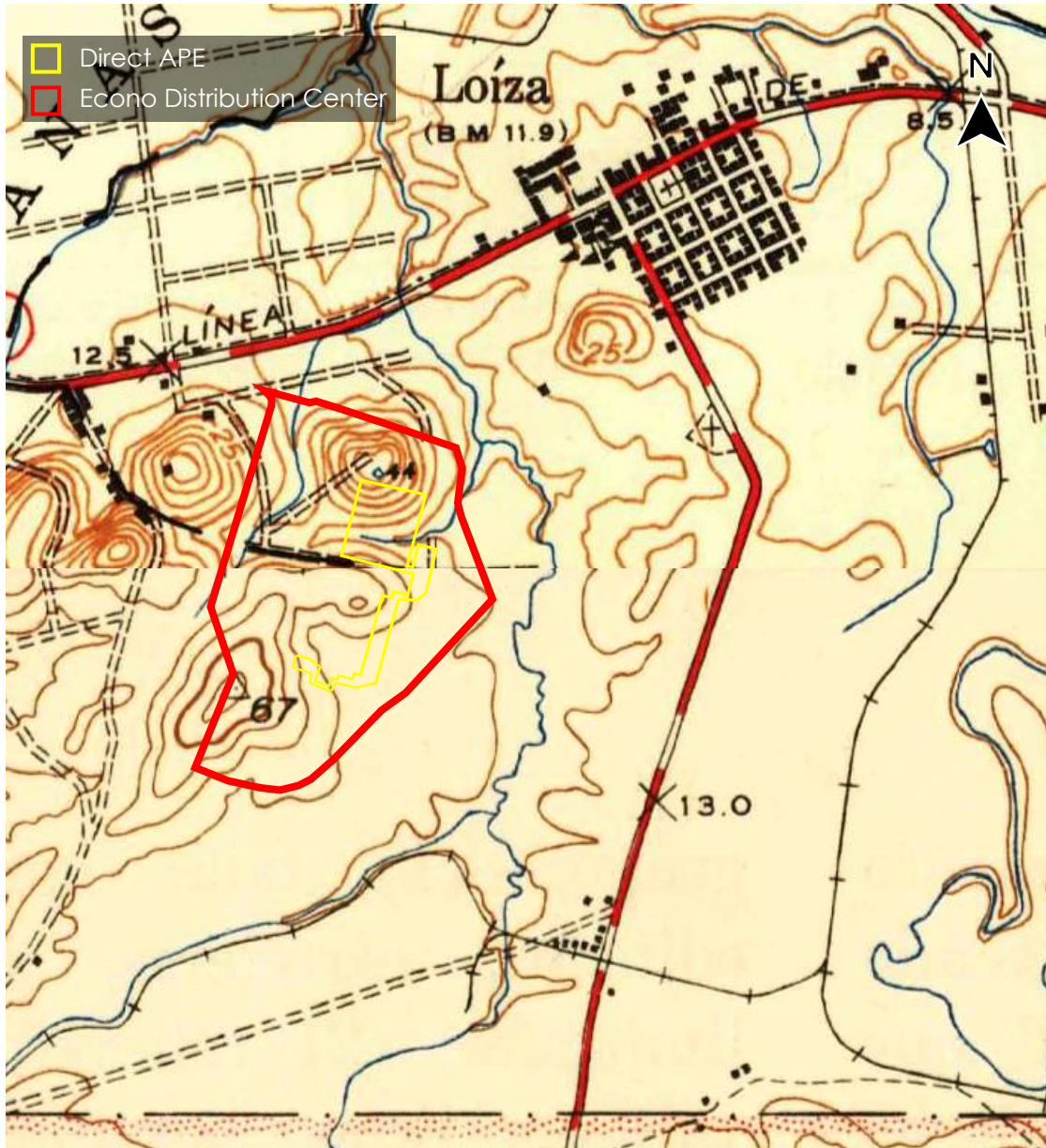

Figure 4. Composite image of 1946-1947 USGS topographic maps (1:30,000 scale) of the Carolina Quadrangle (above) and the Gurabo Quadrangle (below) (Source: USGS topoView, <https://ngmdb.usgs.gov/topoview/>).

Subrecipient: Supermercados Econo, Inc.

Program ID: PR-IPGM-00375

Project Name: Econo Energy Project

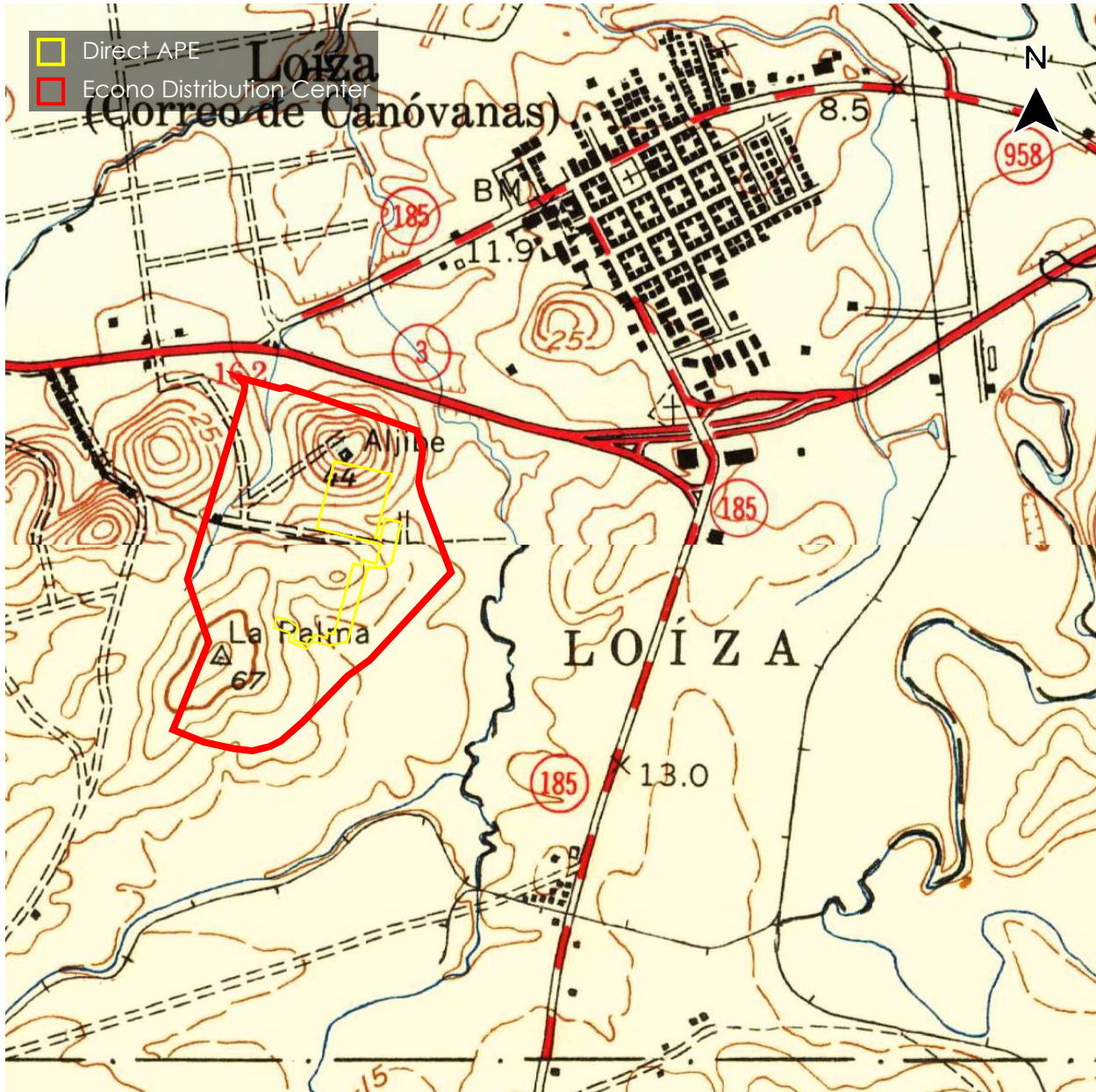

Figure 5. Composite image of 1959 USGS topographic maps (1:20,000 scale) of the Carolina Quadrangle (above) and the Gurabo Quadrangle (below) (Source: USGS topoView, <https://ngmdb.usgs.gov/topoview/>).

Subrecipient: Supermercados Econo, Inc.

Program ID: PR-IPGM-00375

Project Name: Econo Energy Project



Figure 6. Project (Parcel) Location - Canóvanas Traditional Urban Center (Source: State Historic Preservation Office (SHPO); Traditional Urban Center is approximately 0.35 miles northeast (>0.25 miles), <https://www.oech.pr.gov/conservacion-historica>).

Subrecipient: Supermercados Econo, Inc.

Program ID: PR-IPGM-00375

Project Name: Econo Energy Project

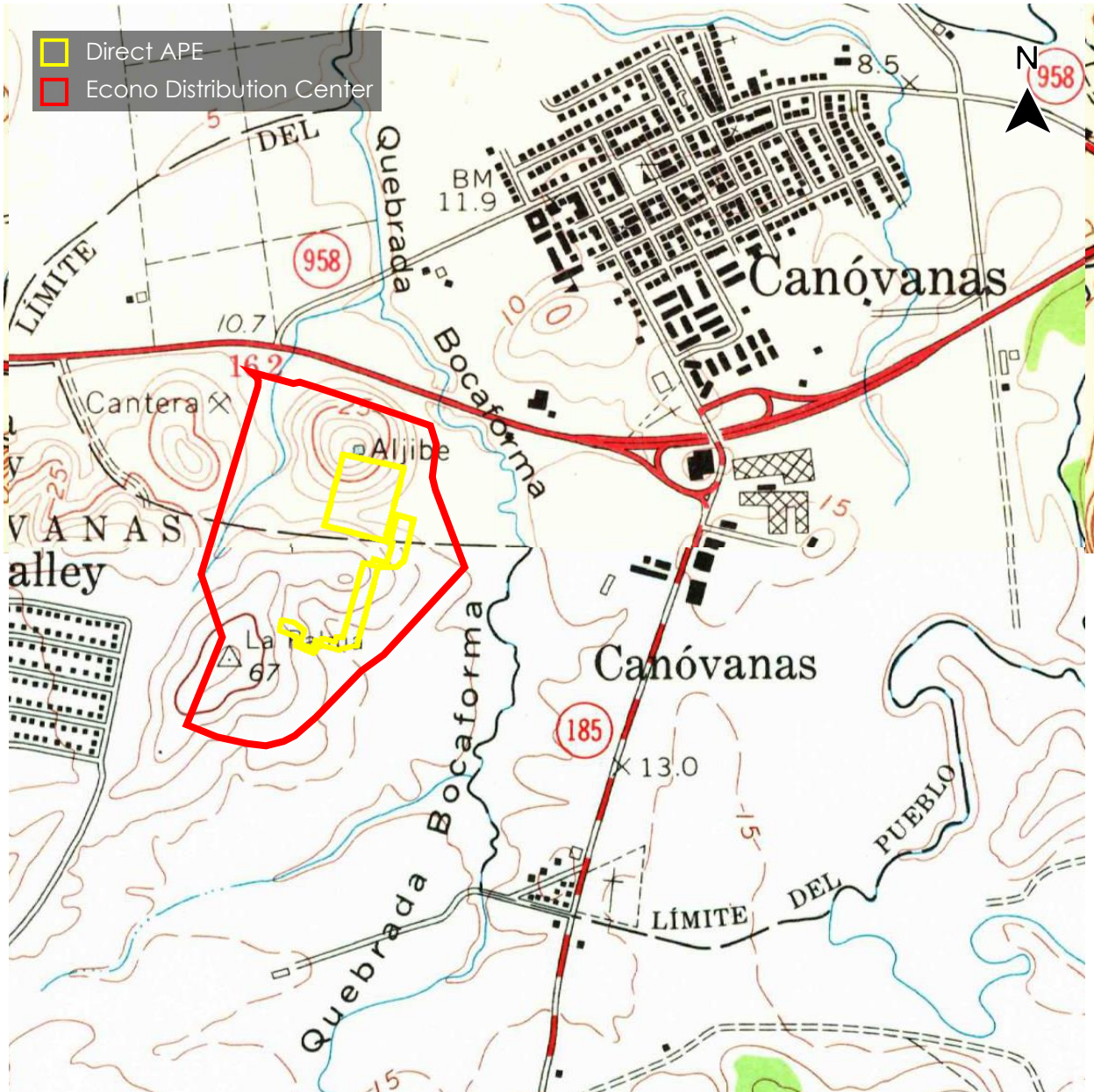

Figure 7. Composite image of 1972 USGS topographic maps (1:20,000 scale) of the Carolina Quadrangle (above) and the Gurabo Quadrangle (below) (Source: USGS topoView, <https://ngmdb.usgs.gov/topoview/>).

Subrecipient: Supermercados Econo, Inc.

Program ID: PR-IPGM-00375

Project Name: Econo Energy Project



Figure 8. 2006 panoramic photograph of the quarry prior to construction of the Econo Distribution Center, looking northeast (Source: *Evaluación Arqueológica Fase 1A-1B, Proyecto Residencial y Comercial El Nuevo Comandante, Carr. PR-3, Barrio Pueblo, Martínez Garayalde 2006*).

Subrecipient: Supermercados Econo, Inc.

Program ID: PR-IPGM-00375

Project Name: Econo Energy Project

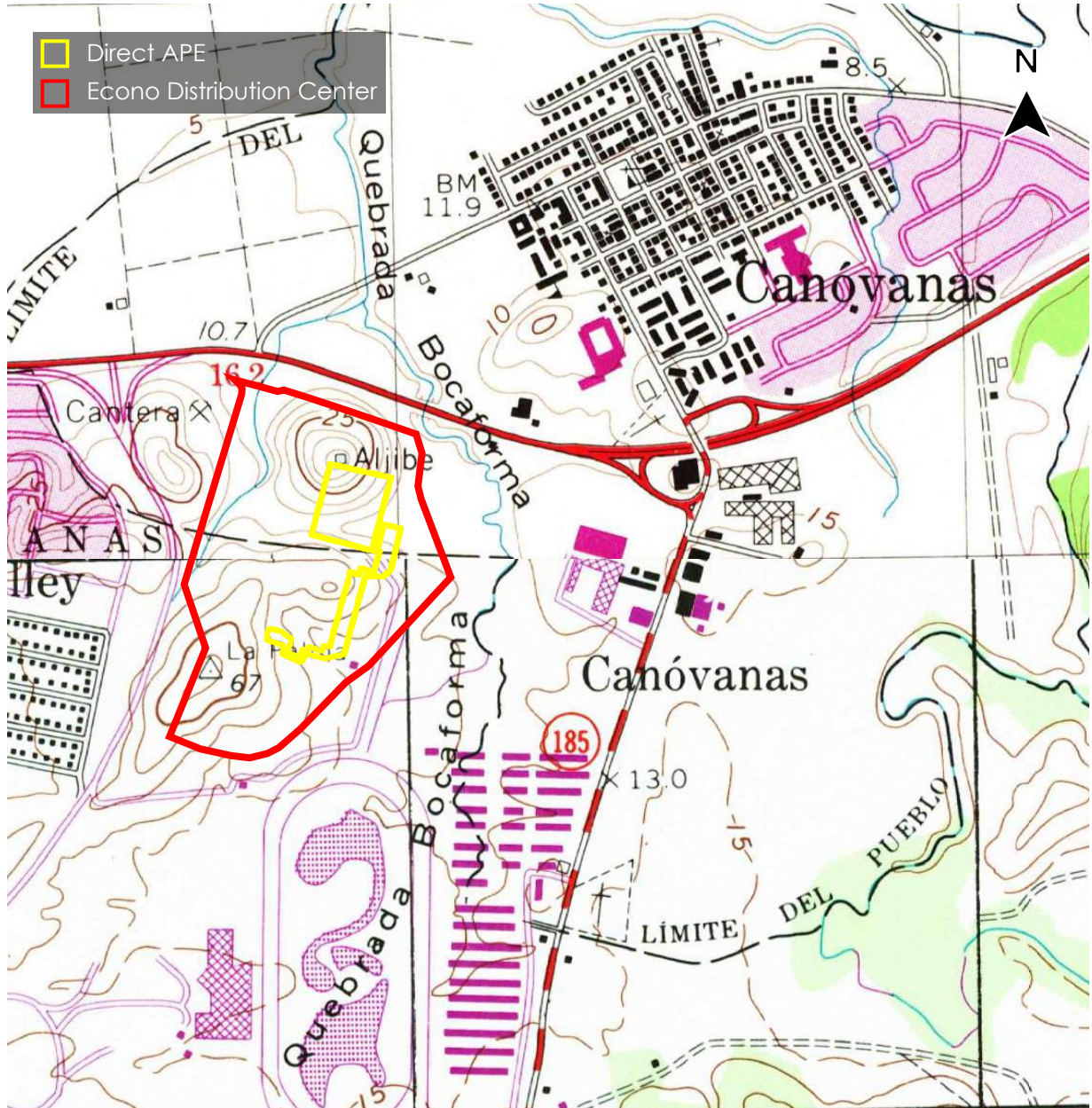

Figure 9. Composite image of 1982 USGS topographic maps (1:20,000 scale) of the Carolina Quadrangle (above) and the Gurabo Quadrangle (below) (Source: USGS topoView, <https://ngmdb.usgs.gov/topoview/>).

Subrecipient: Supermercados Econo, Inc.

Program ID: PR-IPGM-00375

Project Name: Econo Energy Project



Figure 10. 1937 USGS aerial photograph of the town of Canóvanas, a ward pertaining to the Municipality of Loíza at the time (Source: Office of Photogrammetry, Department of Transportation and Public Works https://fotosaereas.dtop.pr.gov/apps/Shop_ACTGIS/).

Subrecipient: Supermercados Econo, Inc.

Program ID: PR-IPGM-00375

Project Name: Econo Energy Project

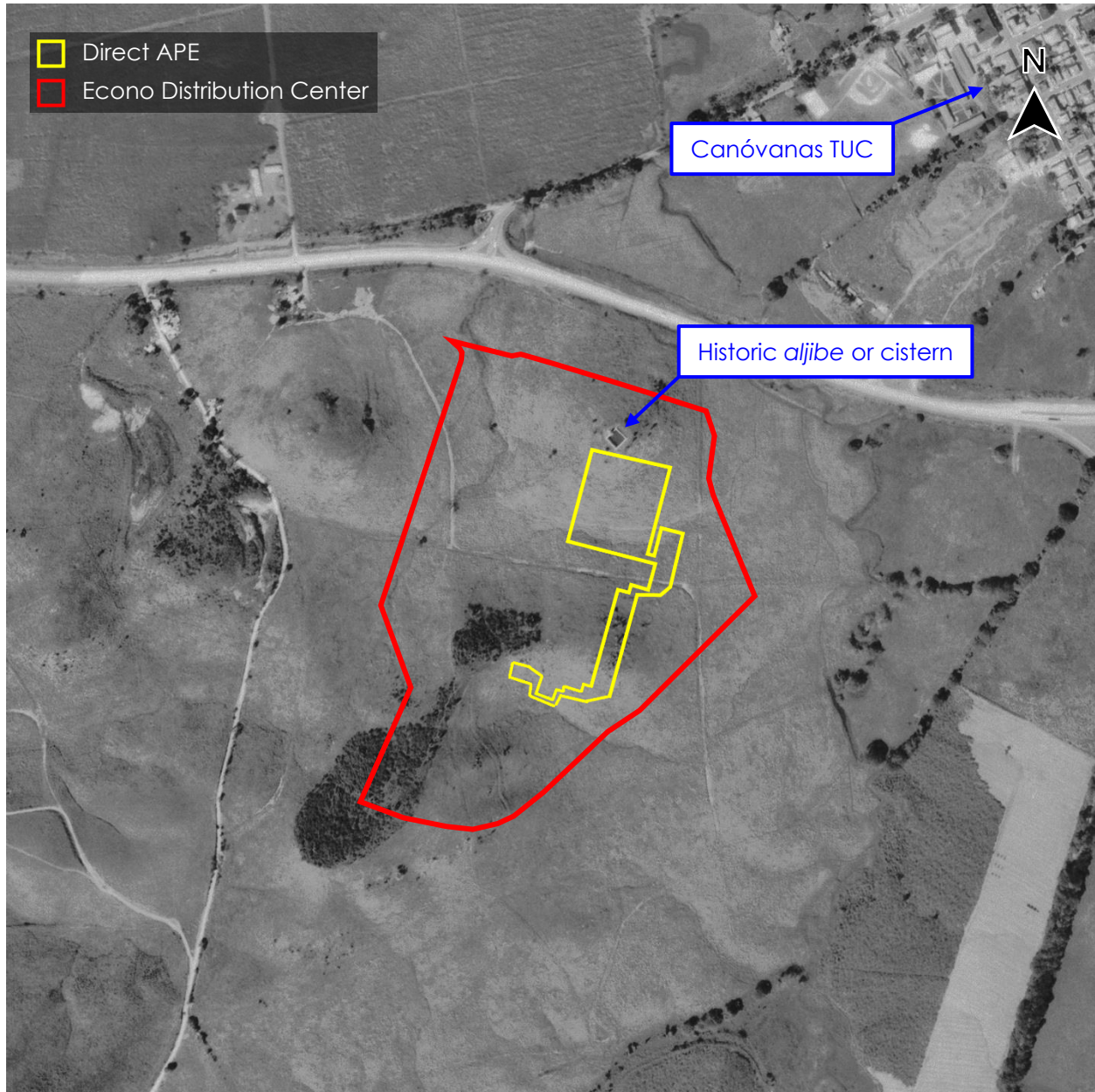

Figure 11. 1962 USGS aerial photograph of State Road PR-3, depicting the Canóvanas TUC. At this time Canóvanas was a barrio or ward of the Municipality of Loíza. This is the closest TUC to the direct APE, beyond a quarter mile radius (Source: Historic Aerials, <https://www.historicaerials.com/>).

Subrecipient: Supermercados Econo, Inc.

Program ID: PR-IPGM-00375

Project Name: Econo Energy Project



Figure 12. 2002 satellite image of the quarry, operating from the 1960s to 2006, south of State Road PR-3, in the Municipality of Canóvanas (Source: Google Earth Pro, <https://www.google.com/intl/es/earth/about>).

PUERTO RICO 2017 DISASTER RECOVERY, CDBG-DR PROGRAM Investment Portfolio for Growth Program (IPG-DR and IPG-MIT) Section 106 NHPA Effect Determination	 GOVERNMENT OF PUERTO RICO DEPARTMENT OF HOUSING
Subrecipient: Supermercados Econo, Inc.	
Program ID: PR-IPGM-00375	
Project Name: Econo Energy Project	

Determination

The following historic properties have been identified within the APE and the Program has determined the project will have the following effects on them:

- Direct Effect: There are no NRHP-listed/eligible historic properties within the direct APE of the proposed High-Efficiency Hybrid Power Plant for the Supermercados Econo Distribution Center in Canóvanas, Puerto Rico. The area was originally a modern quarry, operating with drastic impact to the terrain from the 1960s 2006. The proposed undertaking has an estimated depth of impact of one foot. The original hill terrain was reduced by over 42 meters, as revealed by the destruction of a 1930s *aljibe* or cistern, documented in historic aerial photographs and topographic maps. The potential for unearthing intact material deposits is considered zero.
- Indirect Effect: There are no listed NRHP-listed/eligible historic properties within the viewshed or visual APE at ground level, nor within a quarter-mile radius. The Casa Jesús T. Piñero; TCN-EH5 (CW0200010), is located 0.31 miles northwest, and the Canóvanas Traditional Urban Center is located 0.35 miles northeast. Given the distance to both historic properties, and the minimal scale of the proposed High-Efficiency Hybrid Power Plant for the Supermercados Econo Distribution Center, no indirect effects are anticipated.

PUERTO RICO 2017 DISASTER RECOVERY, CDBG-DR PROGRAM Investment Portfolio for Growth Program (IPG-DR and IPG-MIT) Section 106 NHPA Effect Determination	 GOVERNMENT OF PUERTO RICO DEPARTMENT OF HOUSING
Subrecipient: Supermercados Econo, Inc.	
Program ID: PR-IPGM-00375	
Project Name: Econo Energy Project	

Recommendation

The Puerto Rico Department of Housing requests that the Puerto Rico SHPO concur that the following determination is appropriate for the undertaking (Choose One):

- No Historic Properties Affected
- No Adverse Effect
Condition:
- Adverse Effect
Proposed Resolution:

This Section is to be Completed by SHPO Staff Only

The Puerto Rico State Historic Preservation Office has reviewed the above information and: <ul style="list-style-type: none"> <input type="checkbox"/> Concurs with the information provided. <input type="checkbox"/> Does not concur with the information provided. 	
Comments:	
Carlos Rubio-Cancela State Historic Preservation Officer	Date:

Subrecipient: Supermercados Econo, Inc.

Program ID: PR-IPGM-00375

Project Name: Econo Energy Project



Project (Parcel) Location - Area of Potential Effect Map (Aerial) (Source: 2023 Satellite Image, Google Earth Pro, <https://www.google.com/intl/es/earth/about/versions>).

Subrecipient: Supermercados Econo, Inc.

Program ID: PR-IPGM-00375

Project Name: Econo Energy Project

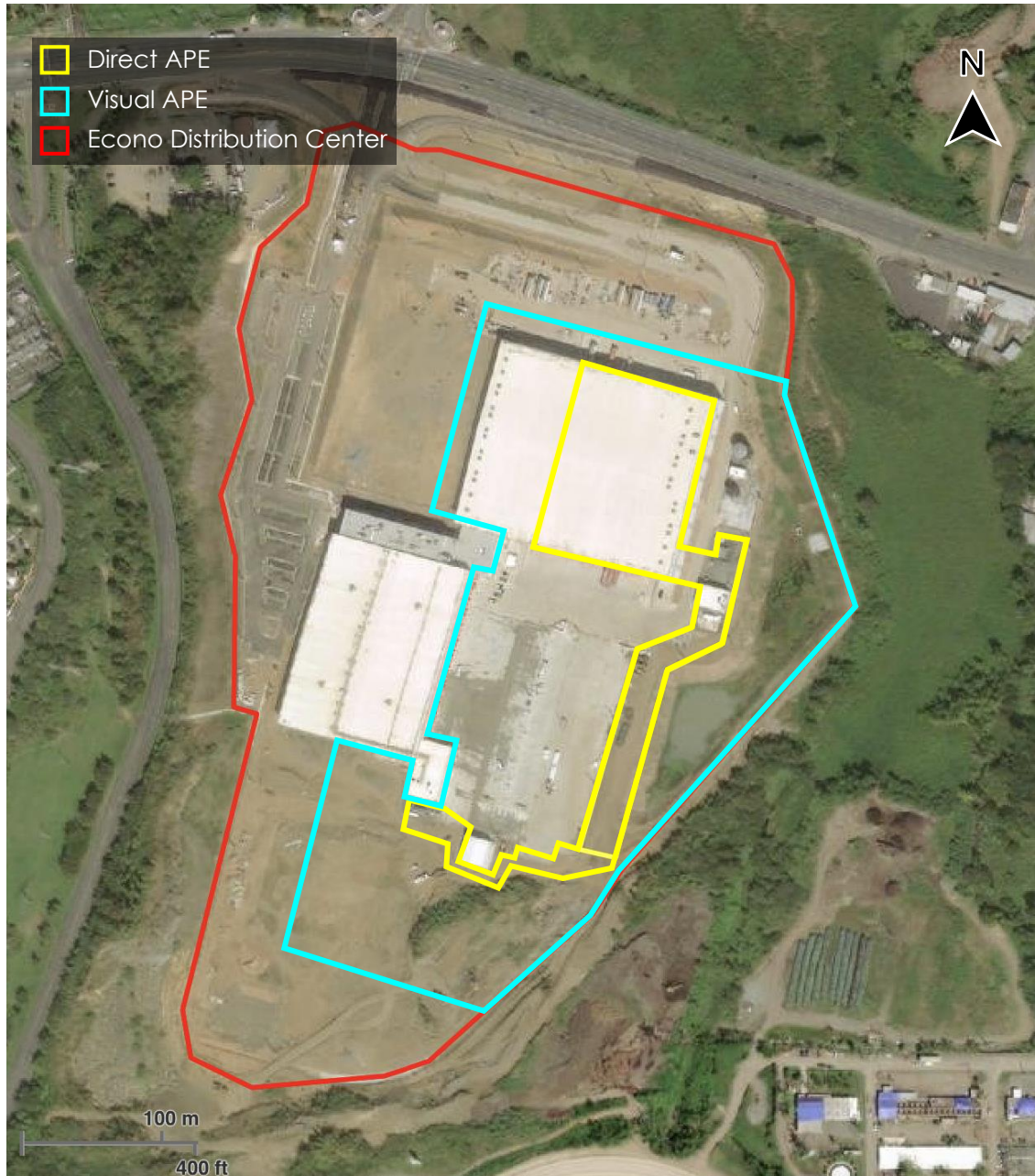

Project (Parcel) Location - Aerial Map (Source: Interactive Map of United States Environmental Protection Agency, NEPAassist, <https://nepassisttool.epa.gov/nepassist/nepamap.aspx>).

Subrecipient: Supermercados Econo, Inc.

Program ID: PR-IPGM-00375

Project Name: Econo Energy Project

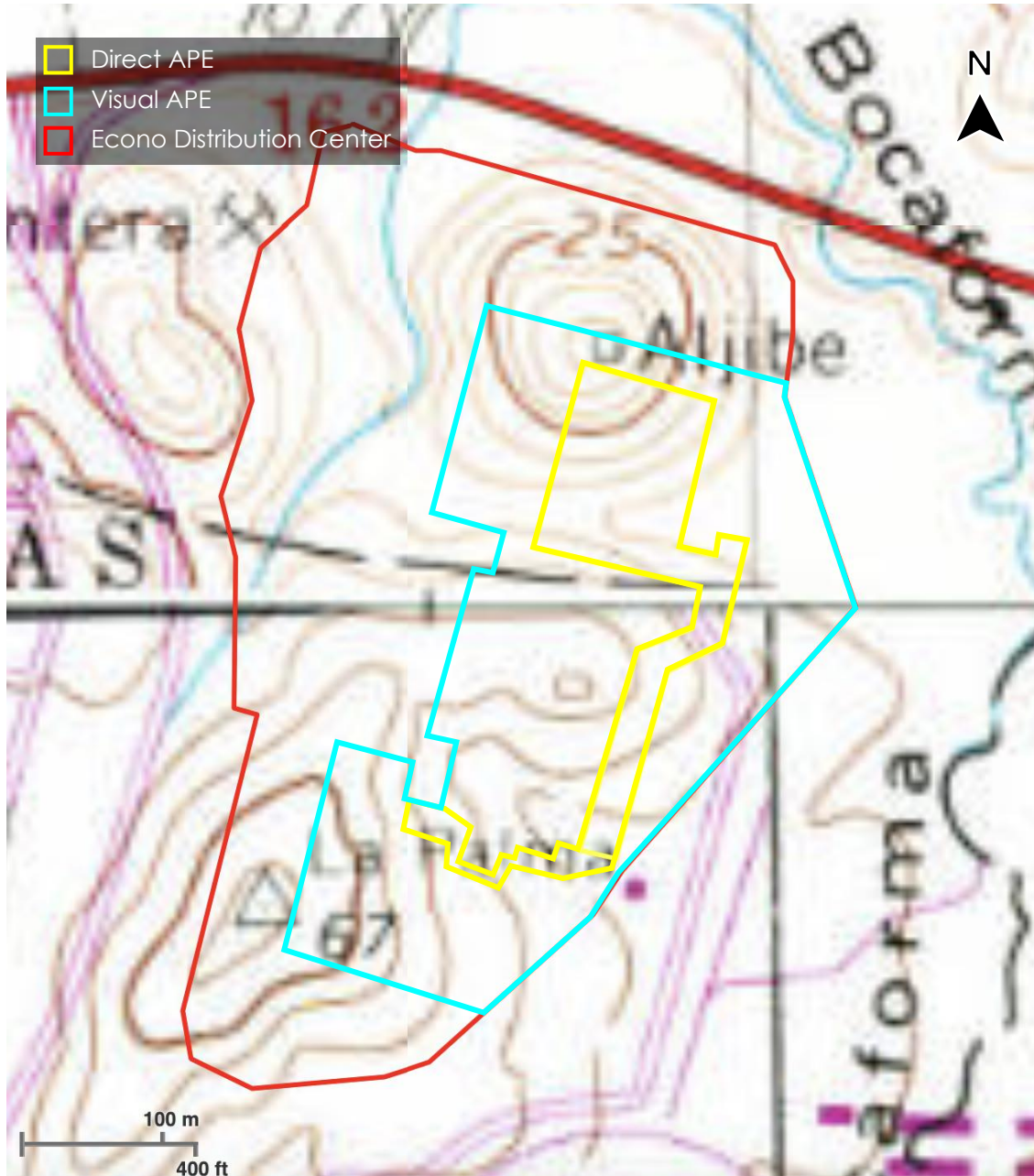

Project (Parcel) Location - Topographic Map (Source: Interactive Map of United States Environmental Protection Agency, NEPAassist, <https://nepassisttool.epa.gov/nepassist/nepamap.aspx>).

Subrecipient: Supermercados Econo, Inc.

Program ID: PR-IPGM-00375

Project Name: Econo Energy Project

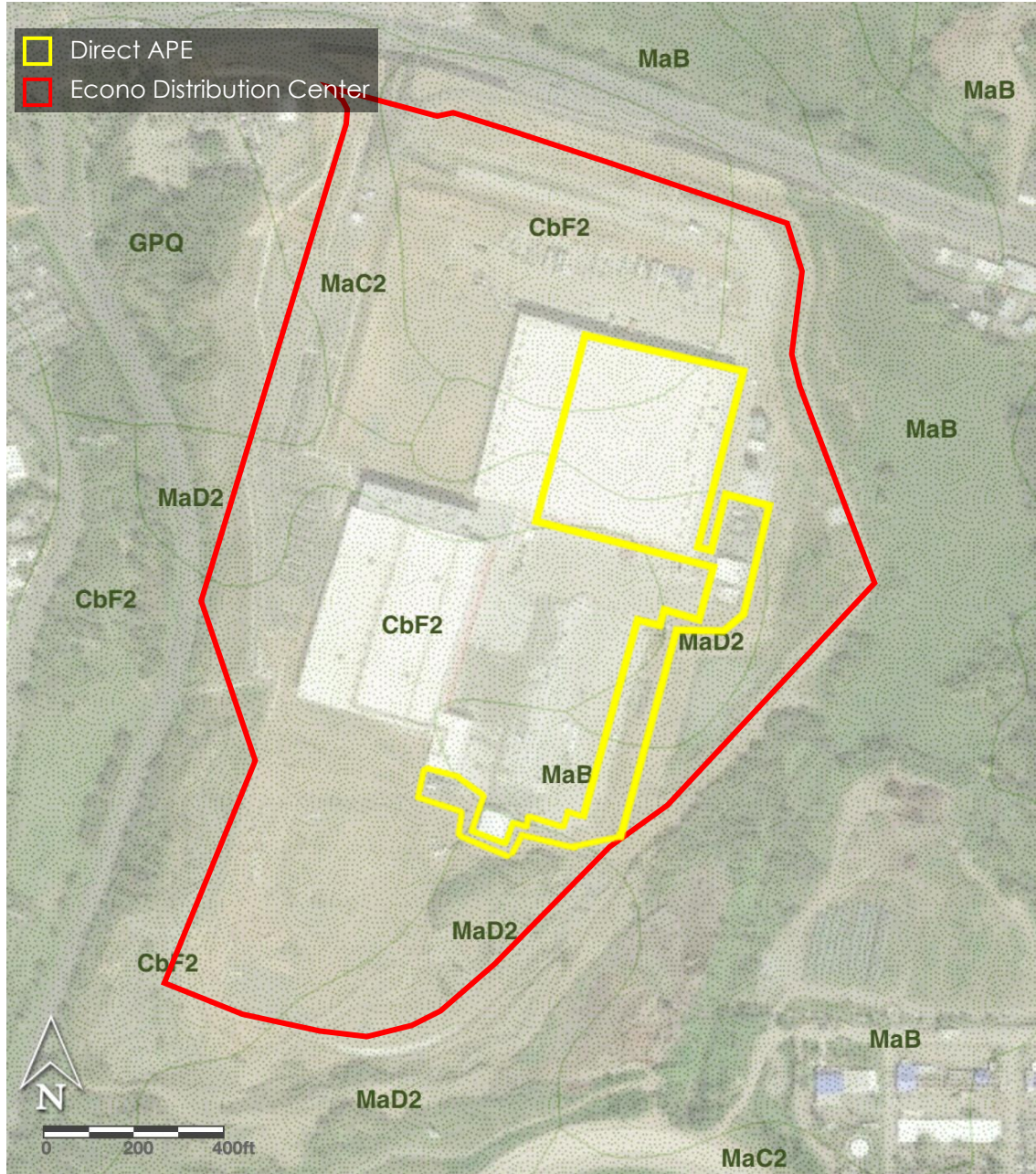

Project (Parcel) Location - Soils Map (Source: Interactive Map of Puerto Rico Planning Board, MIPR, <http://gis.jp.pr.gov/mipr/>).

Subrecipient: Supermercados Econo, Inc.

Program ID: PR-IPGM-00375

Project Name: Econo Energy Project

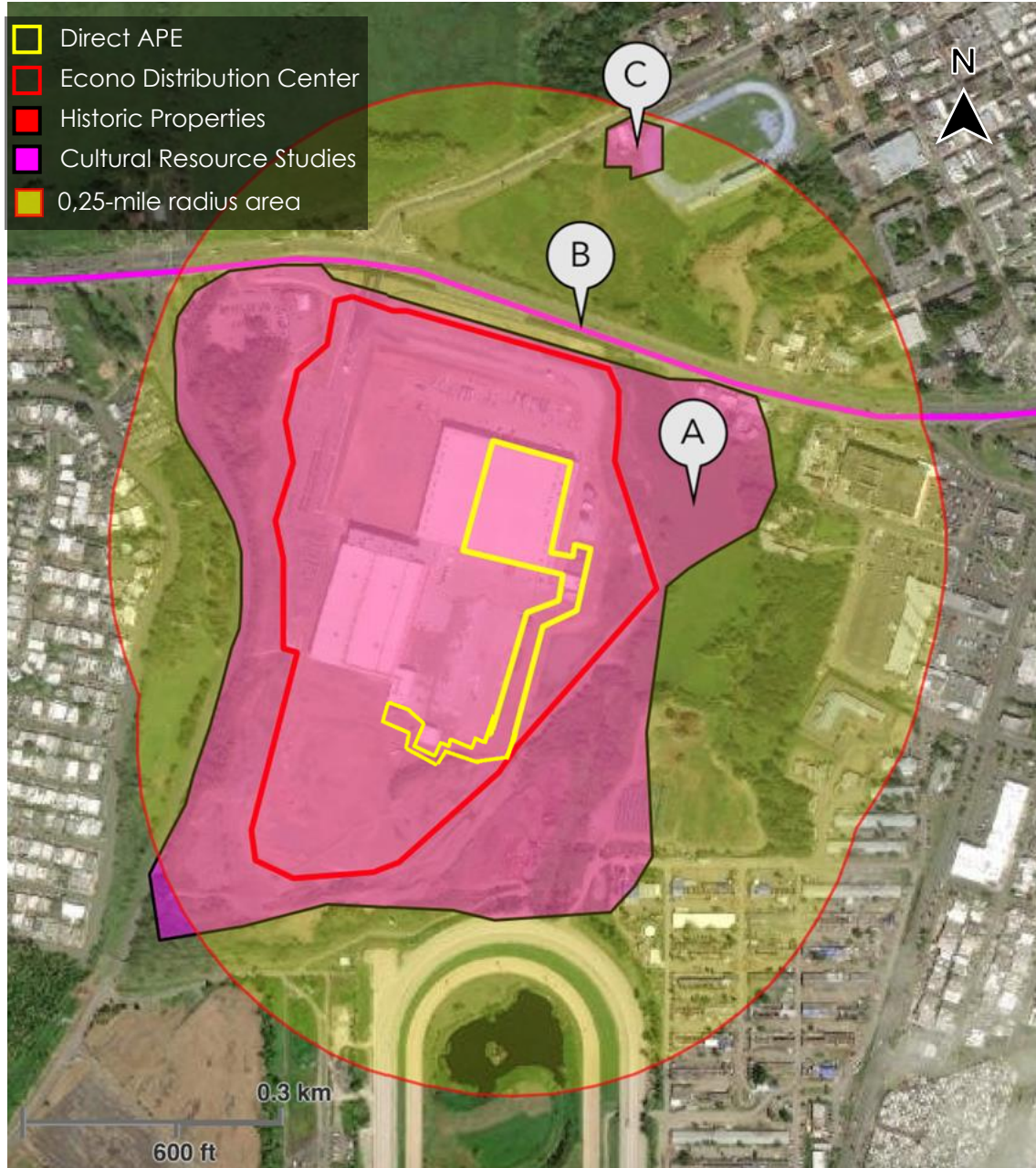

Project (Parcel) Location w/ Previous Cultural Resource Studies - Aerial Map (Source: Interactive Map of United States Environmental Protection Agency, NEPAassist, <https://nepassisttool.epa.gov/nepassist/nepamap.aspx>). The yellow-filled polygon is the 0.25-mile radius.

Subrecipient: Supermercados Econo, Inc.

Program ID: PR-IPGM-00375

Project Name: Econo Energy Project

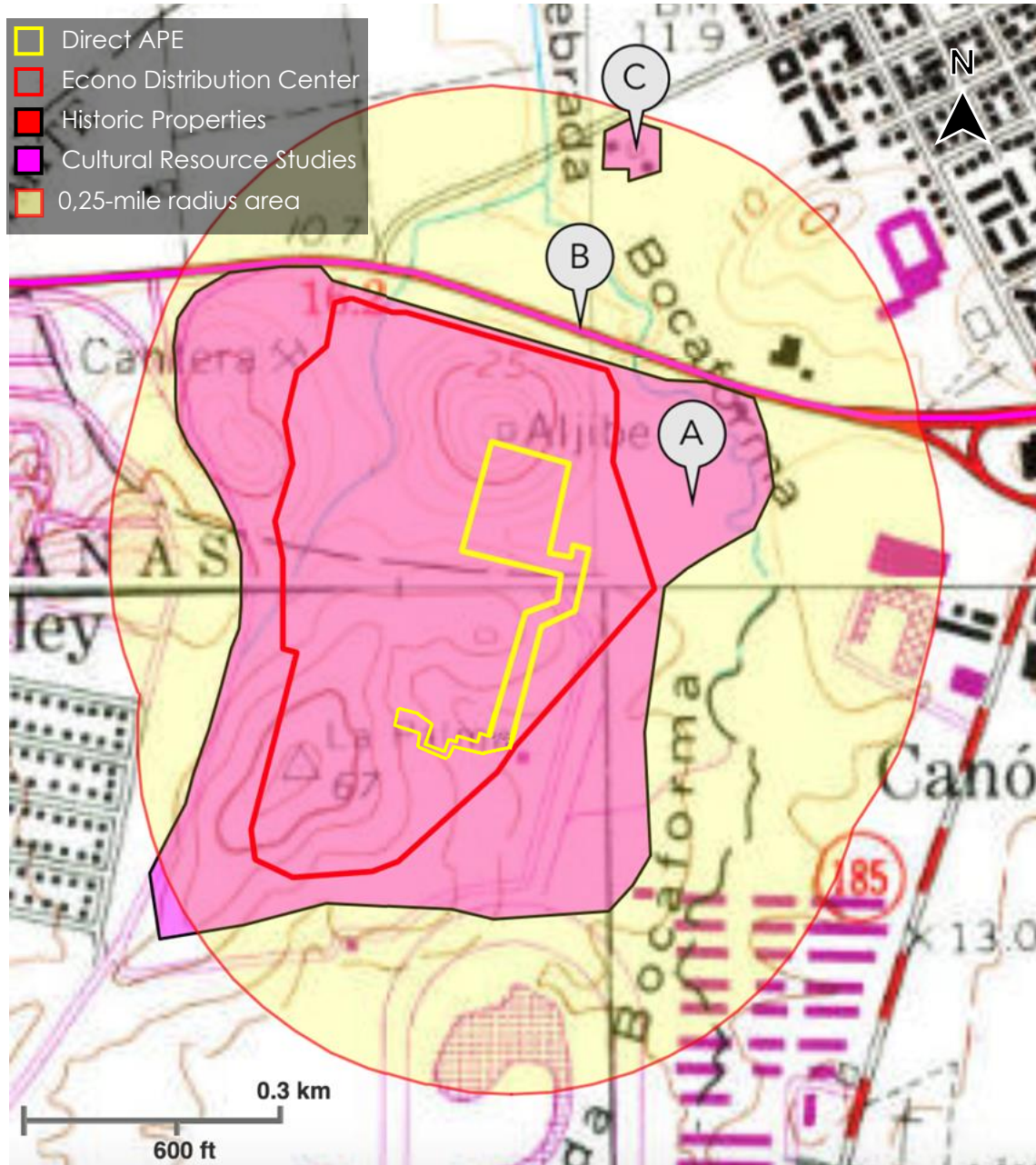

Project (Parcel) Location w/ Previous Cultural Resource Studies - Topo Map (Source: Interactive Map of United States Environmental Protection Agency, NEPAassist, <https://nepassisttool.epa.gov/nepassist/nepamap.aspx>). The yellow-filled polygon is the 0.25-mile radius.

Subrecipient: Supermercados Econo, Inc.

Program ID: PR-IPGM-00375

Project Name: Econo Energy Project



Photograph Key - Direct APE (Source: 2023 Satellite Image, Google Earth Pro, <https://www.google.com/intl/es/earth/about/versions>).

Subrecipient: Supermercados Econo, Inc.

Program ID: PR-IPGM-00375

Project Name: Econo Energy Project



Photo: 1

Description: Rooftop of non-refrigerated warehouse in Econo Distribution Center, for placing BESS solar panels, looking southeast.

Date: 6/17/2024



Photo: 2

Description: Area for control room, gas-powered generator, Battery Energy Storage System, evaporator, buffer tank, and cooling tower, looking northeast from the non-refrigerated warehouse rooftop.

Date: 6/17/2024

Subrecipient: Supermercados Econo, Inc.

Program ID: PR-IPGM-00375

Project Name: Econo Energy Project



Photo: 3

Description: Area for liquefied natural gas tank, auxiliary equipment, and drying beds, looking southeast from the non-refrigerated warehouse rooftop.

Date: 6/17/2024



Photo: 4

Description: Fuel tank and pump room, looking east.

Date: 6/17/2024

PUERTO RICO 2017 DISASTER RECOVERY, CDBG-DR PROGRAM
Investment Portfolio for Growth Program (IPG-DR and IPG-MIT)
Section 106 NHPA Effect Determination



Subrecipient: Supermercados Econo, Inc.

Program ID: PR-IPGM-00375

Project Name: Econo Energy Project



Photo: 5

Description: Fuel tank and emergency genertor, looking southeast.

Date: 6/17/2024

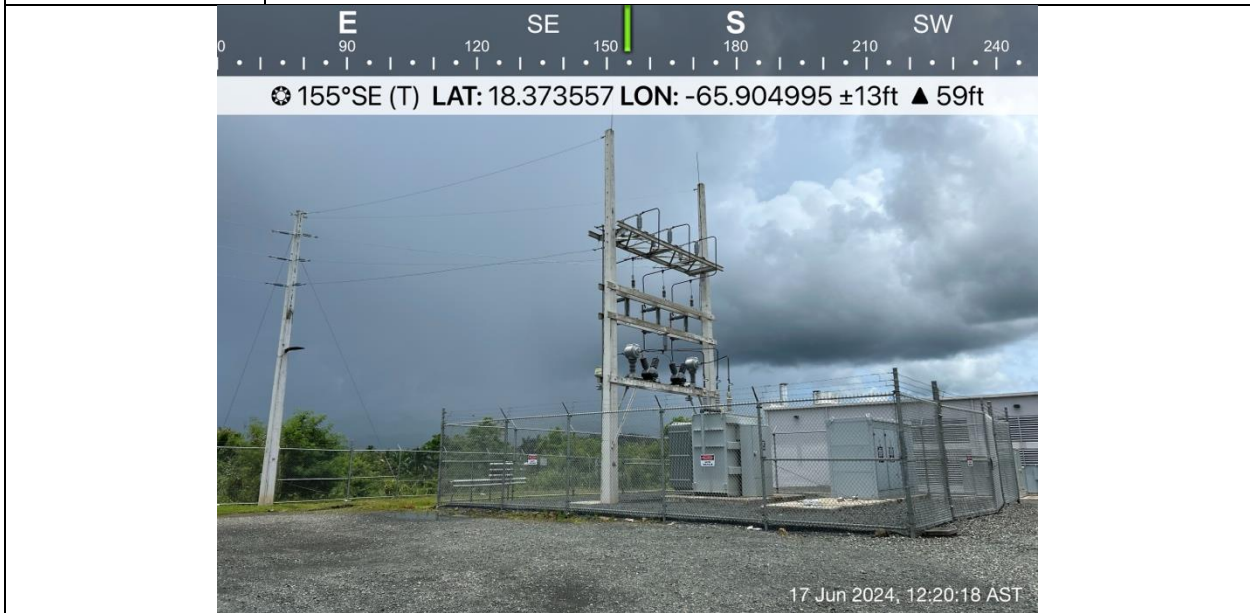

Photo: 6

Description: Switchboard and transformers, looking southeast.

Date: 6/17/2024

Subrecipient: Supermercados Econo, Inc.

Program ID: PR-IPGM-00375

Project Name: Econo Energy Project



Photo: 7

Description: Secondary transformer with electric substation to the right, looking northwest.

Date: 6/17/2024



Photo: 8

Description: Generator room with secondary transformer, looking southeast.

Date: 6/17/2024

PUERTO RICO 2017 DISASTER RECOVERY, CDBG-DR PROGRAM
Investment Portfolio for Growth Program (IPG-DR and IPG-MIT)
Section 106 NHPA Effect Determination



Subrecipient: Supermercados Econo, Inc.

Program ID: PR-IPGM-00375

Project Name: Econo Energy Project



Photo: 9

Description: Area for liquefied natural gas tank, auxiliary equipment, and drying beds at the end, looking southwest.

Date: 6/17/2024



Photo: 10

Description: Non-refrigerated warehouse and shipping containers, looking southwest.

Date: 6/17/2024

Subrecipient: Supermercados Econo, Inc.

Program ID: PR-IPGM-00375

Project Name: Econo Energy Project

LAT: 18.371783 LON: -65.906858



Photo: 11

Description: Cooling towers, looking west.

Date: 9/16/2024

LAT: 18.371528 LON: -65.906908



Photo: 12

Description: Cooling towers and cold storage, looking northwest.

Date: 9/16/2024

PUERTO RICO 2017 DISASTER RECOVERY, CDBG-DR PROGRAM
Investment Portfolio for Growth Program (IPG-DR and IPG-MIT)
Section 106 NHPA Effect Determination



Subrecipient: Supermercados Econo, Inc.

Program ID: PR-IPGM-00375

Project Name: Econo Energy Project

LAT: 18.372908 **LON:** -65.906792



Photo: 13

Description: Area for liquefied natural gas tank, auxiliary equipment, and drying beds, looking northeast.

Date: 9/16/2024

PR-IPGM-00375

**Supermercados Econo - Energy Project
Project**



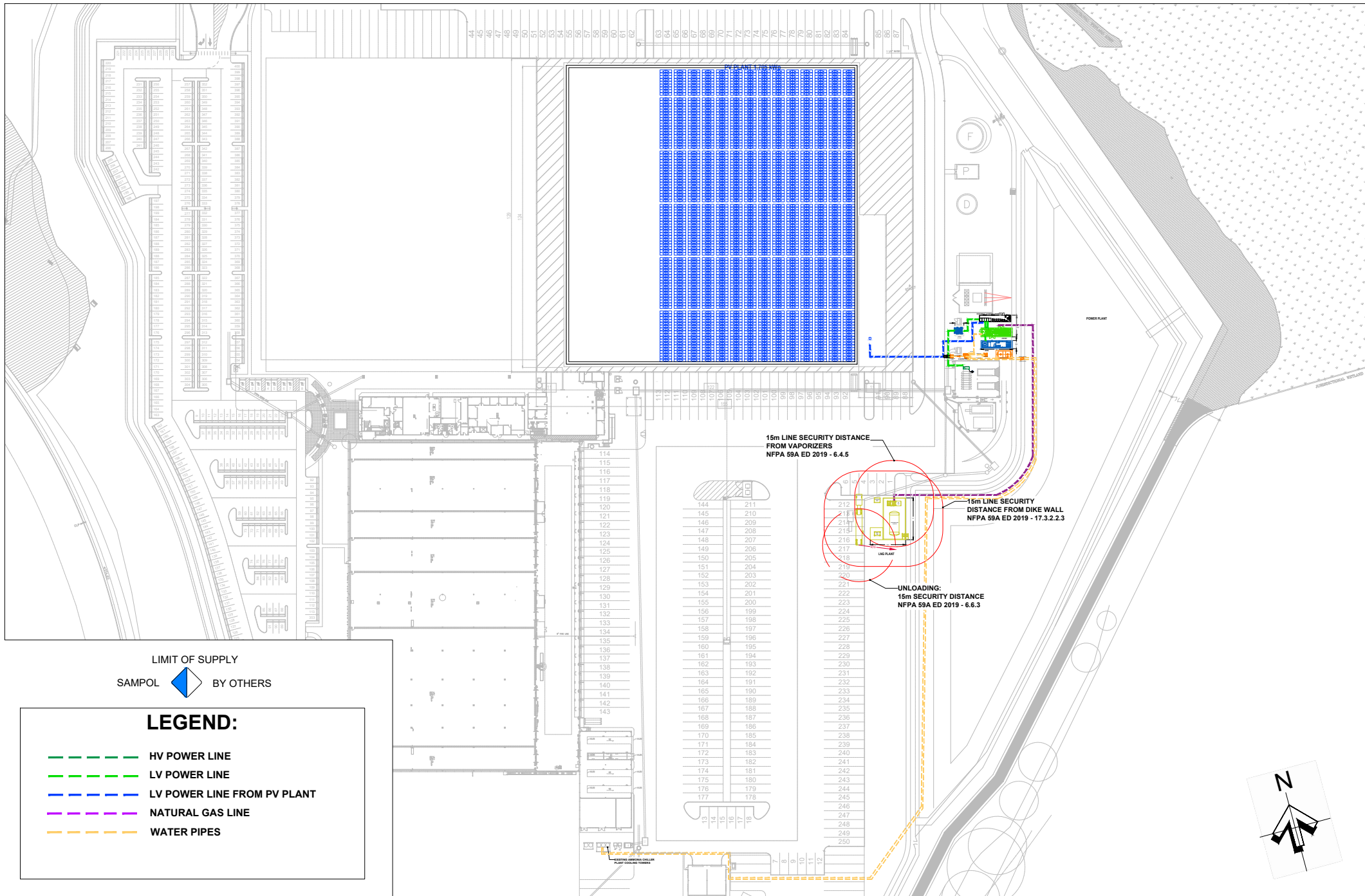

Canóvanas, Puerto Rico

Design Drawings



LIMIT OF SUPPLY
 SAMPOL  BY OTHERS

LEGEND:

-  HV POWER LINE
-  LV POWER LINE
-  LV POWER LINE FROM PV PLANT
-  NATURAL GAS LINE
-  WATER PIPES

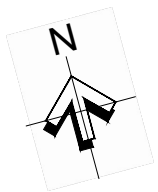

STA. 67



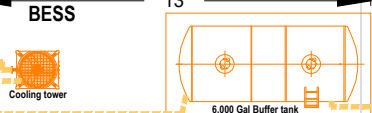
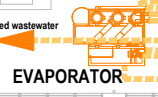
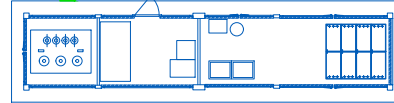
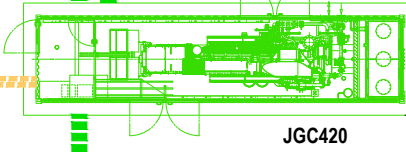
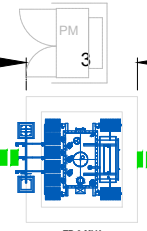
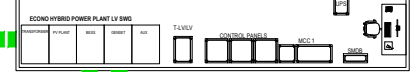

ECONO PV PLANT
LV SWG

ELECTRICAL & CONTROL ROOM



LIMIT OF SUPPLY
SAMPOL  BY OTHERS

LEGEND:

-  HV POWER LINE
-  LV POWER LINE
-  LV POWER LINE FROM PV PLANT
-  NATURAL GAS LINE
-  WATER PIPES

ELEC
MH1

8.9

3.4

13

Blowdown water inlet

Distilled water outlet



Client: HIGH EFFICIENCY HYBRID POWER PLANT
ECONO DISTRIBUTION CENTER
Canóvanas (Puerto Rico)

Title: LAYOUT POWER PLANT

Nº drawing: ECO-GEN-02-02-E14

Comments: PRELIMINAR DESIGN SUBJECTED TO MODIFICATIONS DURING THE PROJECT

Scale: 1:250
Date: July 2024



2,750 solar panels 620 Wp
PV PLANT 1,705 kWp

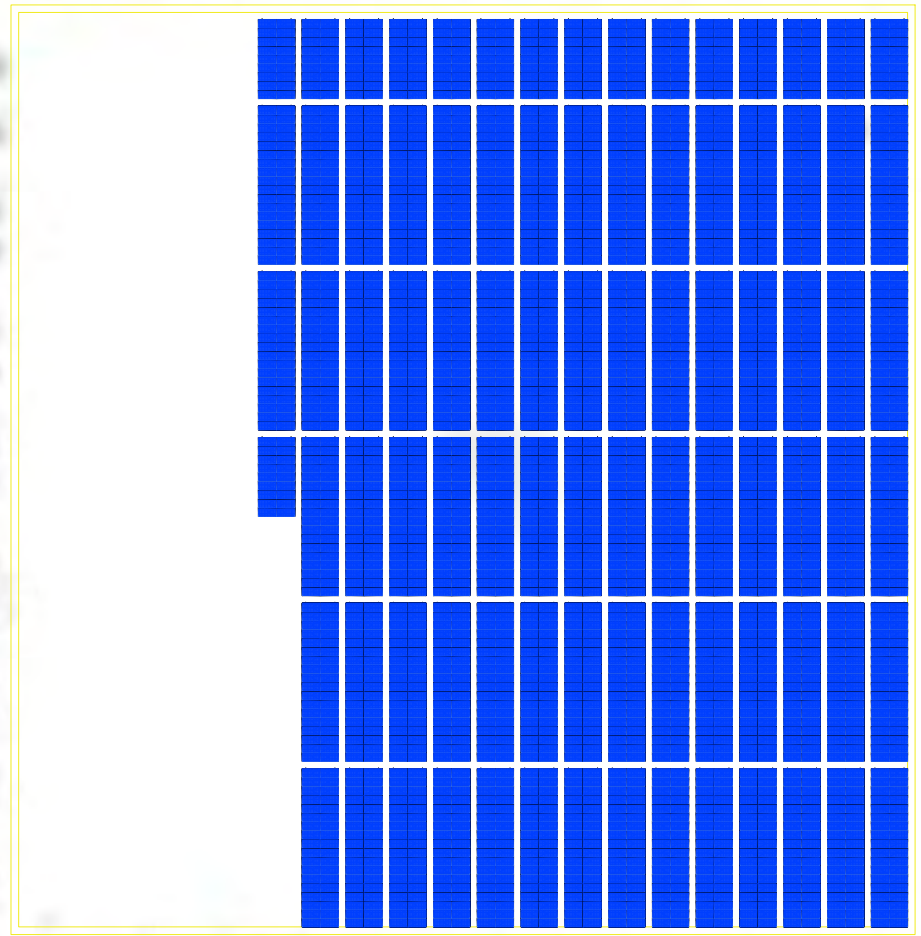

LAYOUT
E: 1:1000

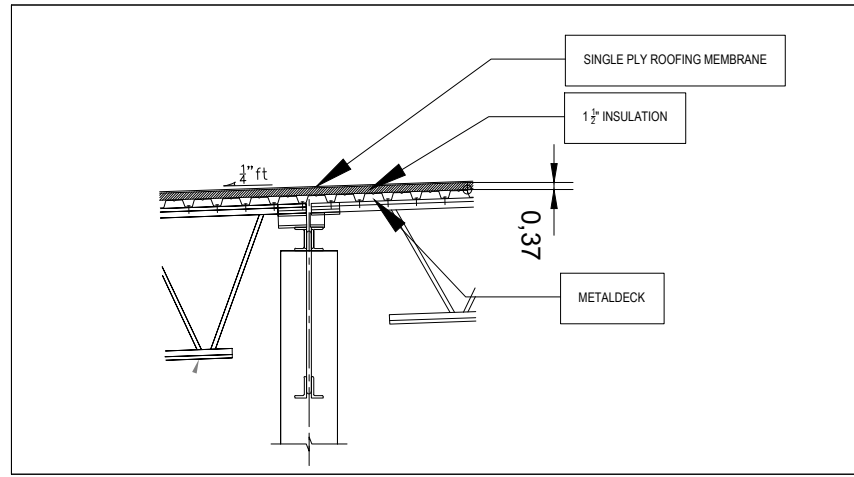

ROOF CONSTRUCTION DETAILS



Roof pictures

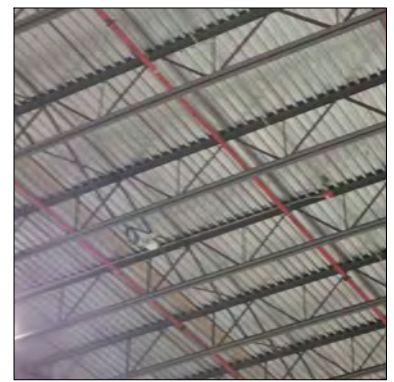

Construction roof support

2,750 solar panels 620 Wp

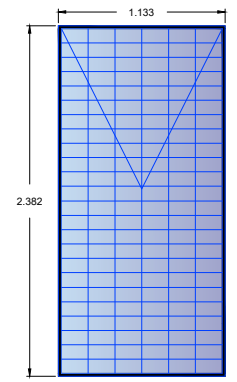

LONGI LR7-72HGD-620M



Client: SOLAR POWER PLANT
1.7 MWp
Canóvanas (Puerto Rico)

Title: PV LAYOUT

Nº drawing: ECO-GEN-02-03-E14

Comments: PRELIMINAR DESIGN SUBJECTED TO MODIFICATIONS
DURING THE PROJECT

Scale: 1:1000
Date: July 2024

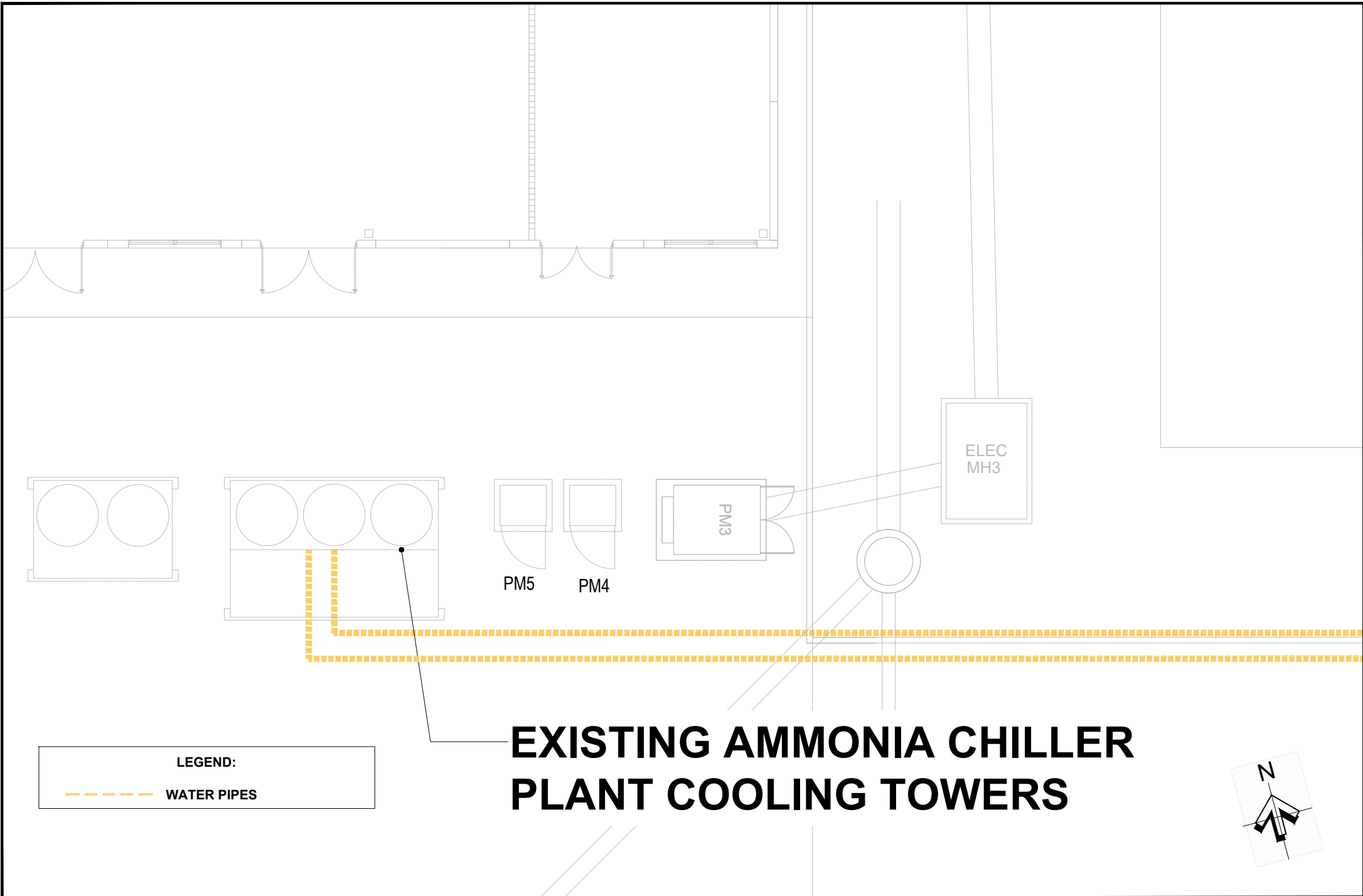

EXISTING AMMONIA CHILLER PLANT COOLING TOWERS

LEGEND:
 - - - - - WATER PIPES

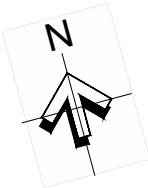

	<p>Client:</p>	<p>Project:</p> <p>HIGH EFFICIENCY HYBRID POWER PLANT ECONO DISTRIBUTION CENTER</p> <p><small>Canóvanas (Puerto Rico)</small></p>	<p>Title:</p> <p>LAYOUT AMMONIA CHILLER PLANT</p>	<p>Nº drawing:</p> <p>ECO-GEN-02-04-E14</p>	<p>Comments:</p> <p>PRELIMINAR DESIGN SUBJECTED TO MODIFICATIONS DURING THE PROJECT</p>	<p>Scale</p> <p>1:125</p> <p>Date:</p> <p>July 2024</p>
--	----------------	---	---	---	---	---

**15m LINE SECURITY DISTANCE
FROM VAPORIZERS
NFPA 59A ED 2019 - 6.4.5**

**15m LINE SECURITY
DISTANCE FROM DIKE WALL
NFPA 59A ED 2019 - 17.3.2.2.3**

**UNLOADING:
15m SECURITY DISTANCE
NFPA 59A ED 2019 - 6.6.3**

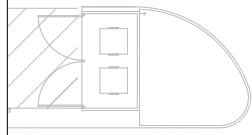

211
210
209
208
207
206
205
204
203
202
201
200

6
5
4
3
2
1

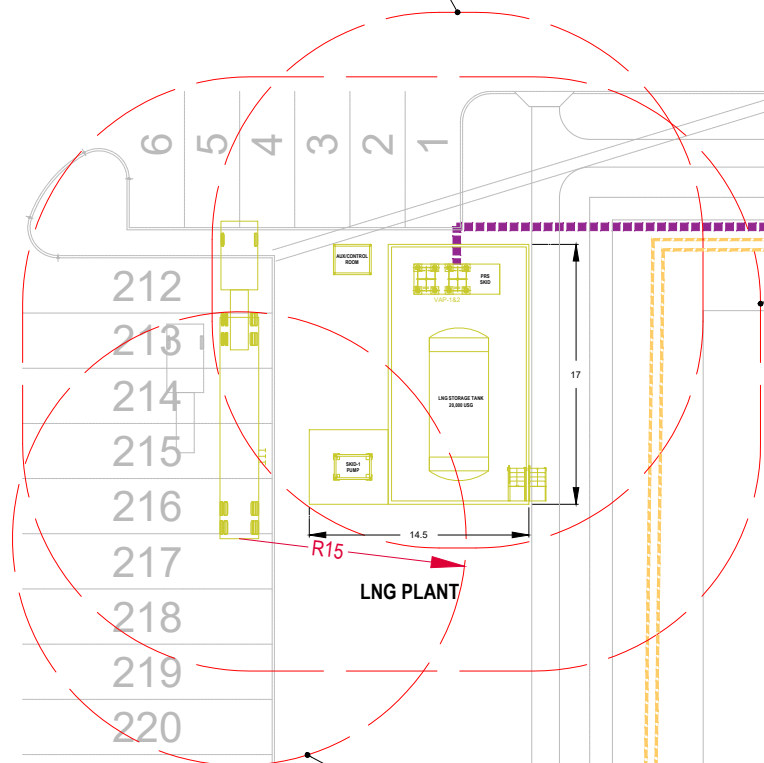

LEGEND:

--- NATURAL GAS LINE

--- WATER PIPES



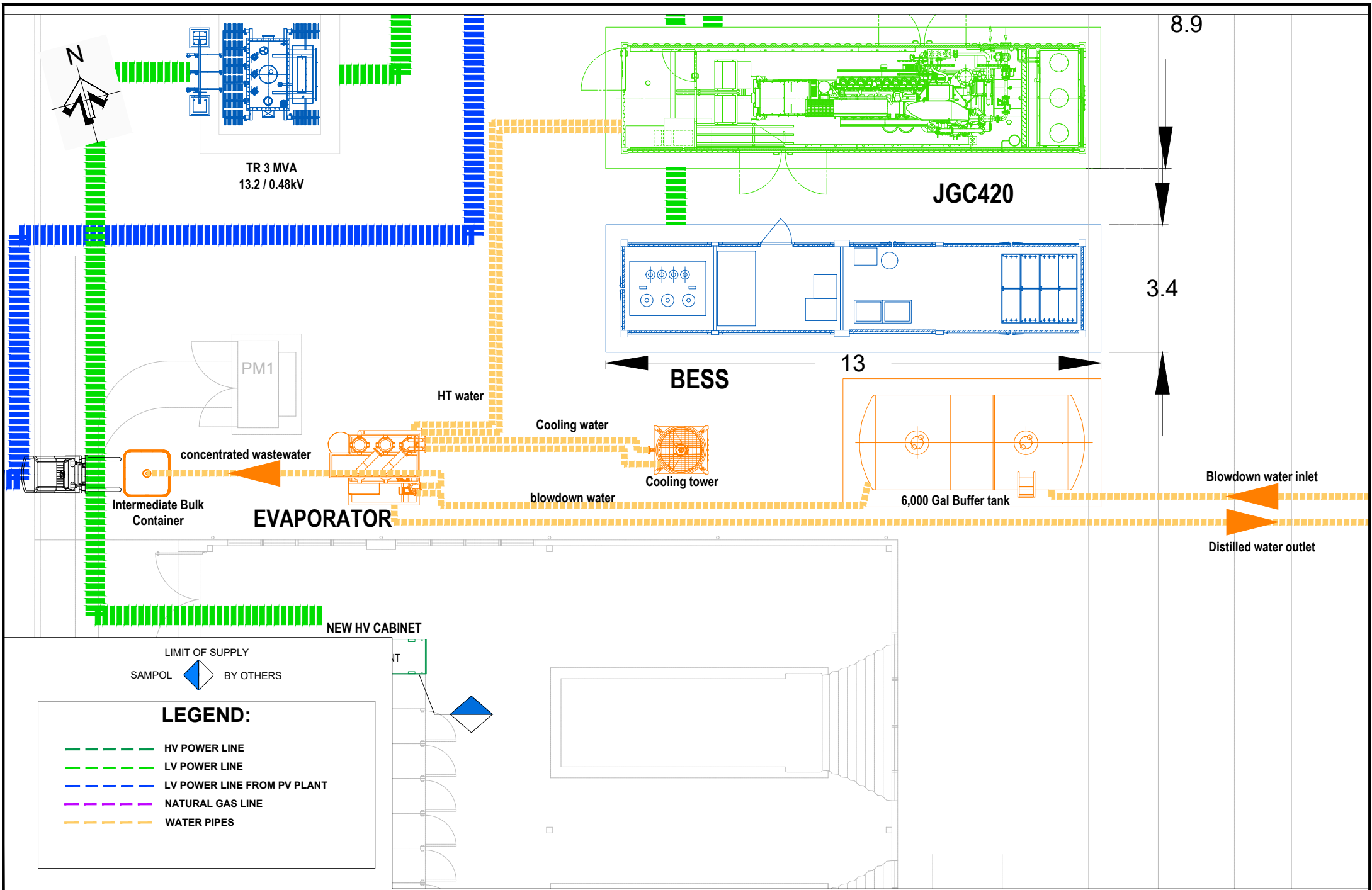

Appendix 14

Sole Source Aquifers

Econo Energy Project

Project ID: IPGM-00375

Address: State Road PR-3, Int. PR 9959, Km. 15.21 Bo. Canovanillas, Canóvanas, PR. 00729

Coordinates: 18.373613° -65.906549° 

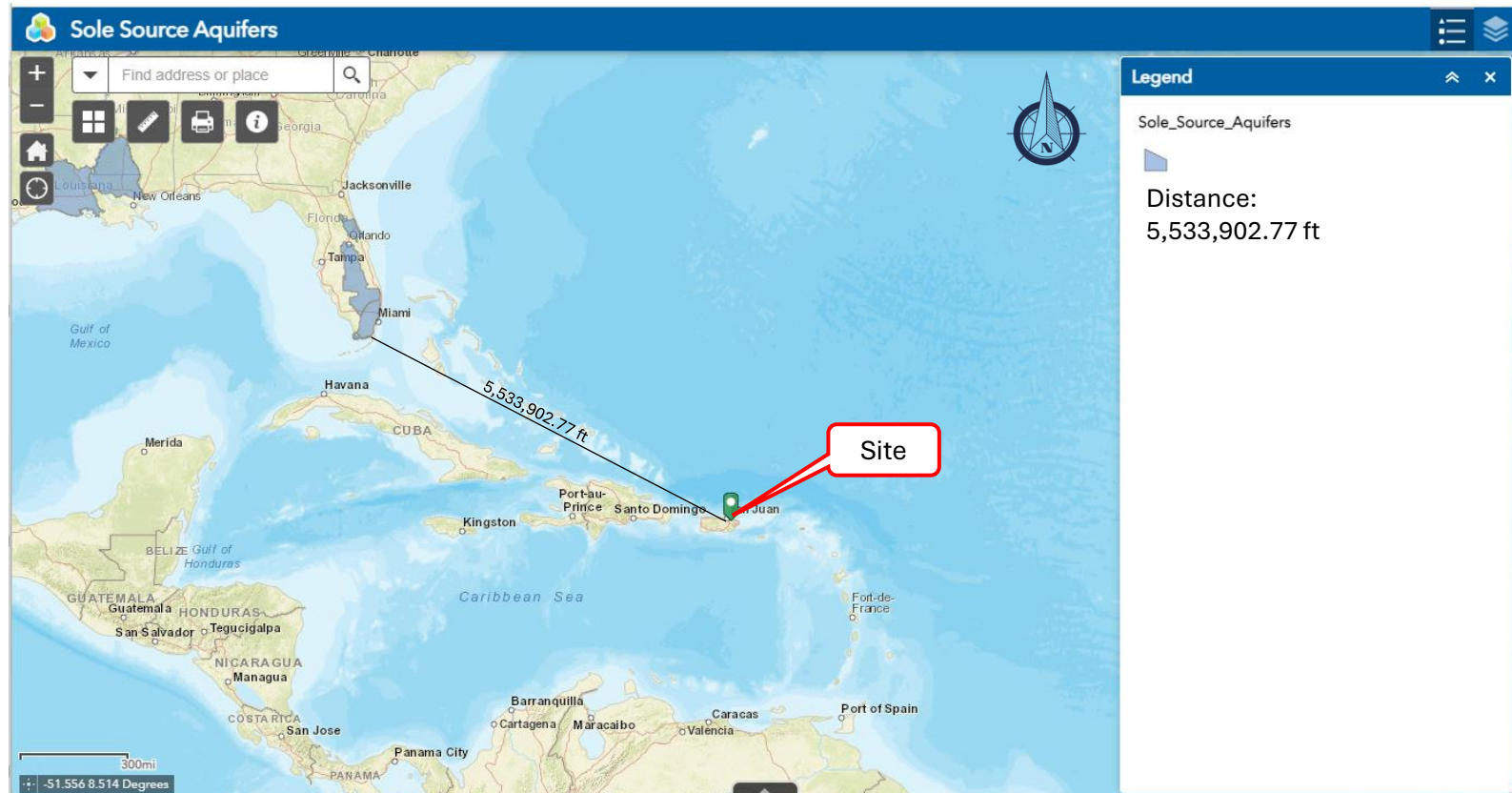
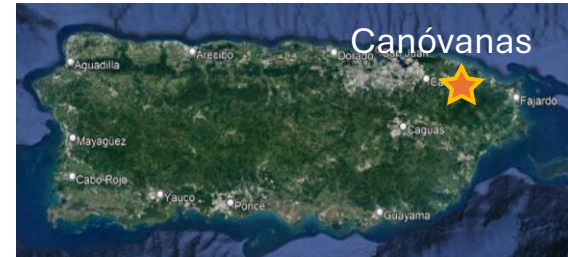

Map Source: Environmental Protection Agency, Sole Source Aquifers program, Map of Sole Source Aquifers Location, accessed 7/17/2024

<https://www.epa.gov/dwssa/map-sole-source-aquifer-locations>

Spatial reference: unknwn

Appendix 15

Wetland Map

Econo Energy Project

Project ID: IPGM-00375

Address: State Road PR-3, Int. PR 9959, Km. 15.21 Bo.

Canovanillas, Canóvanas, PR. 00729

Coordinates: 18.373613° -65.906549°



May 19, 2024

Wetlands

- | | | |
|--------------------------------|-----------------------------------|----------|
| Estuarine and Marine Deepwater | Freshwater Emergent Wetland | Lake |
| Estuarine and Marine Wetland | Freshwater Forested/Shrub Wetland | Other |
| | Freshwater Pond | Riverine |

This map is for general reference only. The US Fish and Wildlife Service is not responsible for the accuracy or currentness of the base data shown on this map. All wetlands related data should be used in accordance with the layer metadata found on the Wetlands Mapper web site.

National Wetlands Inventory (NWI)

This page was produced by the NWI mapper

Source: <https://www.fws.gov/program/national-wetlands-inventory/wetlands-mapper>

Spatial reference: unknown

[CDBG-MIT] PROGRAM

[Economic Development Investment Portfolio for Growth- Lifeline Mitigation Program]

PRIMARY SCREENING FOR WETLANDS AS PER HUD's REGULATIONS AT 24 CFR 55.9(b)

General Information:		
Project Name (Case ID):	IPGM-00375	
Coordinates:	18.373613°, -65.906549°	
Parcel ID:	117-000-003-01-000	
Municipio:	Canóvanas	
Report Date:	06/17/2024	
Preparer:	Hector L. Sanchez Cruz	
Project Scope:		
Does this project involve new construction as defined in Executive Order 11990? <small>(The term "new construction" shall include draining, dredging, channelizing, filling, diking, impounding, and related activities and any structures or facilities begun or authorized after the effective date of the Order.)</small>	<input checked="" type="checkbox"/> Yes	<input type="checkbox"/> No <small>(Based on the response, the review is in compliance)</small>
Project Site Conditions: <small>(Indicate whether the area is impacted or not. If impacted, specify what elements or factors are present.)</small>	The site consists of a developed industrial site that was previously filled, leveled and has two large warehouses and parking areas.	

A. Visual Assessment (Desktop Study)

National Wetlands Inventory (NWI) Reference		
Coordinates: Click or tap here to enter text.		
Is the project area located in proximity to wetlands identified on the National Wetlands Inventory (NWI)?	<input type="checkbox"/> Yes	The project site is in proximity of wetlands identified on NWI.
	<input checked="" type="checkbox"/> No	The project site is not in proximity of wetlands identified on NWI.

B. Visual Assessment (Field Study)

Visual Assessment performed on: 6/17/2024	
List Individual(s) conducting the assessment. List weather conditions the day the assessment was performed, description of Site Conditions and Transects performed at site.	
Individual(s) present:	Engr. Hector L Sanchez Cruz

Weather Conditions: (Prior and during the site visit)	Sunny, clear day	
Where transects performed?	<input type="checkbox"/> Yes	<input checked="" type="checkbox"/> No
If performed, how many transects were performed per transects?	Click or tap here to enter text.	

Wetland Vegetation:		
Was vegetation identified throughout the visit?	<input type="checkbox"/> Yes	Wetland vegetation was identified. (Provide supporting documentation)
	<input checked="" type="checkbox"/> No	No wetland vegetation was identified. (Provide supporting documentation).

Wetland Hydrology:		
Was visual inundation, ponding or saturation present at the site?	<input type="checkbox"/> Yes	<input checked="" type="checkbox"/> No
Were watermarks present within site (If applicable)?	<input type="checkbox"/> Yes	<input checked="" type="checkbox"/> No
If performed, how many borings were performed per transects?	Click or tap here to enter text.	
If performed, how many samples were taken?	Click or tap here to enter text.	
If performed, was underground water found throughout borings?	<input type="checkbox"/> Yes	<input type="checkbox"/> No
If boring were performed, summarize determination of borings:	Click or tap here to enter text.	
Reasoning as for why borings were not performed:	The project area is an impacted and developed industrial site.	
Provide supporting documentation (Photo Log) with brief descriptions and georeferenced document of all boring sample locations taken at end of form.		

Hydric Soils:	
What is the NRCS' soil classification for this site?	Caguabo clay; Mabi clay; Gravel; Pits; Quarry
If performed, how many borings were performed per transects?	Click or tap here to enter text.
If performed, when were the borings performed?	Click or tap here to enter text.
If performed, how many samples were taken?	Click or tap here to enter text.
If performed, what were the identified soils for each sample?	Click or tap here to enter text.
If performed, does the identified soil sample concur with NRCS Soil Study Identification?	<input type="checkbox"/> Yes <input type="checkbox"/> No
If performed, was underground water found throughout borings?	<input type="checkbox"/> Yes <input type="checkbox"/> No
If boring were performed, summarize determination of borings:	Click or tap here to enter text.
Reasoning as for why borings were not performed:	The project area is an impacted and developed industrial site.
Provide supporting documentation (Photo Log) with brief descriptions and georeferenced document of all boring sample locations taken at end of form.	

Summary of Finding for Wetland Indicators	
Is there a presence of mentioned indicators or characteristics of wetlands within the assessed area?	<input type="checkbox"/> Wetlands Vegetation
	<input type="checkbox"/> Hydric Soils
	<input type="checkbox"/> Hydrology
	<input checked="" type="checkbox"/> No Indicators were observed

C. Determination

Visual Assessment Field Study and Desktop Study	
Based on Visual Assessment Field Study and Desktop Study:	<input type="checkbox"/> The primary screening conclusively determined that the project site contains wetlands.

Visual Assessment Field Study and Desktop Study		
	<input checked="" type="checkbox"/>	The primary screening conclusively determined that the project site does not contain wetlands.
	<input type="checkbox"/>	The primary screening is inconclusive; potential wetlands should be further studied.

D. Supporting Documentation

The best available information such as NRCS Soil identification, Maps, USDA Plant Lists, previous USACE wetland determinations, if any, and/or documentation of project site (if available) must be provided to support the determination made. All supporting documentation must provide source reference.

Field Study photos, photo log, and georeferenced document demonstrating location of all boring sample must be included in this form.

Econo Energy Project
Project ID: IPGM-00375

Address: State Road PR-3, Int. PR 9959, Km. 15.21 Bo. Canovanillas, Canóvanas, PR. 00729

Coordinates: 18.373613° -65.906549°

Photos of existing site conditions



Rooftop where PV panels will be installed



Area for Liquefied
Natural Gas tank and
auxiliary equipment

Photo showing the area where Liquefied Natural Gas (LNG) tank and equipment will be installed.



Utilities area showing area where the new equipment and control room will be located.



Ground-level photo showing the area next to the building where the existing emergency-power generator units are located and where new equipment will be located.



Ground-level photo showing the area where the Photo showing the area where Liquefied Natural Gas (LNG) tank and its equipment will be installed.



Cooling towers.



Area for liquefied natural gas tank, auxiliary equipment, and drying beds.

Appendix 16

Wild and Scenic Rivers

Econo Energy Project

Project ID: IPGM-00375

Address: State Road PR-3, Int. PR 9959, Km. 15.21 Bo.

Canovanillas, Canóvanas, PR. 00729

Coordinates: 18.373613° -65.906549° 

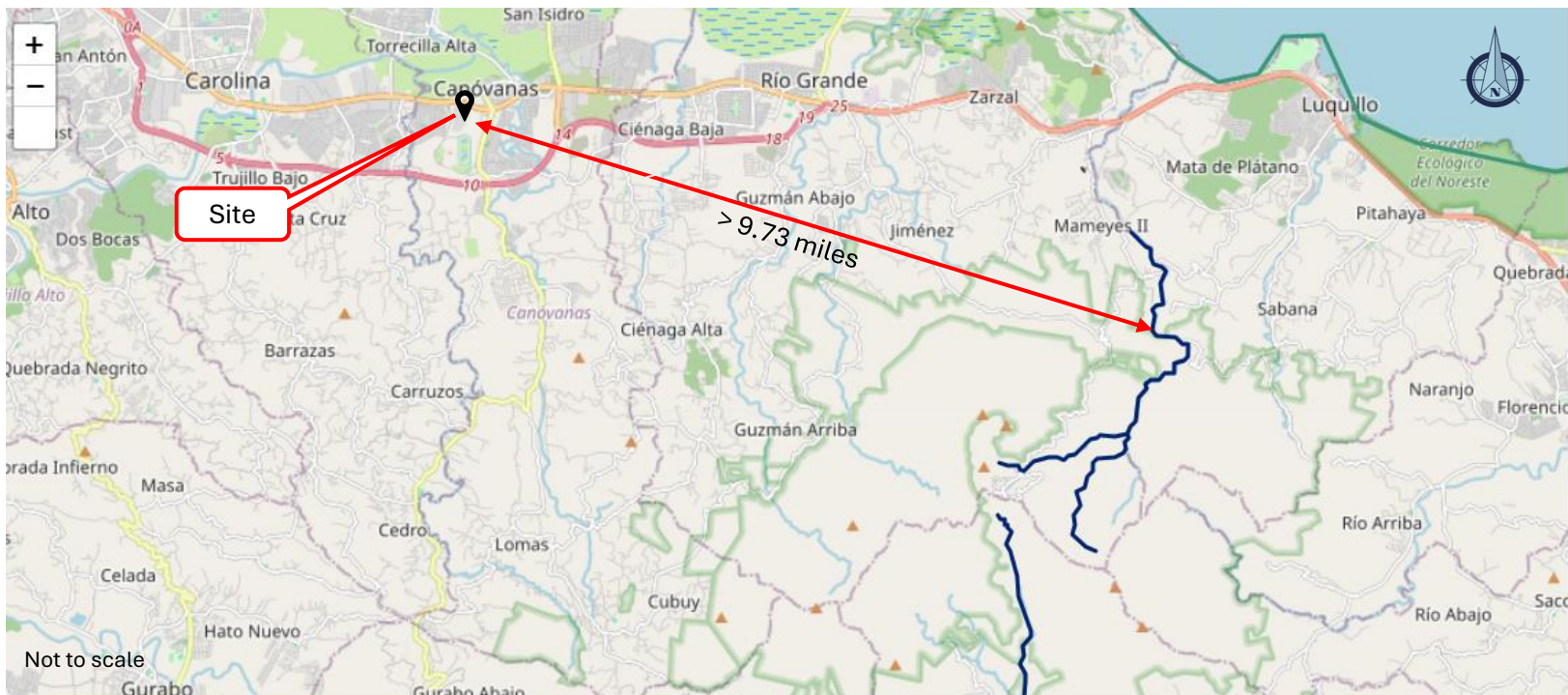

Appendix 17

Environmental Justice data



EJScreen Community Report

This report provides environmental and socioeconomic information for user-defined areas, and combines that data into environmental justice and supplemental indexes.

Econo Distr. Center

1 mile Ring Centered at 18.373207,-65.904988

Population: 11,726

Area in square miles: 3.14



August 25, 2024
Econo Distr. Center
1:18,000
0 0.2 0.4 0.6 0.8 1.0 1.2 1.4 1.6 1.8 2.0 2.2 2.4 2.6 2.8 3.0 3.2 3.4 3.6 3.8 4.0 4.2 4.4 4.6 4.8 5.0
0 0.33 0.65 1.33 km
Evo. HERE, Garmin, ICF, Mapbox

COMMUNITY INFORMATION

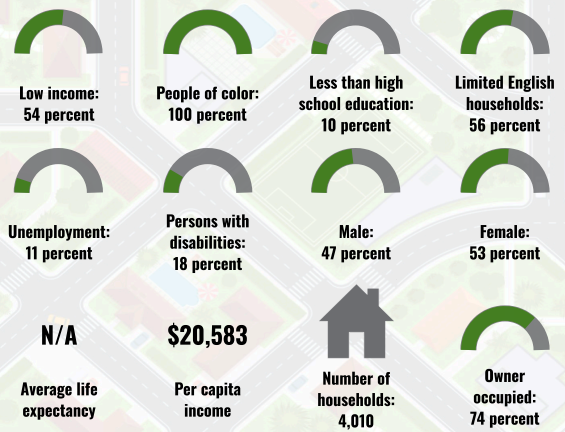

BREAKDOWN BY RACE

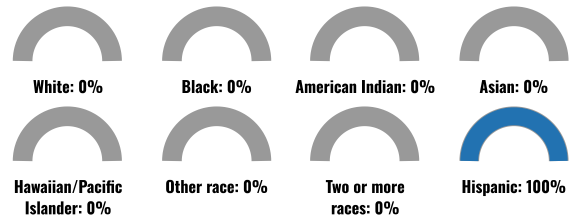

BREAKDOWN BY AGE



LIMITED ENGLISH SPEAKING BREAKDOWN



Notes: Numbers may not sum to totals due to rounding. Hispanic population can be of any race. Source: U.S. Census Bureau, American Community Survey (ACS) 2018-2022. Life expectancy data comes from the Centers for Disease Control.

LANGUAGES SPOKEN AT HOME

LANGUAGE	PERCENT
English	5%
Spanish	95%
Total Non-English	95%

Report for 1 mile Ring Centered at 18.373207,-65.904988

Report produced August 25, 2024 using EJScreen Version 2.3

Environmental Justice & Supplemental Indexes

The environmental justice and supplemental indexes are a combination of environmental and socioeconomic information. There are thirteen EJ indexes and supplemental indexes in EJScreen reflecting the 13 environmental indicators. The indexes for a selected area are compared to those for all other locations in the state or nation. For more information and calculation details on the EJ and supplemental indexes, please visit the [EJScreen website](#).

EJ INDEXES

The EJ indexes help users screen for potential EJ concerns. To do this, the EJ index combines data on low income and people of color populations with a single environmental indicator.

EJ INDEXES FOR THE SELECTED LOCATION

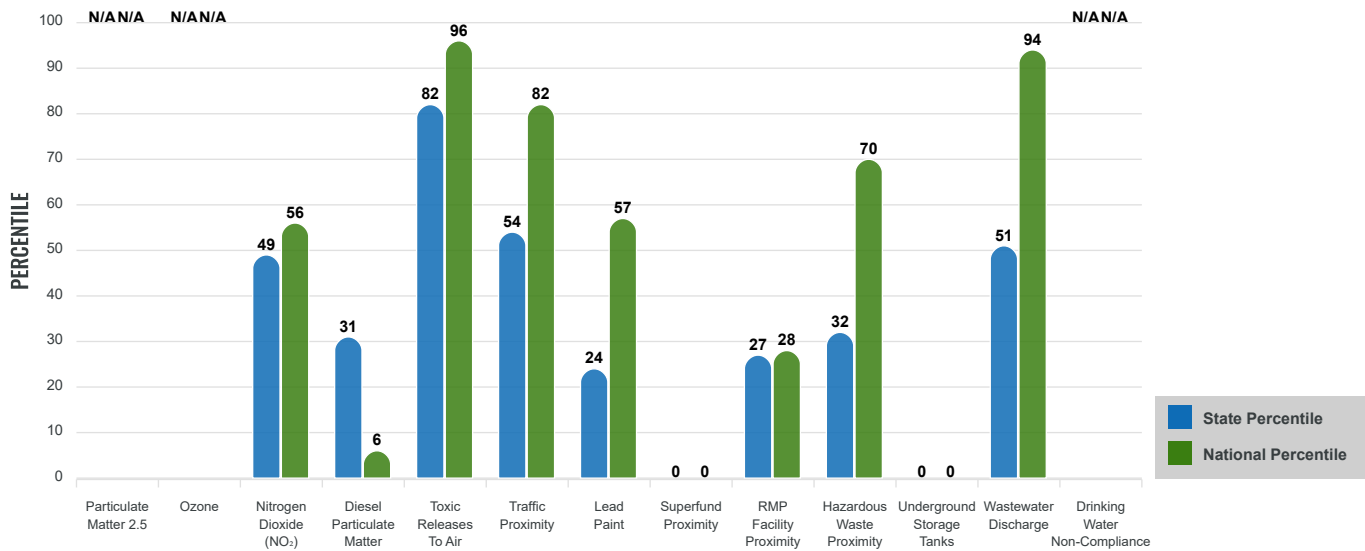

SUPPLEMENTAL INDEXES

The supplemental indexes offer a different perspective on community-level vulnerability. They combine data on percent low income, percent persons with disabilities, percent less than high school education, percent limited English speaking, and percent low life expectancy with a single environmental indicator.

SUPPLEMENTAL INDEXES FOR THE SELECTED LOCATION

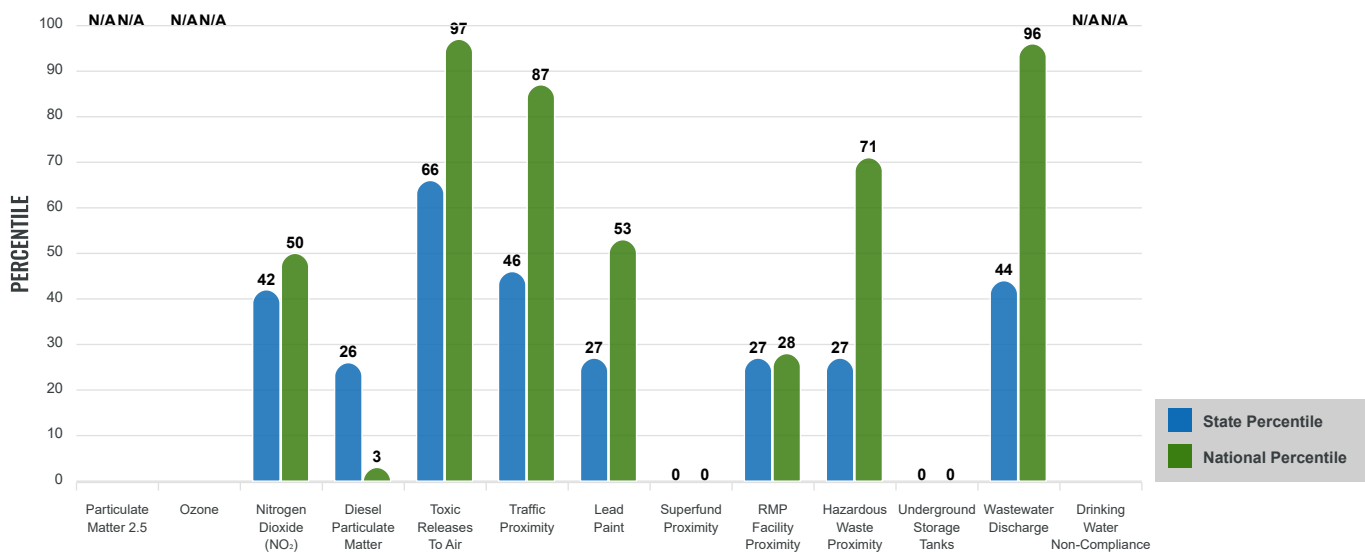

Report for 1 mile Ring Centered at 18.373207,-65.904988

Report produced August 25, 2024 using EJScreen Version 2.3

EJScreen Environmental and Socioeconomic Indicators Data

SELECTED VARIABLES	VALUE	STATE AVERAGE	PERCENTILE IN STATE	USA AVERAGE	PERCENTILE IN USA
ENVIRONMENTAL BURDEN INDICATORS					
Particulate Matter 2.5 (µg/m ³)	N/A	N/A	N/A	8.45	N/A
Ozone (ppb)	N/A	N/A	N/A	61.8	N/A
Nitrogen Dioxide (NO ₂) (ppbv)	4.8	5.5	52	7.8	21
Diesel Particulate Matter (µg/m ³)	0.0239	0.0618	33	0.191	1
Toxic Releases to Air (toxicity-weighted concentration)	3,400	4,300	91	4,600	81
Traffic Proximity (daily traffic count/distance to road)	820,000	1,100,000	57	1,700,000	50
Lead Paint (% Pre-1960 Housing)	0.087	0.16	48	0.3	33
Superfund Proximity (site count/km distance)	0	0.23	0	0.39	0
RMP Facility Proximity (facility count/km distance)	0.00052	0.66	27	0.57	28
Hazardous Waste Proximity (facility count/km distance)	0.47	1.2	35	3.5	33
Underground Storage Tanks (count/km ²)	0	0	0	3.6	0
Wastewater Discharge (toxicity-weighted concentration/m distance)	840	670000	54	700000	72
Drinking Water Non-Compliance (points)	N/A	N/A	N/A	2.2	N/A
SOCIOECONOMIC INDICATORS					
Demographic Index USA	2.85	N/A	N/A	1.34	93
Supplemental Demographic Index USA	3.17	N/A	N/A	1.64	97
Demographic Index State	4.37	4.63	19	N/A	N/A
Supplemental Demographic Index State	2.02	2.72	15	N/A	N/A
People of Color	100%	97%	29	40%	97
Low Income	54%	70%	18	30%	84
Unemployment Rate	12%	14%	53	6%	87
Limited English Speaking Households	56%	66%	23	5%	98
Less Than High School Education	10%	20%	22	11%	57
Under Age 5	3%	3%	56	5%	34
Over Age 64	17%	23%	28	18%	54

*Diesel particulate matter index is from the EPA's Air Toxics Data Update, which is the Agency's ongoing, comprehensive evaluation of air toxics in the United States. This effort aims to prioritize air toxics, emission sources, and locations of interest for further study. It is important to remember that the air toxics data presented here provide broad estimates of health risks over geographic areas of the country, not definitive risks to specific individuals or locations. More information on the Air Toxics Data Update can be found at: <https://www.epa.gov/haps/air-toxics-data-update>.

Sites reporting to EPA within defined area:

Superfund	0
Hazardous Waste, Treatment, Storage, and Disposal Facilities	0
Water Dischargers	11
Air Pollution	2
Brownfields	5
Toxic Release Inventory	2

Other community features within defined area:

Schools	3
Hospitals	0
Places of Worship	0

Other environmental data:

Air Non-attainment	No
Impaired Waters	Yes

Selected location contains American Indian Reservation Lands*	No
Selected location contains a "Justice40 (CEJST)" disadvantaged community	Yes
Selected location contains an EPA IRA disadvantaged community	Yes

Report for 1 mile Ring Centered at 18.373207,-65.904988
 Report produced August 25, 2024 using EJScreen Version 2.3

EJScreen Environmental and Socioeconomic Indicators Data

HEALTH INDICATORS

INDICATOR	VALUE	STATE AVERAGE	STATE PERCENTILE	US AVERAGE	US PERCENTILE
Low Life Expectancy	N/A	N/A	N/A	20%	N/A
Heart Disease	N/A	N/A	N/A	5.8	N/A
Asthma	N/A	N/A	N/A	10.3	N/A
Cancer	N/A	N/A	N/A	6.4	N/A
Persons with Disabilities	17.7%	22.7%	24	13.7%	77

CLIMATE INDICATORS

INDICATOR	VALUE	STATE AVERAGE	STATE PERCENTILE	US AVERAGE	US PERCENTILE
Flood Risk	N/A	N/A	N/A	12%	N/A
Wildfire Risk	N/A	N/A	N/A	14%	N/A

CRITICAL SERVICE GAPS

INDICATOR	VALUE	STATE AVERAGE	STATE PERCENTILE	US AVERAGE	US PERCENTILE
Broadband Internet	9%	29%	10	13%	48
Lack of Health Insurance	8%	7%	74	9%	59
Housing Burden	No	N/A	N/A	N/A	N/A
Transportation Access Burden	No	N/A	N/A	N/A	N/A
Food Desert	No	N/A	N/A	N/A	N/A

Report for 1 mile Ring Centered at 18.373207,-65.904988

Report produced August 25, 2024 using EJScreen Version 2.3

Appendix 18

Zoning and land use

Econo Energy Project

Project ID: IPGM-00375

Address: State Road PR-3, Int. PR 9959, Km. 15.21 Bo.

Canovanillas, Canóvanas, PR. 00729

Coordinates: 18.373613° -65.906549°

